



BM Elite Veterinary Multiparameter Monitor Series

Featuring the

BM3Vet Elite / BM5Vet Elite / BM7Vet Elite

Instructions for use



BM3Vet Elite

BM5Vet Elite

BM7Vet Elite

Ver. 5.04

2023.10.12



www.ebionet.com

REVISION HISTORY

Revision No.	Date	Contents	Page
5.00	2021.05.26	1. First Written	ALL
5.01	2021.02.11	1. Change model name	
5.02	2022.02.11	1. Missing marks and silk 2. Change representative number 3. Overall modification through design verification	ALL
5.03	2023.05.10	1. Bionet logo change 2. Updated supportable wfii dongle references 3. revision & date, version update	ALL 43p 1p
5.04	2023.10.12	1. Copyright text modification	

Table Of Contents

How to reach us	10
Introduction	11
Overview	11
Applications and Scope	12
Functional Safety.....	12
Warnings, Cautions and Notes.....	12
Definition of groups	13
General Precautions on Environment	14
Electromagnetic Compatibility	14
1. Basic	16
Overview	16
Electric Safety Precautions	16
Equipment Connection.....	17
Biocompatibility	18
Product Configuration	18
Basic Unit.....	20
Device Markings.....	28
Power.....	29
Getting Started.....	34
2. Setup	39
Overview.....	39
Monitor Configuration	39
Main Menu Setup	39

3. Network	44
Overview	44
Network Connection	44
IT Network Connection	47
LAN Network	47
VLAN Network	48
Inappropriate Network	48
Bed-to-Bed Viewing	49
4. Admission and Discharge	53
Overview	53
Animal Admission	53
Animal Discharge	53
Registration of Animal ID using barcode	55
5. Alarm	57
Overview	57
Alarm Priority	57
Alarm Management	59
Alarm Settings	60
Alarm Event(Physiological Alarm Review)	62
6. Trend	63
Overview	63
Trend Setting	63
Graphical Trend	64
Tabular Trend	66
File Export	67

Popup Tend	68
7. ECG	72
Overview	72
ECG Precaution	73
Animal Preparation	75
Connector and Measurement cable	76
ECG Lead	78
ECG Signal Processing and Display	79
ST Signal Processing and Display	80
Alarm and Alarm Status	80
Display	80
ECG Settings	81
Trouble Shooting	83
8. Arrhythmia Monitoring	84
Overview	84
Arrhythmia Template	84
Arrhythmia Settings	85
9. Respiration	87
Overview	87
RESP Precaution	87
Animal Preparation	87
Display	88
Respiration settings	88
10. SpO2	90
Overview	90

Precaution.....	90
Animal preparation.....	90
Connector and Measurement Cable.....	91
Display.....	93
Signal and Data Validity	94
SPO2 Settings	95
SpO2 Status Messages.....	96
Cleaning	96
11. NIBP	98
Overview.....	98
Connector and Cuff	98
Display.....	101
NIBP Settings.....	101
Measurement Limitations.....	104
Cuff Selection and Placement	104
Status Messages.....	105
12. Temperature	106
Overview.....	106
Connector and Measurement Cable.....	106
Display.....	107
Temperature Settings.....	108
13. EtCO2	110
Overview.....	110
Precaution.....	110
Connector and Measurement Accessory.....	111

Display.....	113
Sampling Method	113
EtCO2 Settings.....	115
Status Message.....	118
CO2 measurement failure.....	119
14. Invasive Blood Pressure	121
(BM5Vet Elite/BM7Vet Elite only)	121
Overview.....	121
Precaution.....	121
Connector and measurement kit	122
Display.....	124
Procedures.....	124
IBP Settings.....	126
Trouble Shooting.....	127
15. Printer.....	128
Overview.....	128
Printer Settings.....	128
Thermal Paper Storage	129
Paper Change.....	130
16. Maintenance and Troubleshooting	131
Inspection of equipment	131
Inspection of cables.....	131
Maintenance task and test schedule.....	132
Trouble shooting	133
17. Clean and Care.....	141

Overview.....	141
Monitor, Modules and Accessories.....	141
18. Technical Specification	145
Overview.....	145
EMC Compatibility (EMC).....	145
Manufacturer's Declaration - Electromagnetic Emission	146
Manufacturer's Declaration - Electromagnetic Immunity.....	147
System Specification.....	150
Arrhythmia Alarm Default Level	155
Parameter Alarm Default Level	156
Parameter Alarm Default Setting Value and Setting Range.....	165
Technical Alarm Default Level	177
Abbreviations and Symbols	179
Abbreviations.....	179
Symbols.....	182
PRODUCT WARRANTY	오류! 책갈피가 정의되어 있지 않습니다.

Warning

Please read this instructions for use before operating this medical equipment and keep it for future reference.

BM3Vet Elite / BM5Vet Elite / BM7Vet Elite User Manual

Copyright©Bionet Co.,Ltd.



Copyright Ownership.

No part of this manual may be reproduced, stored in or introduced into a retrieval system, or transmitted, in any form, or by any means, without the prior written permission of the copyright owner Bionet.

The entire manual should be carefully read.

This manual contains information on limitations, warnings, and cautions regarding product use and function of the equipment.

Regardless of the complexity of the equipment, veterinary multiparameter monitoring equipment should never be used to replace human care, attention and important judgment that can only be provided by trained health professionals.

CAPNOSTAT, LoFlo® are trademarks of Respironics.

All other brand or product names are the property of their respective owners.

How to reach us

BIONET services are always available to you.

The followings are address and phone number for contacting information, services, and product supplies.

However, the service is limited for genuine products only. Service may not be provided for other cases.

Product Supply Information	Bionet Co., Ltd. – Sales Department Address #5F, 61 Digital-ro 31 gil, Guro-gu, Seoul, REPUBLIC OF KOREA (ZIP 08375) Overseas sales dept. TEL : 82-70-7585-6465 (International) 82-2-6292-6410 (Domestic) FAX : +82-2-6499-7789 E-mail : info.sales@ebionet.com URL : http://www.ebionet.com
Consumables Order	Bionet Co., Ltd. – Sales Department TEL : 82-70-7585-6465 (International) 82-2-6292-6410 (Domestic) FAX : 82-2-6499-7789 E-mail : info.sales@ebionet.com URL : http://www.ebionet.com Any Authorized Bionet Distributor http://www.bionetus.com/locate-a-dealer
A/S and Technical Support	Bionet Co., Ltd. – Customer Service Department TEL : 82-80-801-6410 FAX : 82-2-6499-7788 E-mail : service@ebionet.com
Internet	URL : http://www.ebionet.com

* In the event of malfunction or failure, contact us along with the model name, serial number, and product name of the product.

Introduction

BM3Vet Elite / BM5Vet Elite / BM7Vet Elite Veterinary Multiparameter Monitors are multi-parameter instruments designed for monitoring the vital physiological signs of animals.

BM3Vet Elite / BM5Vet Elite / BM7Vet Elite Veterinary Multiparameter Monitors offers visual and audible monitoring alarms when the values exceed the preset normal ranges.

It allows comprehensive analysis of animal's physiological conditions.

This Veterinary Multiparameter Monitor can be connected to BT-Link which is a Windows-based central monitoring and recording software.

Note

All Bionet hardware drawings and screenshots on this user manual use for an example only. The actual product can be slightly different from drawings and screenshots.

Overview

BM3Vet Elite / BM5Vet Elite / BM7Vet Elite Veterinary Multiparameter Monitors can monitor the parameters listed below.

- Heart Rate
- Respiration Rate
- Non-Invasive blood pressure
- Arrhythmia
- Temperature (BM3Vet Elite: 1 Temperature, BM5Vet Elite / BM7Vet Elite: 2 Temperatures)
- SpO2
- Pulse Rate
- Apnea
- ST segment analysis
- EtCO2(option)
- FiO2(option)
- 2 Chanel Invasive blood pressure (BM5Vet Elite, BM7Vet Elite only)

Caution

BM3Vet Elite / BM5Vet Elite / BM7Vet Elite Veterinary Multiparameter Monitors are applicable for use in hospitals and clinical institutions. The operation should be performed by qualified professionals only.

Applications and Scope

BM3Vet Elite / BM5Vet Elite / BM7Vet Elite Veterinary Multiparameter Monitor is a multi-functional instrument designed for monitoring the vital physiological signs of canines, felines, and equines.

Functional Safety

The essential function of the Veterinary Multiparameter Monitor is to provide clinicians with meaningful parameter values.

The alarm occurs when the parameter value is out of the specified value or the function that provides the parameter value does not work properly.

Bionet assessed the risk of using Veterinary Multiparameter Monitors by considering these essential functions and it has mitigated the risk of product life under the condition that it is used in compliance with service recommendations and regular maintenance.

Warnings, Cautions and Notes

Read the "**Warnings, Cautions and Notes**" thoroughly before use to ensure correct and safe use of product.

Be sure to follow the "Warnings, Cautions and Note" indicated below, as these are important message related to safety.

Bionet reserves the right to improve and amend it at any time without prior notice.

Warning	[Warning] Failure to follow this message may result in death or serious injury or complete failure of the equipment.
Caution	[Caution] Failure to follow this message may cause injury or failure to the equipment.
Note	[Note] indicates some important information and tips about operations and application.

Definition of groups

Bionet defines groups as users, service personnel, and experts for using of this product.

All defined groups should read this user manual very carefully before operating this equipment and should be trained in the use, installation, reprocessing, maintenance, and repair of the product.

This product can be used, installed, reprocessed, maintained, and repaired by defined groups only.

User

Users use the product for their intended use.

Service personnel

Service personnel are responsible for the maintenance of the product.





They must be trained in the maintenance of the medical device, install, reprocess, and maintain the product.

Expert

The specialist repairs the product or performs complex maintenance tasks. The expert has the knowledge and experience to perform complex maintenance tasks on your product.

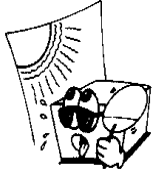
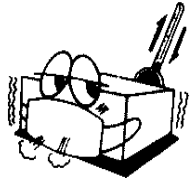
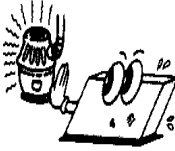
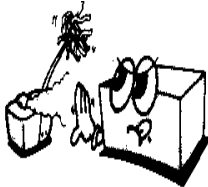
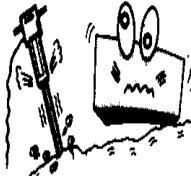
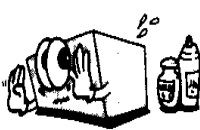
General Precautions on Environment

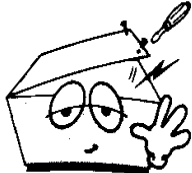
Do not keep or operate the equipment in the environment listed below

	<p>Avoid placing in an area exposed to moisture.</p> <p>Do not touch the equipment with wet hands.</p>		<p>Avoid exposure to direct sunlight</p>
	<p>Avoid placing in an area where there is a high variation of temperature.</p>		<p>Avoid placing in the vicinity of Electric heaters</p>
	<p>Avoid placing in an area where there is an excessive humidity rise or ventilation problem.</p>		<p>Avoid placing in an area where there is excessive shock or vibrations.</p>
	<p>Avoid placing in an area where chemicals are stored or where there is danger of gas leakage.</p>		<p>Avoid inserting dust and especially metal material into the equipment</p>
	<p>Do not disjoint or disassemble the equipment.</p>		<p>Power off when the equipment is not fully installed.</p> <p>Otherwise, equipment could be damaged.</p>

Electromagnetic Compatibility

The monitor has been designed and tested for compliance with current regulatory standards as to its capacity to limit electromagnetic emission (EMI), and also as to its ability to block the effects of EMI from external sources.

The monitor complies with the following standards pertaining to EMI emissions and susceptibility: EN60601-1-2.

To reduce possible problems caused by electromagnetic interference, we recommend the following:

- Use only Bionet approved accessories.
- Ensure that other products used in areas where veterinary multiparamter monitoring and life support is used comply to accepted emissions standards (CISPR 11, Class A).
- Try to maximize the distance between electro-medical devices. High-power equipment related to electrical simulators, electrosurgical instruments, and radiators (X-ray machines) as well as evoked potential devices may cause monitor interference.
- Strictly limit exposure and access to portable radio frequency sources (e.g., cellular phones and radio transmitters). Be aware that portable phones may periodically transmit even when in standby mode.
- Maintain good cable management. Do not route cables over electrical equipment. Do not intertwine cables.
- Ensure all electrical maintenance is performed by qualified personnel.

Caution**Infectious devices and parts must be sanitized and cleaned before disposal.**

1. Basic

Overview

This Veterinary Multiparameter Monitor is for canines, felines, and equines. It can be used as an independent device or connected to the BT-Link central monitoring system. Use of the monitor is limited to one animal at a time.

The following optional software features are available:

- Arrhythmia analysis.
- 3-lead ST segment analysis.
- Wireless network connection.
- It is common to connect B2B VIEWS, and the two connections are optional.

Electric Safety Precautions

Caution	Please check the following before using the product.
	1. Be sure that AC power supply line is appropriate to use. (AC100 - 240V)
	2. Be sure that the power source is the one supplied from Bionet.
	3. Be sure that the entire connection cable of the system is properly and firmly fixed.
	4. Be sure that the equipment is completely grounded.
	5. The equipment should not be placed in the vicinity of electric generators X-rays, or Broadcasting apparatus to eliminate the electric noise during operation. Otherwise, it may cause incorrect results.

Caution	The Equipment should be placed far from generators, X-ray equipment, broadcasting equipment or transmitting wires, so to prevent electrical noises from being generated during the operation when these devices are near the Equipment, it can produce inaccurate measurements. For BM series Veterinary Multiparameter Monitors both independent circuit and stable grounding are essentially required. In the event that the same power source is shared with other electronic equipment, it can also produce inaccurate output.
----------------	--

Note	<p>BM3Vet Elite, BM5Vet Elite, BM7Vet Elite are classified as follows:</p> <ul style="list-style-type: none"> - BM3Vet Elite, BM5Vet Elite, BM7Vet Elite classifies as Class I, BF & CF concerning electric shock. It is not proper to operate this Equipment around combustible anesthetic or dissolvent. - Noise level is A class regarding IEC/EN 60601-1, and the subject of Noise is A level concerning IEC/EN60601-1-2.
-------------	---

Warning	Do not touch the animal while using a defibrillator. The user may be at risk. When using a defibrillator, be careful about safety and use only the supplied cable.
----------------	--

Warning	In case the Equipment does not operate as usual or is damaged, do not use on animals, and contact the medical equipment technician of the hospital or the equipment supply division.
----------------	--

Equipment Connection

Caution	Doctors and animals in hospitals are exposed to the risk of uncontrollable currents. This current is caused by a potential difference between the equipment and a conductive object that can be contacted. Use auxiliary equipment to meet this requirement in accordance with EN60601-1.
----------------	---

Biocompatibility

When used as intended, the parts of the product described in this operator manual, including accessories that come in contact with the animal during the intended use, fulfill the biocompatibility requirements of the applicable standards. If you have questions about this matter, please contact Bionet or its representatives.

Product Configuration

Basic components

1. Main body of BM3Vet Elite/BM5Vet Elite/BM7Vet Elite monitor	1 EA
2. 3-Lead ECG patient cable	1 EA
3. Disposable electrodes	10 EA
4. NIBP extension tube	1 EA
5. Vet NIBP cuff (#1~#5)	1 SET
6. SpO2 extension cable	1 EA
7. Reusable multi-site SpO2 probe	1 EA
8. DC power adaptor	1 EA
9. Operation manual	1 EA
10. Thermal roll paper	2 ROLL
11. Rechargeable battery	1 EA

Optional components

1. Reusable temperature probe (Skin type)
2. Sidestream EtCO2 module (Respironics)
3. Mainstream EtCO2 module (Respironics)
4. Sidestream Dual Gas module
5. Sidestream EtCO2 sample lines
6. Mainstream EtCO2 airway adapters
7. Watertrap for Dual Gas module
8. Sample line for Dual Gas module
9. Airway adapters with luer lock interface
10. 5-Lead ECG patient cable
11. IBP transducer set (Disposable/Reusable) (BM5Vet Elite/BM7Vet Elite only)

Warning

In order to avoid electrical shock, do not open the cover. Disassembling of the equipment should be done only by the service personnel authorized by Bionet

Warning

Users must pay attention on connection any auxiliary device via LAN port or nurse calling. Always consider about summation of leakage current, please check if the auxiliary device is qualified by IEC 60601-1, or consult your hospital biomedical engineer.

Basic Unit

BM3Vet Elite

Front view

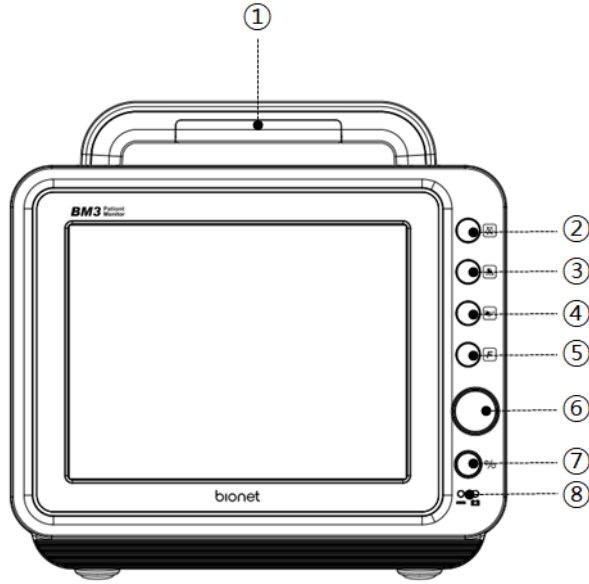

BM5Vet Elite

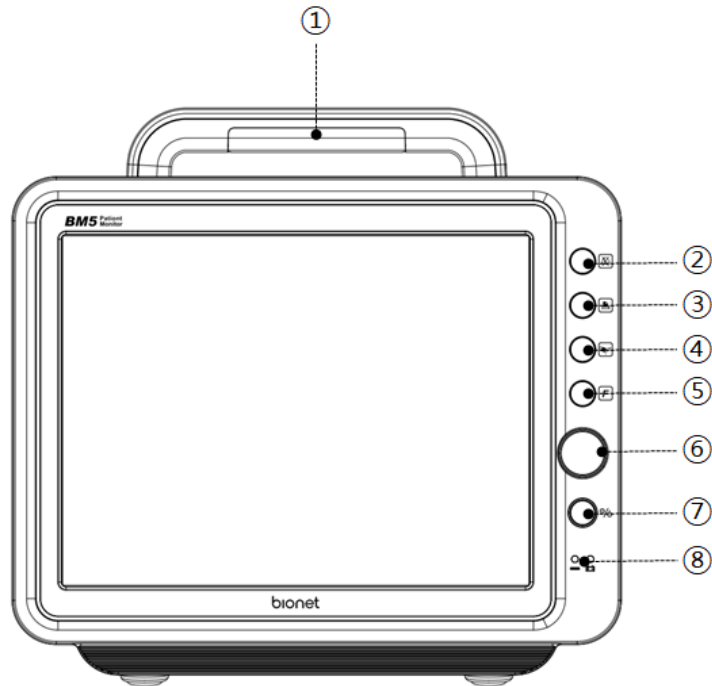

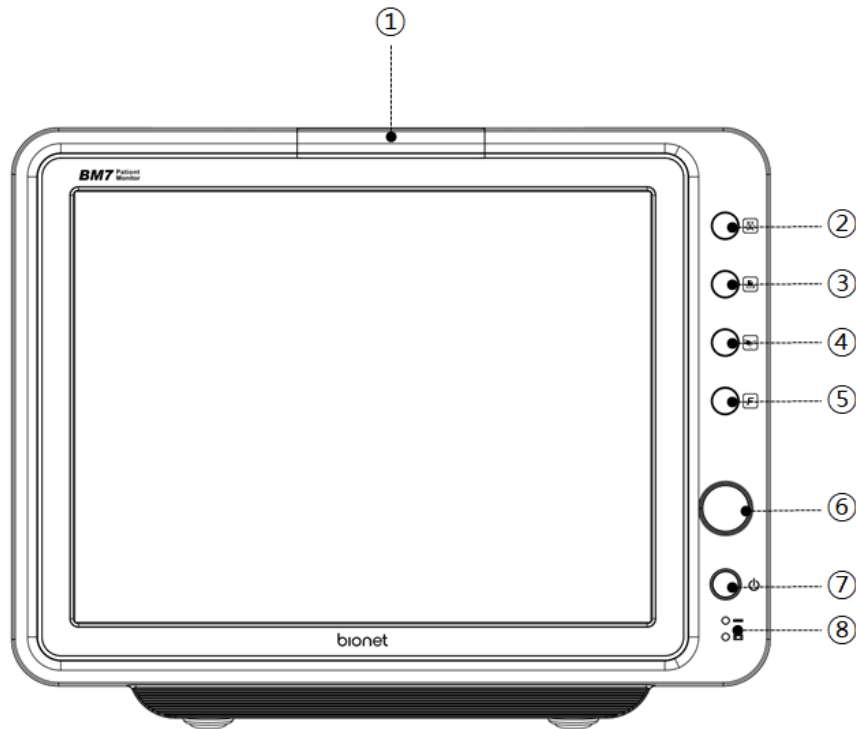
BM7Vet Elite

- ① Alarm lamp
- ② Alarm control key
- ③ Printer key
- ④ Blood pressure measurement key
- ⑤ Home key
- ⑥ Rotary knob
- ⑦ Power ON/OFF Key
- ⑧ Battery status indicator

Right side view

BM3Vet Elite

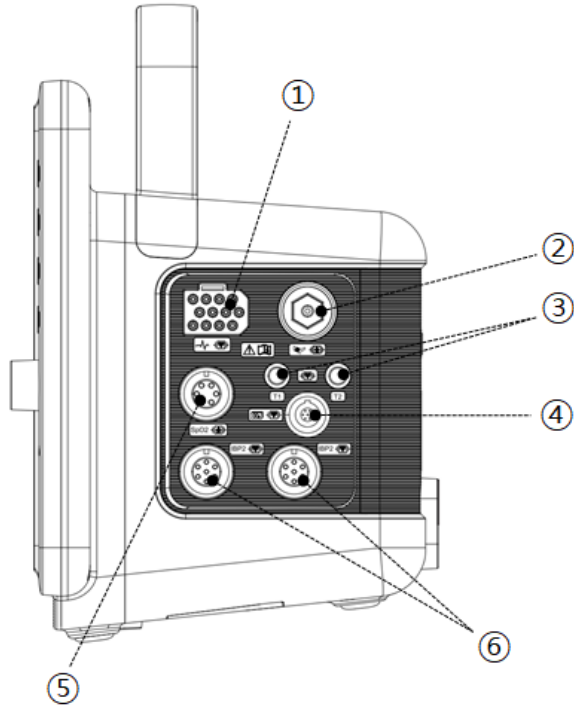

BM5Vet Elite

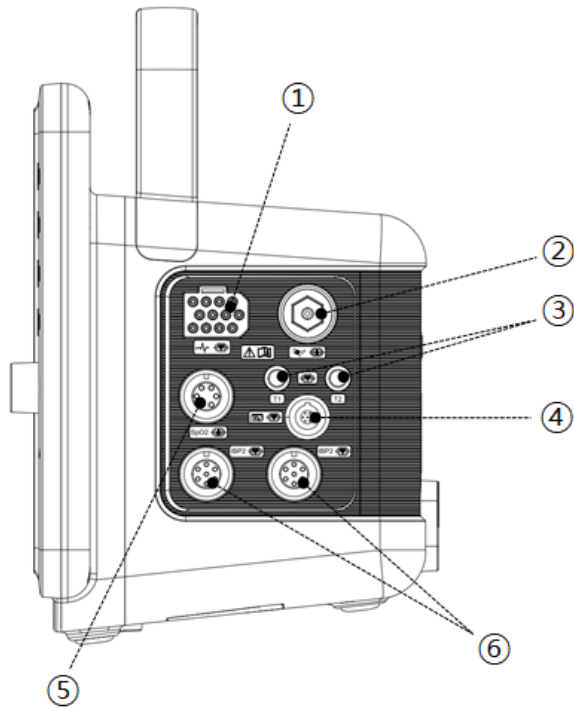

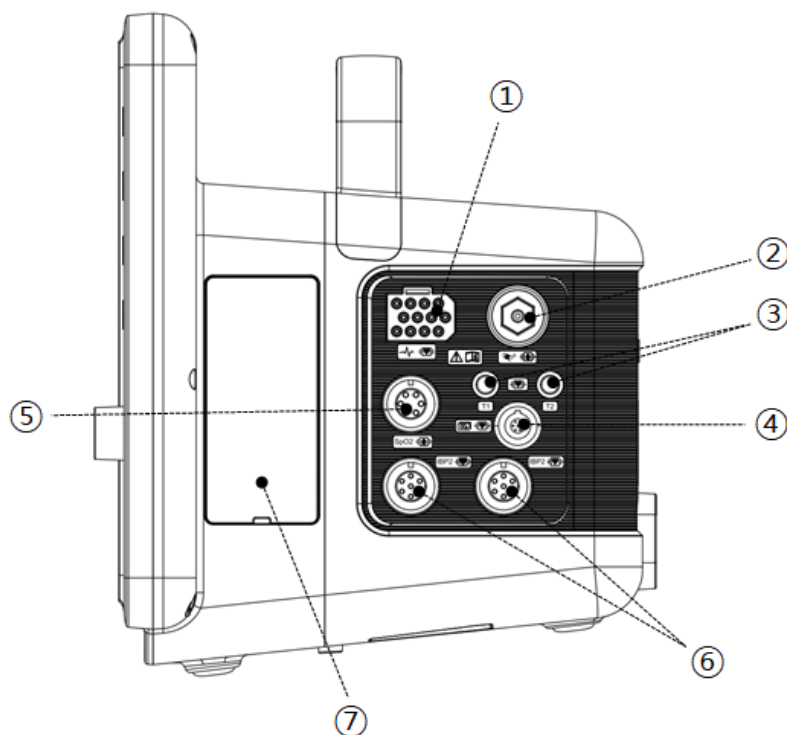
BM7Vet Elite

- ① ECG connector
- ② Blood pressure tube connector
- ③ Temperature connector
- ④ EtCO₂ connector
- ⑤ SpO₂ connector
- ⑥ IBP connector
- ⑦ Optional battery cover

Left side view

BM3Vet Elite

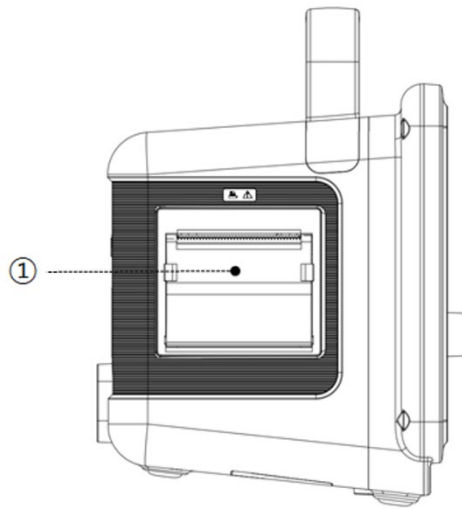

BM5Vet Elite

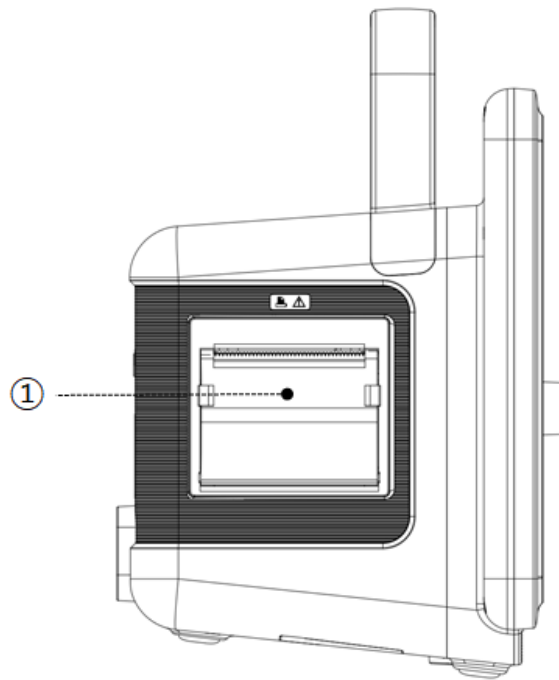

BM7Vet Elite

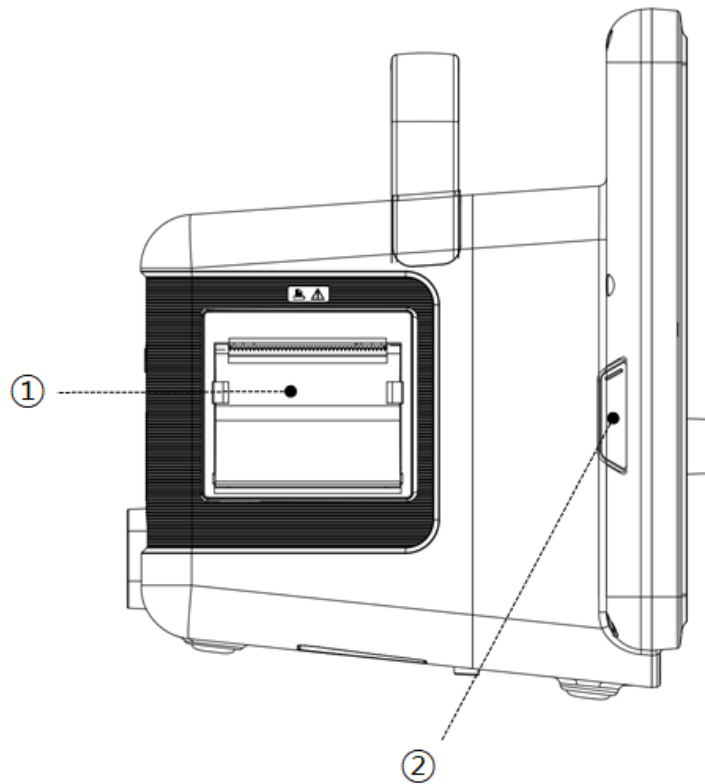

- ① Printer
- ② USB port

Rear view

BM3Vet Elite

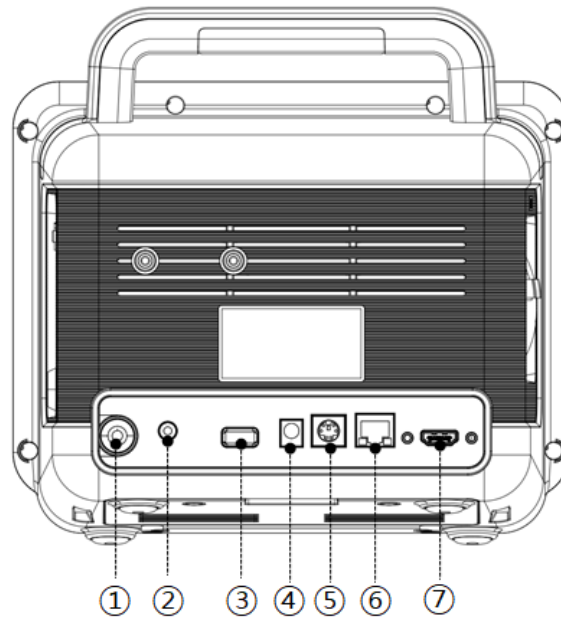

BM5Vet Elite

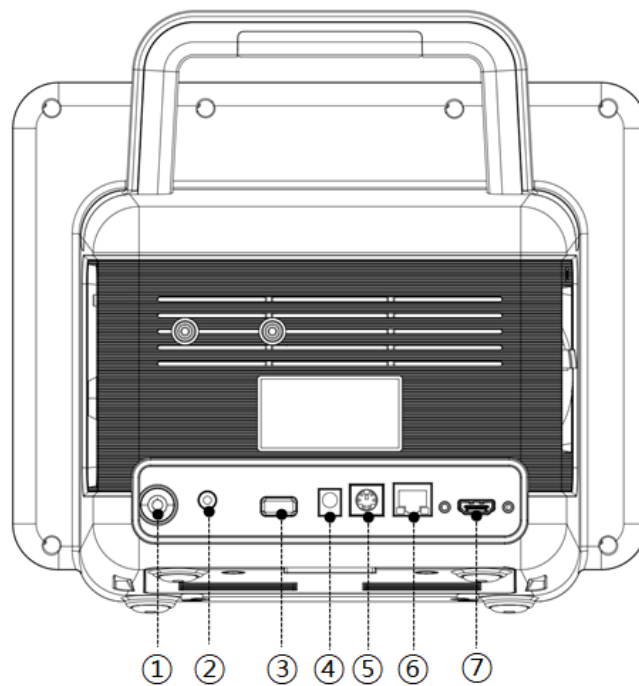

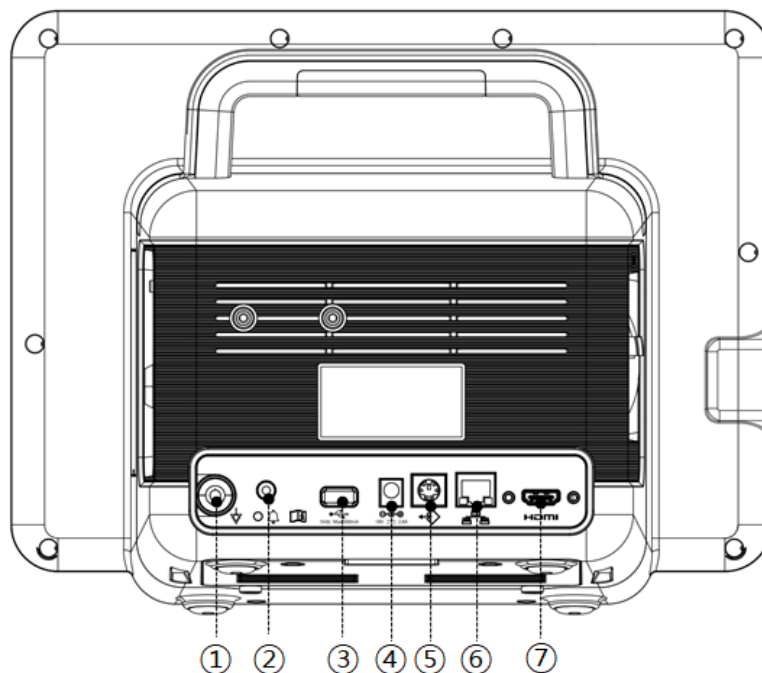









BM7Vet Elite













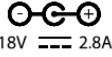
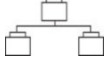





- ① Ground
- ② Nurse call connector
- ③ USB port (USB 2.0 5Vd / Max. 500mA)
- ④ DC input connector
- ⑤ Auxiliary port
- ⑥ LAN port
- ⑦ HDMI output port

Warning	USB compatible
	BM3Vet Elite / BM5Vet Elite / BM7Vet Elite Veterinary Multiparameter Monitors is compatible with external USB memory drives up to 64GB. We recommend the product brands listed in the manual (Sandisk, PNY, Transcend, Samsung).
	When using a product with high power consumption, such as an external hard drive, be sure to use the provided adapter for suitable power supply. (Monitor cannot be used alone as a power supply)
	You should save the data of connected device before connecting the additional device.
	High power devices may not be supported. .

Note	The HDMI output of (BM3Vet Elite, BM5Vet Elite) is 800x600 @59Hz and (BM7Vet Elite) is 1024x768 @60Hz.
	Depending on the specifications of the external monitor, it may not be displayed on the screen, so please check it beforehand.

Device Markings

	Caution : Consult accompanying documents		European Medical Device Directive 93/42/EEC
	Type CF applied part		Type BF applied part
	IP (Ingress Protection)		ECG
	Temperature		NIBP
	EtCO2		SpO2

	IBP		Ground terminal
 18V — 2.8A	DC input connector		LAN port
	Nurse call		Auxiliary Port
HDMI	HDMI external port		USB port
	Alarm Key		Printer Key
	NIBP Key		Function Key
	Power ON /OFF Key		Battery Operation indicator
	DC Input Indicator		WEEE (Waste Electrical and Electronic Equipment)
	Date of manufacture		Manufacturer
	Consult instructions for use. This symbol advises the reader to consult the operating instructions for information needed for the proper use of the device.		Safety Sign: To signify that the instruction manual must be read. Reading the instruction manual before starting work or before operating equipment.

Power

BM3Vet Elite / BM5Vet Elite / BM7Vet Elite Veterinary Multiparameter Monitors uses a DC power adaptor (100-240 VAC / 18VDC 2.8A). In the event of a power outage or cable shortage, the monitor automatically switches to battery power to continue veterinary multiparameter monitoring without data loss. The built-in battery is intended for back-up use only during power-off.

DC Adaptor information

Manufacture: BRIDGE POWER CORP.

Model name: BPM050S18F02

Input Power: 100~240V 1.5A

Output Power: 18 V, 2.8 A

DC Power LED is lighted on when the DC Power is plugged into the inlet at the back of the product. A press of power key makes the machine ready for use.

Caution	<p>This equipment must be connected to a protective earth grounded power supply.</p> <p>Using non-standard products other than the adapters supplied by us may cause signal distortion or noise. Be sure to use a genuine adapter that is supplied by our company and is insulated.</p> <p>Do not position the device in a place where it is difficult to unplug its power supply cord.</p>
----------------	--

Battery Power







It uses battery power when there is a power failure and for portable use.

The battery is attached to the bottom of the equipment.

Operation

1. Battery Power LED is lighted on when the machine is in use.
2. Battery is automatically charged when the machine is connected to DC Power Supply. The charging status is displayed at the top right of the screen.
3. The charging status of the batteries is displayed with 5 step diagrams

Battery status display		
Display	Charging remain time	Description

	The battery is charging	
	The battery is fully charged	
	The battery is 80% charged	
	The battery is 60% charged	If possible, connect it to the AC adapter.
	The battery is 40% charged	Immediately connect the monitor to the AC adapter.
	The battery is very low. (The power will turn off in about 2min.)	Immediately connect the monitor to the AC adapter.
	There is no battery.	Connect the battery.

Caution

The battery status is displayed correctly only when the battery is operating normally.

Note

When external power is not supplied, it takes about 15 seconds for the battery status display to reflect the actual remaining battery capacity.

Battery information

- Battery specification: Li-ion, 10.8V
3BL335-BIO-S (3250mAh) or 031PpTC3(3ICR19/65) (2150mAh) (BM3Vet Elite, BM5Vet Elite standard)
6BL335-BIO-S (6500mAh) (BM7Vet Elite standard, BM3Vet Elite/BM5Vet Elite optional)
- Battery charging time:
3BL335-BIO-S: More than 3 hours
6BL335-BIO-S: More than 5 hours
- Continuous battery usage time when fully charged:
BM3Vet Elite
- 3BL335-BIO-S: about 2 hours

- 6BL335-BIO-S: about 4 hours

BM5Vet Elite

- 3BL335-BIO-S: about 2 hours
- 6BL335-BIO-S: about 4 hours

BM7Vet Elite

- 6BL335-BIO-S: about 2 hours

* (measured every 15 minutes NiBP with SpO2 and ECG)

Warning	Older or defective batteries will have significantly reduced capacity or operating time.
----------------	---

Warning	<p>Be careful of the polarity when replacing the battery.</p> <p>We strongly recommend that you use the battery supplied by Bionet.</p> <p>Using unauthorized batteries may damage the equipment.</p> <p>Remove the battery if the equipment is not likely to be used for some time.</p>
----------------	--

Note	<p>The Lithium-Ion battery is a rechargeable battery containing Lithium-Ion cells. Each battery contains an integrated electronic fuel gauge and a safety protection circuit.</p>
-------------	--

Note	<p>To maximize the charge for transport, keep the monitor connected until you are ready to transport the animals. Reconnect the monitor immediately after transport.</p> <p>Bionet recommends replacing the lithium ion battery after 24 months of use.</p> <p>Battery life depends on usage. If battery use continues, battery life will decrease and frequency of replacement will increase.</p> <p>To prevent pre-discharge, recharge after the battery is discharged.</p>
-------------	---

Note	Charging is not possible at low power (below 16V).
	Cannot be used in vehicles with 24V power supply.
	When replacing the battery, be sure to remove the DC adapter and replace it.

How to replace the battery

Please assemble and replace as shown below.

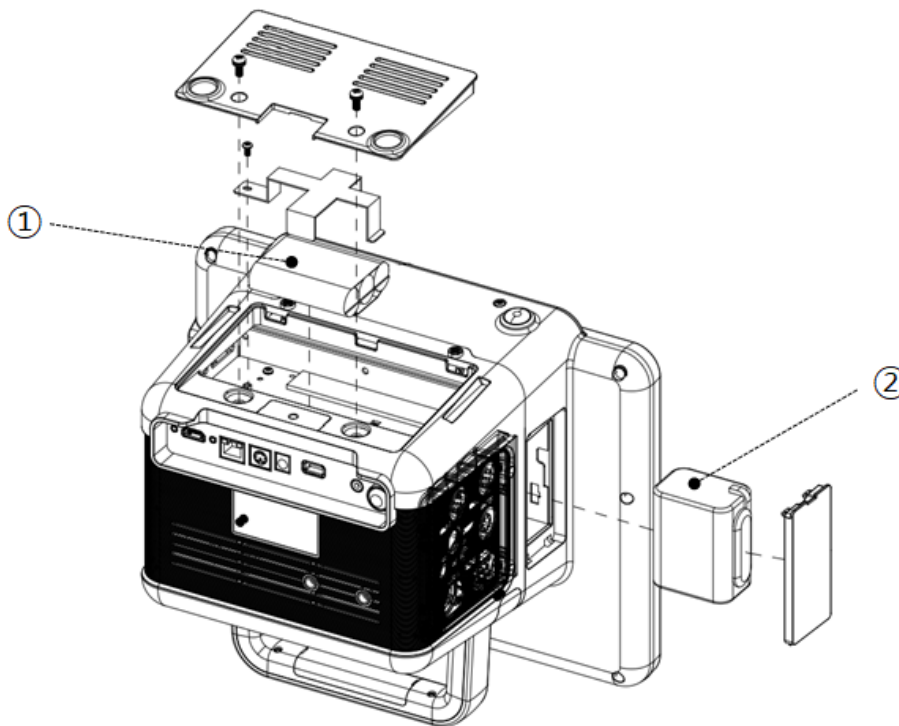

- ① Standard battery
- ② Additional option battery (BM7Vet Elite Only)

The Impact of Lithium-Ion Battery Technology on the Battery

The following are the key points you should know about Lithium-Ion battery technology:

The battery will discharge on its own, even when it is not installed in a monitor. This discharge is the result of the Lithium-Ion cells and the bias current required for the integrated electronics.

By the nature of Lithium-Ion cells, the battery will self-discharge.

The self-discharge rate doubles for every 10°C (18°F) rise in temperature.

The capacity loss of the battery degrades significantly at higher temperatures.

As the battery ages, the full-charge capacity of the battery will degrade and be permanently lost. As a result, the amount of charge that is stored and available for use is reduced.

Warning

When replacing the battery, only use the battery provided by Bionet. Check the battery is properly secured to the bracket. Do not cause a serious impact on the battery.

Ignoring the above warnings can cause battery explosion and serious damage to devices

Conditioning Guideline

The battery in the monitor should be fully charged and discharged every six months and condition it using the battery charger.

How to Recycle the Battery

When the battery no longer holds a charge, it should be replaced. The battery is recyclable. Remove the old battery from the monitor and follow your local recycling guidelines.

Warning

Serious injury from explosion may result.

If the battery has an external shock, external damage, or flooding, dispose of the battery without using it.

Getting Started**Starting the monitor:**

Press the power key at the bottom right of the monitor front panel. The power light on the monitor lights up, the alarm bar lights up, the power is turned on, the screen lights up, the main screen is displayed after running the self-test.

Stopping the monitor:

Press and hold the power key for 3 seconds. The screen goes off.

Main screen setup

After the monitor is turned on, the main screen is displayed.

BM3Vet Elite

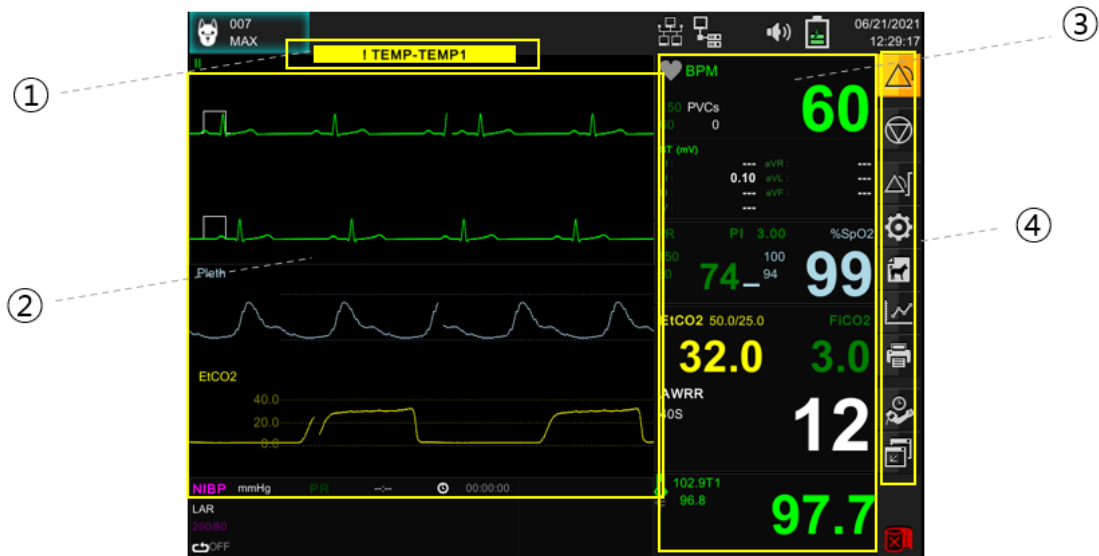

BM5Vet Elite

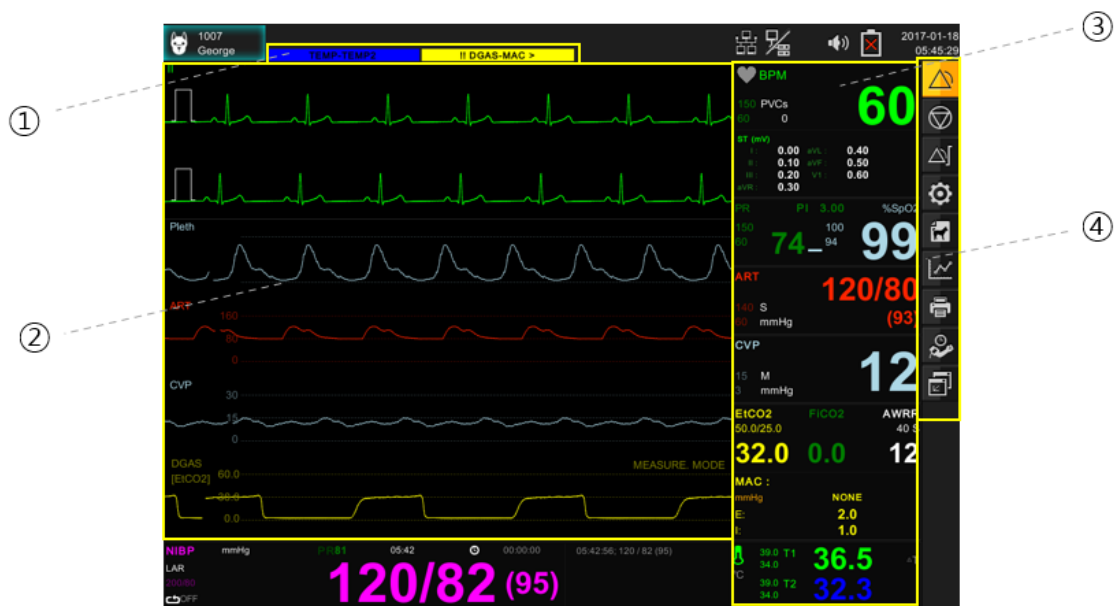

BM7Vet Elite

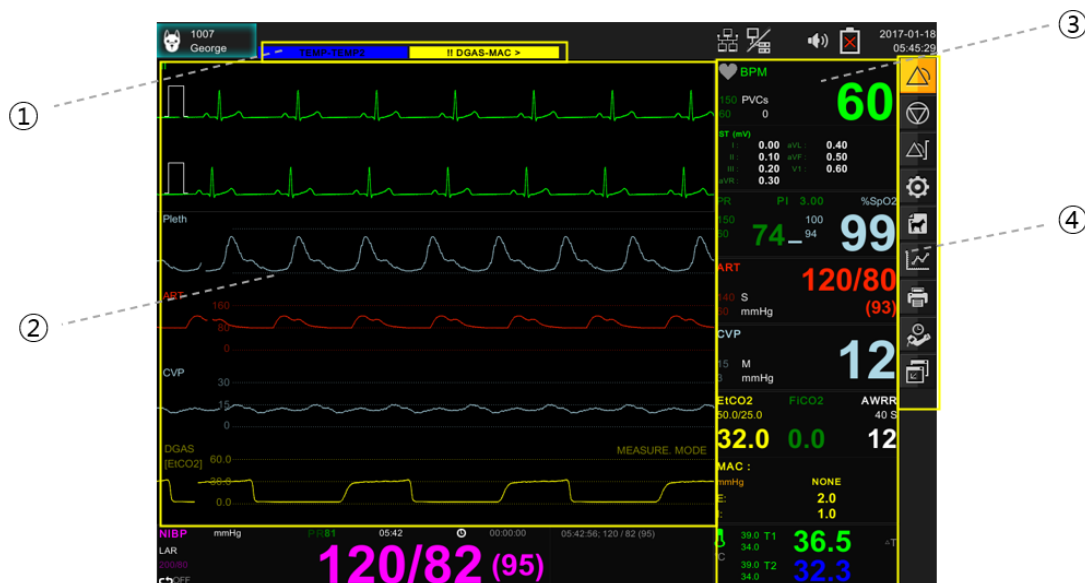

- ① Status Message
- ② Waveform Window (IBP1 & IBP2: BM5Vet Elite & BM7Vet Elite only)
- ③ Numeric Window (TEMP: 1 Channel for BM3Vet Elite, 2 Channel for BM5Vet Elite & BM7Vet Elite)
- ④ Menu Window

Main screen

The parameter box displays values, alarm limits and icons for the selected parameter. You can set the parameters and their associated waveforms so that they are easy to distinguish.







The message appears at the top of the screen. The animal's name bed label is displayed in the upper left corner of the screen. The top right of the screen displays the time, network, and device management status.

Rotary knob switch

The rotary knob switch allows the user to navigate menus, select settings, and perform menu functions. Rotate the rotary knob to move to the various menu items. To confirm the selection, press the rotary knob switch.



Fixed key









The fixed keys on the front panel of the monitor allow you to perform commonly performed functions.

Fixed key	Description	Fixed key	Description
	The alarm control key switches between Normal / Audio Paused and Alarm Paused mode. Press more than 3 seconds to switch to Audio Off or Alarm Off mode		Start or end non-invasive blood pressure (NIBP) measurements.
	Start or stop recording on the printer.		Return to the main screen or switch to the extended parameter screen mode.
 + 	Pressing the alarm control key and the home key simultaneously switches to the user input lock mode. In lockdown mode, all touch screens and key inputs except the power key are ignored. Press the alarm button and the home button simultaneously to unlock.		

Function key

On the right side of the monitor's front panel, the touch screen icon on the touch screen allows you to perform frequently-used functions.

Function key	Description	Function key	Description
	Opens a table where you can set the maximum and minimum alarm limits.		This is an alarm mode key to change Normal/ Audio Paused/ Alarm Paused mode.

	Registration of affiliation/discharge information.		Displays the setup menu.
	Enable waveform freeze function.		Displays the automatic blood pressure measurement interval setting menu.
	Displays the printer setup menu.		Displays trend menu.
	Displays the mini Trend window.		Set parameters in text screen.

2. Setup

Overview

This chapter describes how to configure your monitor

Monitor Configuration

Main Menu tree

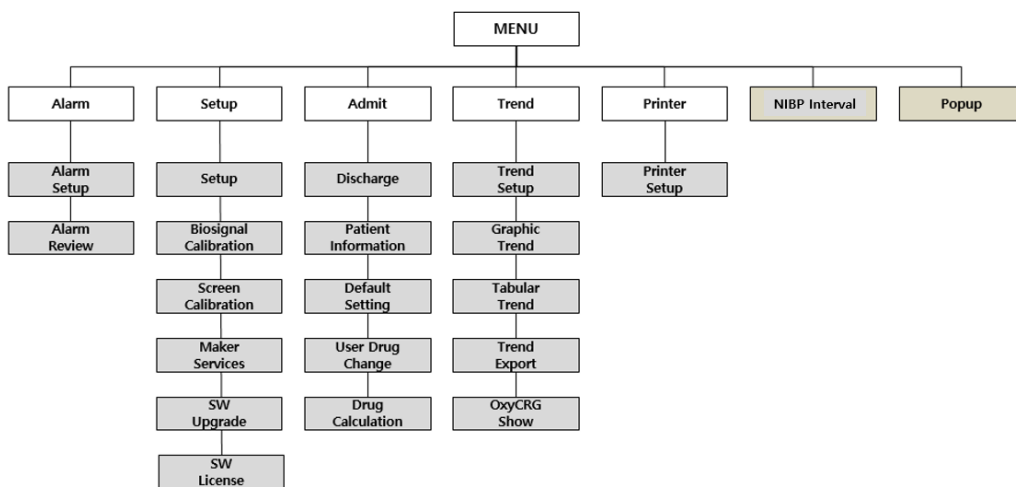

Parameter menu tree

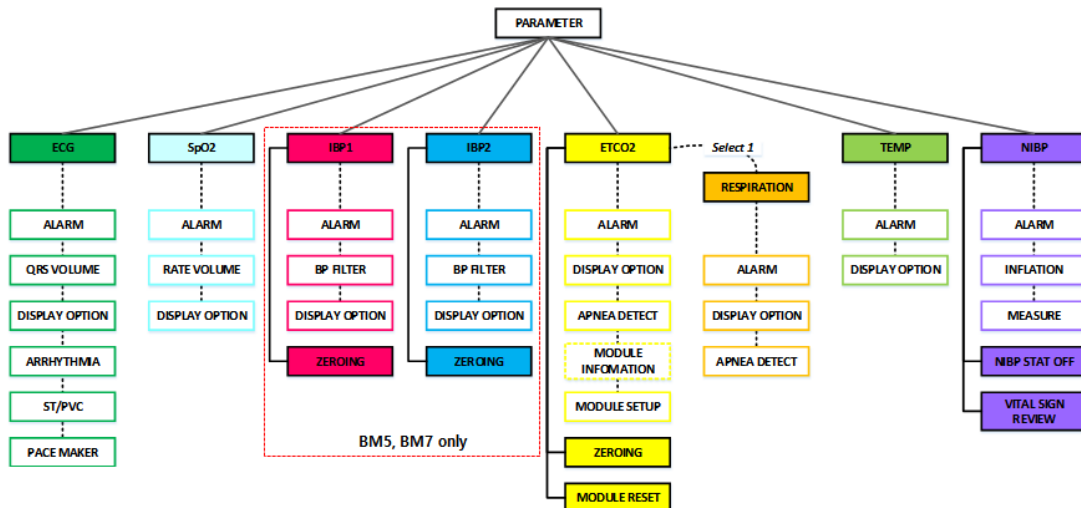

Main Menu Setup

The Setup menu allows the user to access submenus, display screens, and perform specific monitor

setup functions.

1. To display the Settings menu, click the Settings icon  to open the submenu.
2. Click the desired setting to access the submenu that performs the desired function or go one step further down.
3. Click Close at the bottom of the submenu list to return to the previous menu or screen.

	Main menu	Sub menu
	A. Setup	A-1. Parameter setup
		A-2. Parameter units
		A-3. User services
		A-4. System information
		A-5. Network information
		A-6. Central
		A-7. HL7
		A-8. Alarm setup
		A-9. Display option
		A-10. Hospital information
	B. Biosignal calibration	B-1. ECG & RESP
		B-2. NIBP
		B-3. IBP
	C. Screen calibration	
	D. Maker service	D-1. MAC address
		D-2. Factory reset
		D-3. System information(Emmc)
	E. SW upgrade	
	F. SW license	

Menu	Description	Available settings
A. Setup menu		
A-1. Parameter setup	Measurement on the monitor parameter selection and color setting menu: ECG, SPO2, RESP, NIBP, TEMP, ETCO2, IBP1 ¹⁾ , IBP2 ¹⁾	Parameter enable ON/OFF Parameter color setup

A-2. Parameter units s	Unit setting menu used for monitor measurements	
A-2-1. Weight unit	Weight measurement unit	Kg Lbs
A-2-2. Height unit	Height measurement unit	Cm Inch
A-2-3. Blood pressure unit	Blood pressure measurement unit	mmHg kPa
A-2-4. ST unit	ST measurement unit	mm mV
A-2-5. Temperature unit	Temperature measurement unit	°C °F
A-2-6. Gas pressure unit	Gas measurement unit	mmHg kPa vol%
A-3. User service	User configuration menu	
A-3-1. Hospital unit	Set Monitor Environment Group	OR RECOVERY USER DEFINE
A-3-2. Bed #	Set device number	1~300
A-3-3. Key sound	Set key activation	On / Off
A-3-4. Key volume	Set key sound	Off ~ 100%
A-3-5. AC filter	Power filter settings	Off, 50Hz, 60Hz
A-3-6. Screen brightness	Set screen brightness	10~100%
A-3-7. Date display	Set type of date display	On / Off
A-3-8. Demo	Set demo	On / Off
A-4. System information		
A-4-1. S/W version	Display main S/W version	
A-4-2. NIBP version	Display NIBP module F/W version	
A-4-3. License	Display device license	
A-4-4. Language	Set language	English, Korean French, Bulgarian Polish, German Chinese, Portuguese Hungarian, Czech Romanian, Italian Turkish, Spanish Russian, Greek

		Japanese
A-5. Network information	Network information and setup	
A-5-1. Wireless	Wifi setup	On / Off
A-5-2. DHCP	Auto IP allocation setting menu	On / Off
A-5-3. Device IP	IP setting menu	XXX.XXX.XXX.XXX
A-5-4. Subnet mask	Subnet mask setting menu	XXX.XXX.XXX.XXX
A-5-5. Gateway IP	Gateway setting menu	XXX.XXX.XXX.XXX
A-5-6. Network interface	Network interface information	
A-6. Central	Central network menu	
A-6-1. Protocol version	Network protocol menu	X.XX
A-6-2. Central comm	Remote communication menu	On / Off
A-6-3. Central IP	Remote PC IP address setting	XXX.XXX.XXX.XXX
A-7. HL7	HL7 network message settings	
A-7-1. HL7 COM	Communication version	
A-7-2. HL7 IP	Remote PC IP address setup	XXX.XXX.XXX.XXX
A-7-3. Port	Remote PC port address	XXXX
A-7-4. HL7 Period	Transmission cycle settings menu	10sec, 30sec, 1,3,5,10,15,30min, 1 hour, 6 hours
A-7-5. HL7 NAK	NAK transmission menu setup	On / Off
A-7-6. Editr HL7 label	Parameter label edit menu	
A-8. Alarm setup	Alarm settings menu	
A-8-1. Alarm password	Alarm setup password activation menu	On / Off
A-8-2. Setup password	Password setup menu	
A-8-3. Alarm sound	Alarm sound type selection menu	IEC60601 BIONET
A-9. Display option		
A-9-1. Sweep speed (ECG/SPO2/RESP)		6.25 mm/sec, 12.5 mm/sec 25 mm/sec (Default), 50 mm/sec
A-9-2. Sweep speed (RESP/ETCO2)		6.25 mm/sec, 12.5 mm/sec (Default), 25 mm/sec
A-10. Hospital information	Set Hospital information	
A-10-1. Hospital name	Hospital name	
A-10-2. Address 1	Address information 1	

A-10-3. Address 2	Address information 2	
A-10-4. Postal code	Set postal Code	
A-10-5. Doctor name	Doctor name	
B. Biosignal calibration		
B-1. ECG & RESP		
B-1-1. ECG calibration	ECG calibration menu	10mm/mV input calibration display
B-1-2. RESP calibration	RESP calibration menu	1ohm /1mm display
B-2. NIBP		
B-2-1. Zero calibration	NIBP zero calibration menu	Zero calibration menu at atmospheric pressure
B-2-2. Gain calibration	NIBP gain control menu	Perform 250mmHg pressure calibration and select menu
B-2-3. Pneumatic pump	NIBP pump control menu	On / Off
B-2-4. Pneumatic valve	NIBP valve control menu	Close /Open
B-3. IBP¹⁾		
B-3-1. IBP1 calibration ¹⁾		Perform 100mmHg pressure calibration and select menu
B-3-2. IBP2 calibration ¹⁾		Perform 100mmHg pressure calibration and select menu
C. Screen calibration		
Perform touch screen calibration point input		
D. Maker services		
D-1. MAC address editing		Enter a unique address for the device
D-2. Factory reset	Reset menu for setting the device to factory default state	Perform factory reset
D-3. System information(Emmc)	View emmc information	
E. SW upgrade		
Software Upgrade menu		
F. SW license		
Software License menu		

¹⁾: BM5Vet Elite, BM7Vet Elite only

Parameter color

Selectable colors			
green, light blue, magenta, yellow, blue, sky blue, white, coral, scarlet, purple, orange, pale green, pink, pale yellow			
Parameter	Default color	Parameter	Default color
ECG (ST)	Green	SpO2	Light Blue
RESP	Yellow	NIBP	Magenta
TEMP	Green	ETCO2	Yellow
IBP1 ¹⁾	Scarlet	IBP2 ¹⁾	Light Blue

¹⁾: BM5Vet Elite, BM7Vet Elite only

3. Network

Overview

When you connect the monitor to the network, you can access animal information from another monitor or central station connected to the network. These devices provide main screen information for remote viewing from each other.

BT-Link connects the monitors to the central station and each device to provide various monitoring functions. The User Monitor's Bed-to-Bed Viewing feature allows the user to view other monitor screens connected to the network and to silence remote control and alarms [Audio Paused].

With the Remote Control feature in BT-Link, you can perform the following tasks on a Veterinary Multiparameter Monitor that can be remotely controlled from a central station.

- Start recording
- Modify alarm limit
- Alarm Mute
- Print the current monitor screen to a network laser printer (Using the optional remote keypad)
- Enter, edit, and view animal data

Network Connection

In a network, data can be exchanged over wired or wireless technology. All data interfaces (e.g., RS-

232, LAN, USB interface) described in the standard and convention can be network. This device can exchange information with other devices through the network during operation and supports the following functions.

- Display waveform and parameter data
- Alarm signal
- Remote control (e.g., alarm management)
- Device setup and transmission of animal data

Connecting this device to an integrated network with other devices, or subsequent changes to that network, can be a new risk to animals, users, and third parties. These risks must be identified, analyzed, and evaluated before the device is connected to the network or the network is changed, and appropriate action must be taken.

Subsequent changes to the network example:

- Network configuration change
- Removing a device from the network
- Adding new devices to the network
- Upgrading or updating devices connected to the network

Warning	<p>Recommendations for wireless connections</p> <ul style="list-style-type: none"> ● BM3Vet Elite, BM5Vet Elite, BM7Vet Elite monitors have a change in the number of equipment connections depending on wireless AP (Access Point) performance. ● When using a general AP, it is recommended to connect no more than 8 units to the same network. ● Due to the nature of wireless, connectivity may not be good depending on the environment
----------------	--

Note	<p>Supported USB Wi-Fi Dongle</p> <p>This patient monitor supports the following dongles of USB VID and PID.</p> <table border="1" style="margin-left: auto; margin-right: auto;"> <thead> <tr> <th style="background-color: #d9d9d9;">USB VID:PID</th> </tr> </thead> <tbody> <tr> <td style="text-align: center;">2357:0120</td> </tr> <tr> <td style="text-align: center;">2357:011e, 2357:0122</td> </tr> </tbody> </table>	USB VID:PID	2357:0120	2357:011e, 2357:0122
USB VID:PID				
2357:0120				
2357:011e, 2357:0122				

2357:011f
0bda:0811, 0bda:0821, 0bda:8822, 0bda:a811
2357:010d
148f:761a
0e8d:7650
148f:7601
0bda:8176

This patient monitor has tested the following USB Wi-Fi dongles.

TP-Link

Model	USB VID:PID	chipset
TP-LINK T2U plus	2357:0120	Realtek 8821a
TP-LINK T2U nano	2357:011e, 2357:0122	Realtek 8821a
TP-LINK T2U v3	2357:011f	Realtek 8821a
Other 8821A models	0bda:0811, 0bda:0821, 0bda:8822, 0bda:a811	Realtek 8821a
TP-LINK T2UHP	2357:010b	MediaTek 7650u
TP-LINK T2U	148f:761a	Ralink 7610u
TP-LINK T2UH	148f:761a	Ralink 7610u
TP-LINK T2U v2	0e8d:7650	MediaTek 7650u

ipTime

Model	USB VID:PID	chipset
Other 7650u / 7610u models such as ipTime A1000	148f:7610, 0e8d:7610	MediaTek 7650u / 7610u
ipTime N150UA TP-Link TL-WN727N v4	148f:7601	Ralink 7601U

	ipTime N150UA / N150U	148f:3070	Realtek 3070
	ipTime N150UA	148f:5370	Realtek 5370
	ipTime N100mini (N300U / Ncubic)	0bda:8176	Realtek 8188CU/8192CU
	TP-Link TL725N v2	0bda:8179	Realtek 8188EUS

Even if the USB VID and PID dongles are listed above, dongles that have not been tested by the company may not be supported.

Caution	<p>It may take up to 5 seconds for the Wi-Fi dongle to connect to the patient monitor and be recognized.</p> <p>At this time, be careful as the USB may not work when the Wi-Fi dongle is removed.</p>
----------------	--

Note	<p>BT-Link Software version compatibility Information</p> <p>BM3Vet Elite / BM5Vet Elite / BM7Vet Elite Veterinary Multiparameter Monitors is available from BT-Link v2.4.01 or later.</p>
-------------	--

IT Network Connection

No one other than service personnel can connect this device to your network. Please consult with the hospital IT staff in advance. Please refer to the following documents to proceed with the installation.

- Documents attached to this unit
- Network Interface Manual
- BM Vet central monitoring system (BT-Link, B-Link) user documentation

We recommend that you follow IEC 80001-1 (Hazard Management of IT Networks Connected with Medical Devices).

LAN Network

LAN networks are usually configured through a star topology. Individual devices can be combined into groups via a layer-n-switch. Other data traffic is separated by separate VLAN networks. Configure the device's network settings according to this user manual and network specifications.

LAN connection specifications are described in the following standard specifications.

- Wired Network: IEEE 802.3
- Wireless network: IEEE 802.11 (a, b, g, n)

If the device is to be used as a layer-2-switch or layer-3-switch, the port setting must be configured on the network switch. Bionet equipment must be configured to make the network settings compatible with the specifications of the operating organization.

This device exchanges data with other medical devices over a LAN network. The network supports the following transports and protocols:

- TCP / IP
- Broadcast

VLAN Network

If data is exchanged within a single network, an independent VLAN network for the clinical information system must be established. At least one of the following independent VLAN networks must be established.

- Network for medical devices in hospital
- Network for portable Veterinary Multiparameter Monitors

In addition, a network system that detects and defends against denial-of-service attacks must be established through the installation of equipment dedicated to DDos defense.

Inappropriate Network

If your network does not meet the requirements, the following dangerous situations can occur.

If the distributed alarm system is not safe:

- The alarm will not be delivered.
- The alarm or data is delayed.
- An error alarm appears

If the network connection is interrupted:

- The alarm will not be delivered.
- Reactivates with the alarm off or the alarm sound off

If you do not have firewall and antivirus software:

- Your data is not protected.
- The device settings could be changed
- The device raises an error alarm or does not generate an alarm.
- Data is sent incomplete, to the wrong device, or not at all.
- Animal patient data is blocked, falsified, or corrupted.
- The time stamp of the data is inaccurate

Overloading this unit due to very high network loading (e.g. denial of service attacks) can cause interface deactivation. The interface can only be used again after the device is restarted. Rarely, booting may be slow or repeated reboots may occur

Bed-to-Bed Viewing

If the monitor is connected to a network, you can view other monitors connected to the network on your monitor and make the alarm silent. The procedure for displaying the remote view screen is as follows. To set the menu display time, refer to the setting page below.

Note

The Print Screen Sticky key on the front panel of the monitor allows you to print the remote view screen as it appears on your local monitor.

The menu below is a setup menu for retrieving data from other veterinary multiparameter monitoring devices connected to the same network. To view the menu settings, touch the My BED number box in the top menu bar.



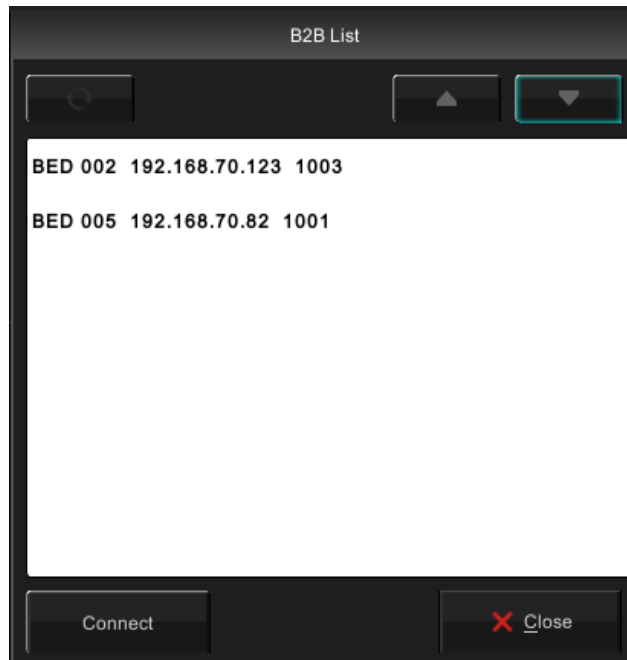

Bed-to-Bed Viewing monitor list submenu

Menu	Description	Available settings
Bed-to-Bed Viewing monitor list sub menu		
Refresh	Menu to update monitor list connected to network	
Up	Move to upper list	
Down	Move to lower list	
Monitor list	List of compatible monitors connected to the network	
Connect	Monitor connection menu for remote connection	

Display Mode

Wave and numeric mode

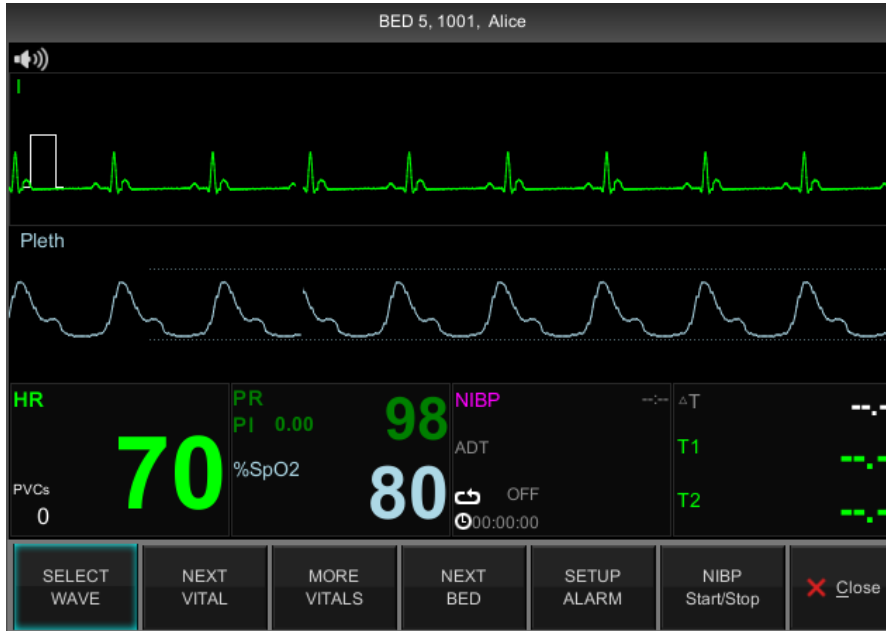

Numeric Mode

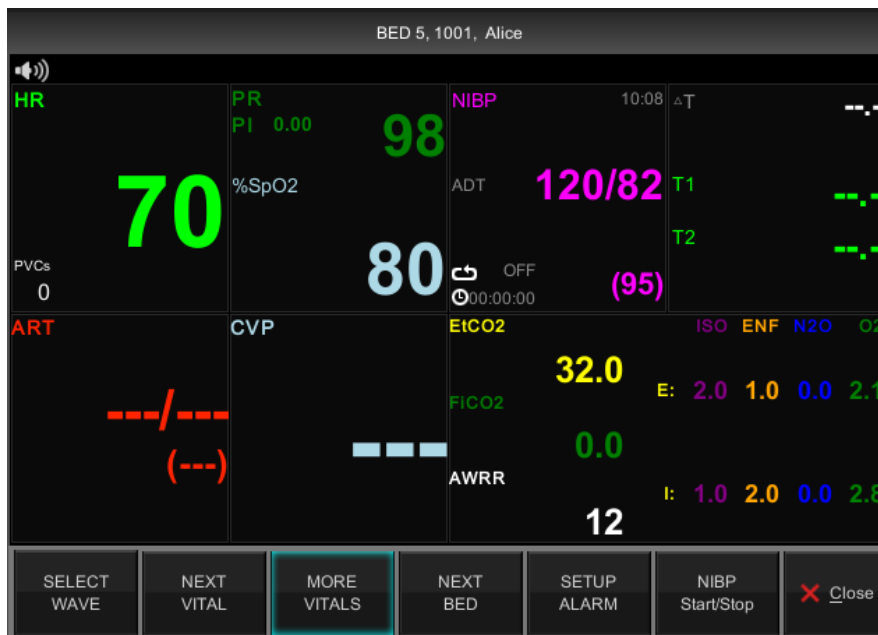

Menu	Description	Available settings
A-1. Select wave	Waveform selection menu to view	
A-1-1. Trace I	The waveform selection menu for	ECG, SpO2, RESP, EtCO2,

	Trace I in the Bed-to-Bed Viewing window	IBP1 ¹⁾ , IBP2 ¹⁾
A-1-2. Trace II	The waveform selection menu for Trace II in the Bed-to-Bed Viewing window	ECG, SpO2, RESP, EtCO2, IBP1 ¹⁾ , IBP2 ¹⁾)
A-2. Next vital	Additional parameter selection menu	
A-3. More vitals	Wave screen and text screen selection menu	
A-4. Next bed	Connect to the following connected monitor devices	
A-5. Setup alarm	Alarm setting menu of remotely connected monitor	Normal Audio paused Alarm paused Audio off Alarm off
A-6. NIBP Start/Stop	NIBP measurement start and stop menu	Start Stop
A-7. Close	Remote viewer close menu	

¹⁾ : BM5Vet Elite, BM7Vet Elite only

4. Admission and Discharge

Overview



The animal patient admit menu allows you to enter and edit an individual animal information (ID, Animal and Guardian Name, Animal Type, Gender, Weight). If your monitor is operating in a network monitoring, you can also review or change the monitor's care unit and bed label assignments.

Animal data and trends can also be transferred to PC. The transfer procedure depends on whether the Inbound and Outbound monitors are connected to the Central network.

Animal Admission

How to admit an animal:



1. Press the **animal icon** button.
2. Click on **Admit**.
3. Click on **Animal information**.
4. Please select a blank field. The data entry screen appears.
5. Click the letter of the word you want to input.
6. If you made a mistake, click Backspace  and try again.
7. Click **Enter**  to confirm your entry.
8. Click on the next field and repeat steps 5 and 6.

Note

To change an animal's classification (Dog, Puppy, Horse, or Cat), access the animal settings menu.

Animal Discharge





The animal should be discharged before another animal is admitted. Otherwise, the monitor attaches the existing data to the animal.

How to discharge an animal:



1. Press the **Animal icon** button.
2. Press the **Discharge menu**.
3. You can see Discharge confirm message.
4. Press the **Accept button**. The discharge procedure is in progress. The monitor displays a Discharge message. When the animal is successfully discharged, a banner with the following message is displayed.

Animal type: When you set the animal type, type image is displayed on the upper left corner.

Type	Admit	Discharge
PUPPY		
CAT		
DOG		
HORSE		

	Main menu	Sub menu
	A. <u>A</u> dmit / <u>D</u> ischarge	
	B. Animal information	B-1. Animal information
	C. Default setting	

B. Animal Information menu		
Sub menu	Description	Available settings
B. Animal information		
B-1. Animal Information		
B-1-1. Animal type	Animal type setting	Dog / Puppy / Horse / Cat
B-1-2. ID	Animal ID setting	
B-1-3. Auto ID	Auto ID generation	

B-1-4. Pet Name	Animal name	
B-1-5. Client/Owner	Guardian name	
B-1-6. Gender	Gender setup	Male, Female
B-1-7. Weight	Weight setting	XXX.XX Kg (Lbs)
C. Default Setting menu	Default steeting animal information	

Registration of Animal ID using barcode

This product can input the ANIMAL ID in barcode format to the device using USB barcode scanner. First, connect the barcode scanner to the USB HOST connector on the left as shown in the figure below. After the BEEP sound is generated, the barcode icon () appears at the bottom of the screen.

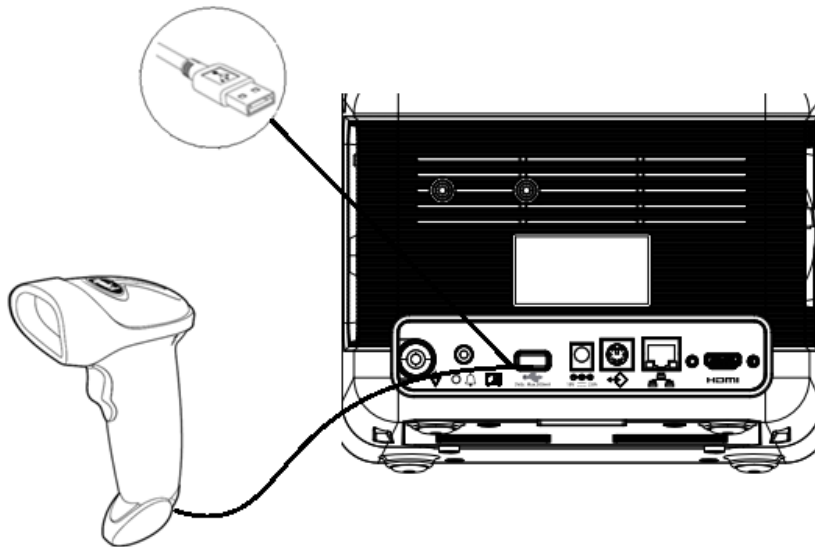

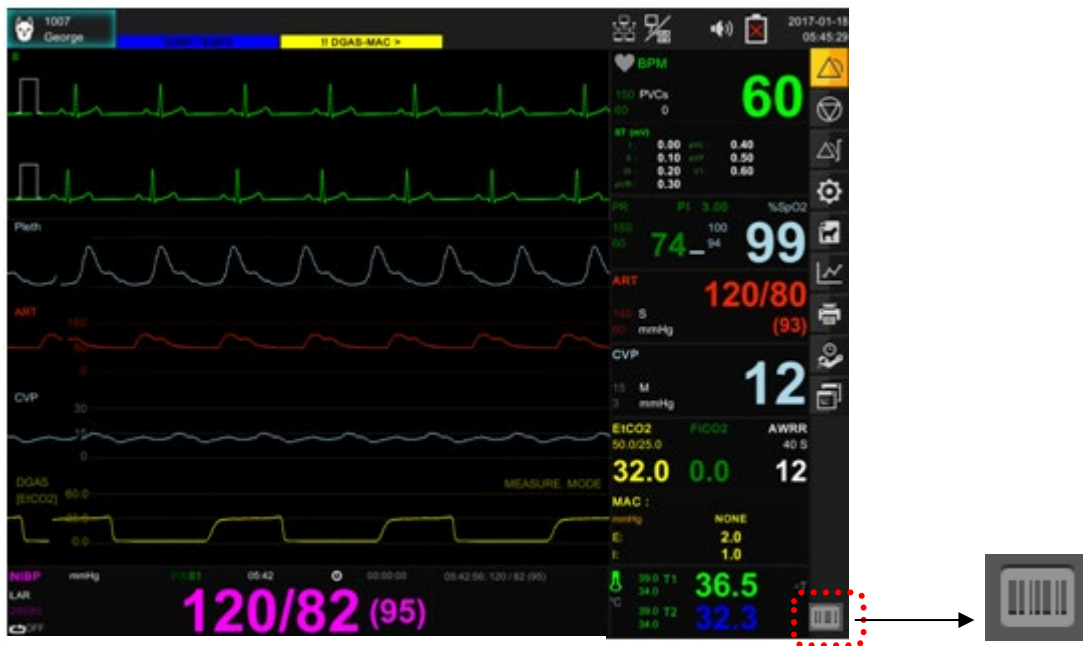

BM7Vet Elite Image is shown as an example

The barcode that you want to input is matched to the index LED generated by the scanner, and if you press the input button, the corresponding ID is read and sent to the equipment. The sender ID is displayed at the top center of the screen.

5. Alarm

Overview

The monitor displays the alarm limits (parameter threshold) and can be configured by the user to raise an alarm if exceeded. Limits are displayed both in the alarm limits table and in the parameter box. If this limit is exceeded, a visual and/or audible alarm will occur.

The bedside monitor is the primary alarm device, and there may be other secondary alarm devices depending on how you configured the device / network. Depending on the alarm condition, the monitor generates an alarm using one or more of the following devices:

- sound reflecting alarm severity
- Change the color in the parameter box of the alarm parameter
- Alarm messages in the local message area
- Alarm banner indicating alarm status
- External alarm device such as nurse call system
- Activate alarm recording



The monitor generates an alarm when the parameter in the Alarm Limits table is **ON**. It is not a prerequisite that the parameter is displayed on the display or connected in the event of an alarm.







Alarm Priority

The alarm type is divided into an animal status alarm and a product status alarm.



The animal status alarm sounds when the diagnostic function (ECG 13 auto diagnosis) and alarm upper and lower limits are exceeded, and there are levels of High, Medium, Low and Message, and there is a difference in the order and volume of the alarm. You can set the alarm level for each parameter and function. The animal status alarm provides the highest priority alarm.

The features of each alarm are described as follows. The alarm priority is High > Medium > Low > Message. For high or medium alarms, the printer output is supported when 'Alarm print on' is set.

Alarm priority	Alarm sound	Numeric window	Alarm printer	Alarm lamp
High		RED 1time every		

		2sec blinking		2times every 1sec blinking
Medium		YELLOW 1time every 2sec blinking		 1time every 2sec blinking
Low		YELLOW 1time every 2sec blinking		 Non blinking
Message		BLUE Non blinking		

Product status alarm -It is labeled as 'Technical Alarm' in the instrument.

Alarm priority	Alarm sound	Numeric window	Alarm printer	Alarm lamp
Low		BLUE 1time every 2sec blinking		 No blinking
Message		BLUE 1time every 2sec blinking		



: Alarm sounds



: Waves are printed out



: Red color alarm indicator on the screen



: Yellow color alarm indicator on the screen



: Blue color alarm indicator on the screen



: Red color alarm lamp



: Yellow color alarm lamp



: Cyan color alarm lamp

Audible alarm		
Alarm priority	BIONET	IEC
High	1 high tone every 5 seconds	10 consecutive beeps every 5 seconds
Medium	1 high tone every 15 seconds	3 consecutive beeps every 15 seconds
Low	1 low tone every 30 seconds	2 consecutive beeps every 30 seconds

Note

The maximum latent value of the audible alarm is less than 10 seconds after the alarm delay time.

The alarm delay time of the distributed alarm system is within 2 seconds.

Alarm Management

You can use the lock key on the front of the monitor to hold the alarms.

To change Alarm Mode: A short press of the alarm control key circulates through the Normal / Audio_Paused / Alarm_Paused alarm modes. Press and hold the key for more than 3 seconds to switch to Alarm_Off / Audio_Off mode using the mode selection dialog regardless of which alarm mode the monitor is currently in.

Audio_Paused: Stop the audible alarm for 1 minute but the visual alarm is activated still. Banner with the message Audio Paused and countdown timer are displayed on the screen. After the user switches to another alarm mode or after the timeout period has elapsed if the alarm occurs still, visual, and audible alarms will be activated again.

Alarm_Paused: Stop visual and audible alarms during user defined time. Banner with the message Alarm Paused and countdown timer are displayed on the screen. After the user switches to another

alarm mode or after the timeout period has elapsed if the alarm occurs still, visual, and audible alarms will be activated again.

Alarm_Off: Stop visual and audible alarms. A banner with the message Alarm Off is displayed on the screen. The monitor maintains Alarm Off mode until user switch to another alarm mode.

Audio_Off: Stop the audible alarm. A banner with the message Audio Off is displayed on the screen. The monitor maintains Audio Off mode until user switch to another alarm mode

Nurse call

If the monitor is sounding an alarm, the nurse call system is signaling.

When an audible alarm is silenced (Audio Pause or Audio Off) at the bedside unit, the nurse call system will not alarm.

Your system administrator can change the alarm priority level for the nurse call signal.

If the priority level is set to **High**, only high-priority alarms will sound on the nurse call system.

Note	<p>Audio Paused and Audio Off modes only stop the audible alarm sound and touch or key sound is activated always.</p> <p>To adjust the Touch or Key Sound, use the Key Sound menu in Setup.</p>
-------------	---

Alarm Settings

	Main menu	Sub menu
	A. Alarm setup	A-1. Parameter alarm limit
		A-2. Arrhythmia alarm condition
		A-3. System alarm condition
		A-4. Alarm parameter
		A-5. Nurse call
	B. Alarm review	

Sub menu	Description	Available settings
A. Alarm setup menu		
A-1. Parameter alarm limit	All parameter alarm, level, activate Setup menu	
A-2. Arrhythmia alarm	Arrhythmia alarm level, action setting	

condition	menu ASYSTOL, VTAC, VTAC /VFIB, BIGEMINY ¹⁾ , TRIGEMINY ¹⁾ , ACCVENT ¹⁾ , COUPLET ¹⁾ , IRREGULAR ¹⁾ , PAUSE ¹⁾ , RONT ¹⁾ , VBRADY ¹⁾ , SHORTRUN ¹⁾ , PVC ¹⁾	
A-3. System alarm condition	Low battery	
A-4. Alarm parameter	Alarm settings menu	
A-4-1. Alarm volume	The volume can be changed from OFF to 10% to 100%.	Off, 10~ 100%
A-4-2. Alarm pause time	No sound for 5minutes, Release on alarm again	1,2,3,5,10,15min
A-5. Nurse call	User Settings menu.	
A-5-1. Nurse call on alarm	NURSE CALL setup menu	On / Off
A-5-2. Call type	Nurse call type setup menu	Normal open Normal close
A-5-3. Duration	Nurse call duration setup menu	One time Continue Cycling
A-5-4. Level	Alarm level setup	Low Medium High

¹⁾ : BM5Vet Elite, BM7Vet Elite only

Alarm Event(Physiological Alarm Review)

1	IBP-M	LOW	2017-02-23 12:13:30	IBP2 - MEAN Value
2	IBP-M	LOW	2017-02-23 12:13:27	IBP2 - MEAN Value
3	IBP-M	LOW	2017-02-23 12:13:24	IBP2 - MEAN Value
4	IBP-M	LOW	2017-02-23 12:13:21	IBP2 - MEAN Value
5	IBP-M	LOW	2017-02-23 12:12:48	IBP2 - MEAN Value
6	IBP-M	LOW	2017-02-23 12:11:42	IBP2 - MEAN Value
7	M/DGAS-ETCO2	LOW	2017-02-23 12:11:40	MGAS - ETCO2 Value
8	IBP-M	LOW	2017-02-23 12:11:39	IBP2 - MEAN Value
9	IBP-M	LOW	2017-02-23 12:11:36	IBP2 - MEAN Value
10	IBP-M	LOW	2017-02-23 12:11:33	IBP2 - MEAN Value

BM7Vet Elite image is shown as an example

6. Trend

Overview

The monitor stores trend data for all connected signals. Users can request trend recording and can also print the screen of trends displayed.

Triggered alarm events are displayed in red inverted triangles on the Event List and Timeline

Trend Setting

	Main menu	Sub menu
	A. Trend Setup	A-1. Popup Trend
	B. Graphic Trend	B-1. Graphic Trend
		B-2. Tabular Trend
	C. Tabular Trend	C-1. Graphic Trend
		C-2. Tabular Trend
D. Trend Export		
E. ECG Waveforms Review		

Sub menu	Description	Available settings
A. Trend setup menu		
A-1. Popup trend		
A-1-1. Time period	Show time interval setting menu	30min, 60min, 90min, 3hour, 6hour
A-1-2. Configure parameters	Configure the bio signal to be shown in the popup trend window	
B. Graphic trend menu		
B-1. Graphic trend		
B-1-1. Event list	Selectable alarm list is displayed	
B-1-2. Time period	Set the time and see the stored values at each set time.	30min, 60min, 90min, 2hour, 3hour, 4hour, 6hour, 8hour, 12hour
B-1-3. Display group	Configure the bio signal to be shown in the graphic trend window	
B-1-4. Print	Graphic trend print output	

C. Tabular trend menu		
C-1. Tabular trend		
C-1-1. Event list	Selectable alarm list is displayed	
C-1-2. Time period	Time period setting	1min, 5min, 10min, 15min, 30min, 1hour, 2hour
C-1-3. Display group	Configure the bio signal to be shown in the Tabular trend window	
C-1-4. Print	Tabular trend print output	
D. Trend Export menu		
D-1. Start time	Parameter save start time setting menu	
D-2. End time	Parameter save last time setting menu	
D-3. Export time period	Time period setting	1min, 5min, 10min, 15min, 30min, 1hour
D-4. Export order	Sequence of parameters	Descending Ascending
D-5. Export	Save data to USB memory	
E. ECG Waveforms Review menu		
E-1. Lead	Select lead to display on screen	I, II, III, AVR, AVL, AVF, V
E-2. Duration	The time interval you want to see during the entire time	1/2/3/4/5 min
E-3. Detail View	Show the detail view corresponding to the detail time interval	

Graphical Trend

Trend graph shows saved trend data as individual graph type for each parameter. These graphs show that the displayed parameters are active over a significant period of time and can display up to five channels at a time. Confirmation color, scale meter labels and numbers are displayed on the left side of the trend channel. The vertical lines in each graph displays the time distribution. Trend Review keeps the most up-to-date data, which is automatically updated on the right side of the graph.

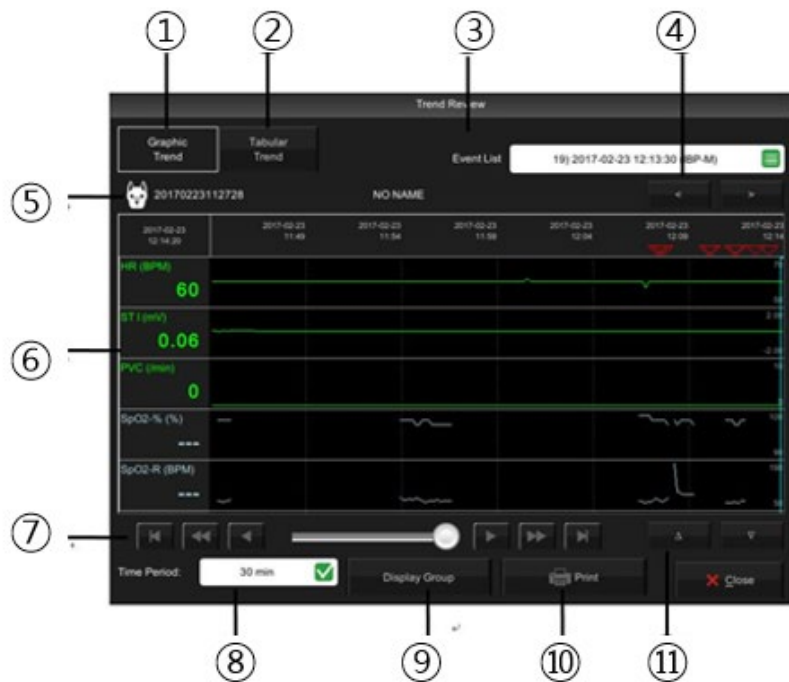

- ① Graphic trend select menu
- ② Tabular trend select menu
- ③ Event list menu
- ④ Event previous/next menu
- ⑤ Animal ID
- ⑥ Numeric parameter window
- ⑦ Selection Navigation window
- ⑧ Trend interval setting menu
- ⑨ Parameter selection slider
- ⑩ Printer menu
- ⑪ Parameter window selection menu

Tabular Trend

The Trends table displays the trend data in an easy-to-read table format. Up to six are displayed, updated every minute. The time stamp above each column indicates the interval at which the data in that column was trended. The value displayed is the last one acquired during the interval, and the most recent data is displayed in the rightmost column.



- ① Graphic Trend select menu
- ② Tabular Trend select menu
- ③ Event list menu
- ④ Event previous/next menu
- ⑤ Animal ID
- ⑥ Numeric Parameter window
- ⑦ Selection Navigation window
- ⑧ Trend interval setting menu
- ⑨ Parameter selection slider
- ⑩ Printer menu
- ⑪ Parameter window selection menu

File Export

The file extract function can transfer trends to a file using USB memory.

1. Confirm USB memory connection.
2. Press TREND > Trend Export button.
3. Set a start time, end time, export time period, and export order.
4. Press Export button
5. The data is transferred to USB memory. A completion message is displayed when the transmission is completed.

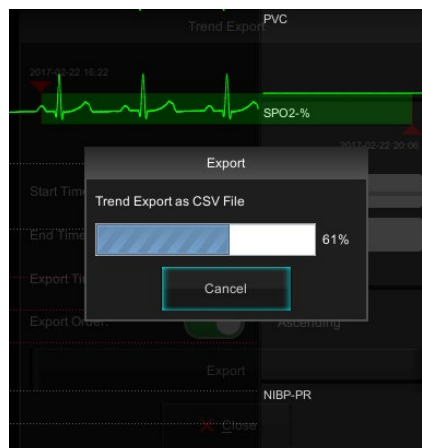
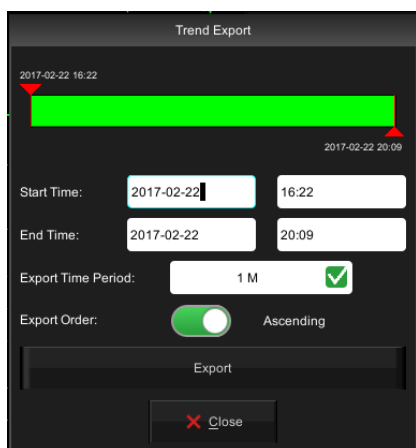

Warning

BM3Vet Elite / BM5Vet Elite / BM7Vet Elite Veterinary Multiparameter Monitors is compatible with external USB memory drives up to 64GB. We recommend products by the following brands: San Disk, PNY, Transcend, Samsung.

When using a product with high power consumption, such as an external hard drive, be sure to use the provided adapter for suitable power supply. (Unit cannot be used alone as a power supply).

High power devices may not be supported.

<p>Note</p>	<p>Saving Animal Data to a USB</p> <p>Exported animal data on a USB memory drive is not encrypted and therefore raises privacy concerns. So, only authorized personnel should be allowed to view, handle, store or transmit animal data.</p> <p>The file format of the USB memory drive used for the BM3Vet Elite, BM5Vet Elite, BM7Vet Elite is FAT32.</p>
--------------------	--

Popup Tend

The user can continue to monitor the main screen waveform and parameter box while displaying trend data for up to 7 parameters for up to 6 hours. The pop-up trend graph follows the display order indicated by each parameter in the trend setup and is updated with new trend data every 60seconds. When selecting pop-up trend, you can switch to ST analysis window and double-zoom mode.

If there is no parameter set in Trend setup> Configure parameters, only ST analysis window is displayed.

To change the popup menu window, touch the top and bottom of the popup menu with the touch key, or select it with the rotary switch.

Popup trend window

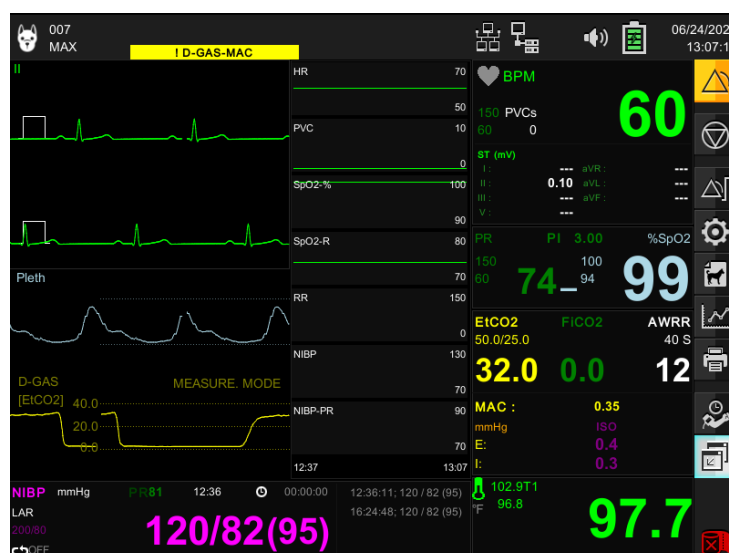

BM3Vet Elite

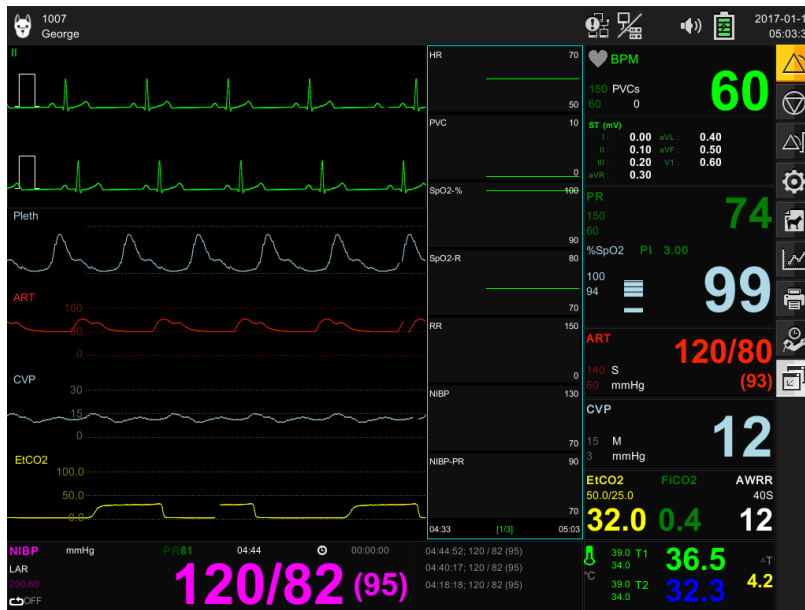

BM5/7Vet Elite

Pop-up ST Window

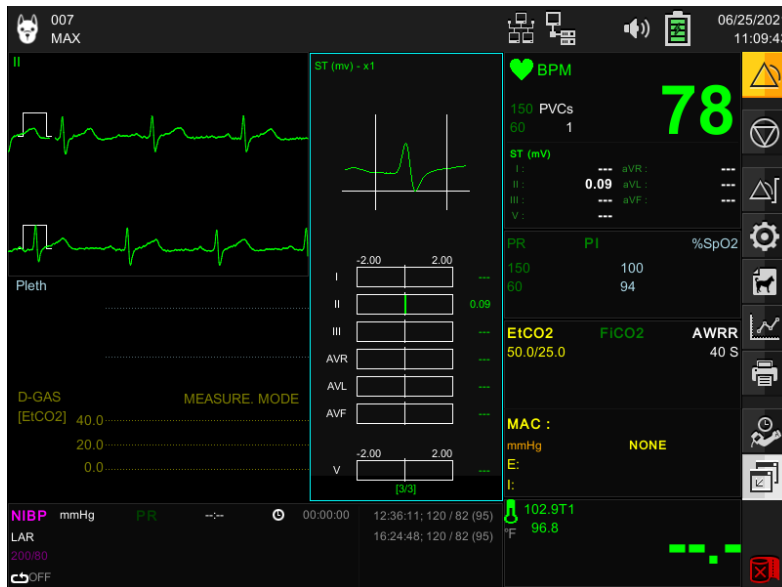

BM3Vet Elite

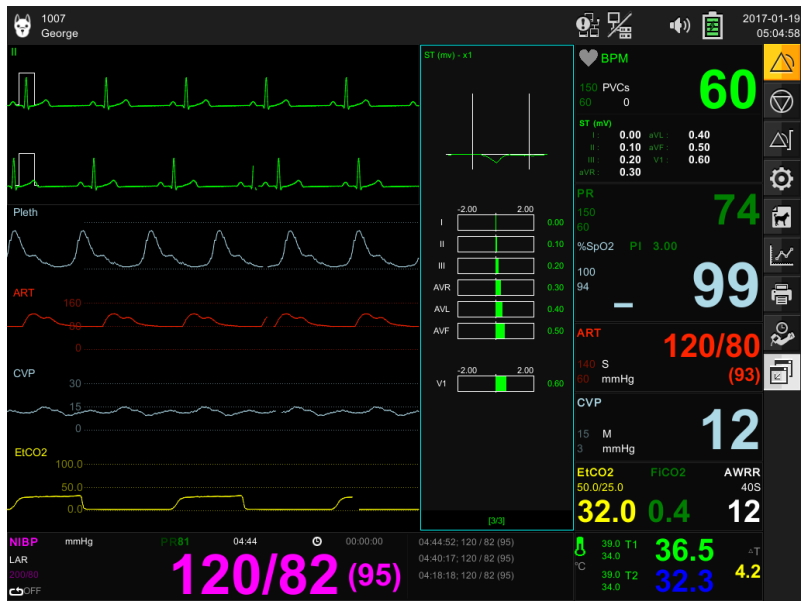

BM5/7Vet Elite

Pop-up Enlarge Trend Window

You can change the size of the popup menu by pressing and releasing the center of the popup menu for at least 1 second.

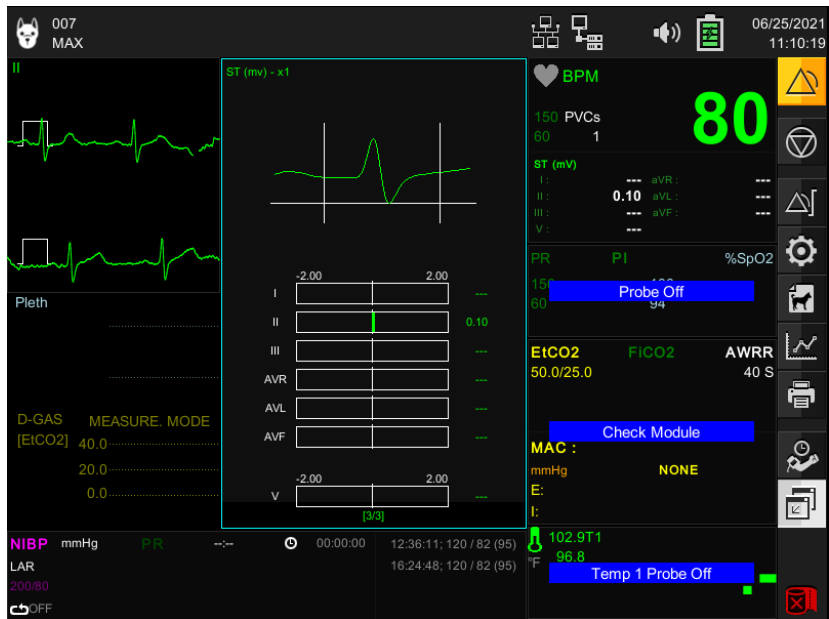

BM3Vet Elite

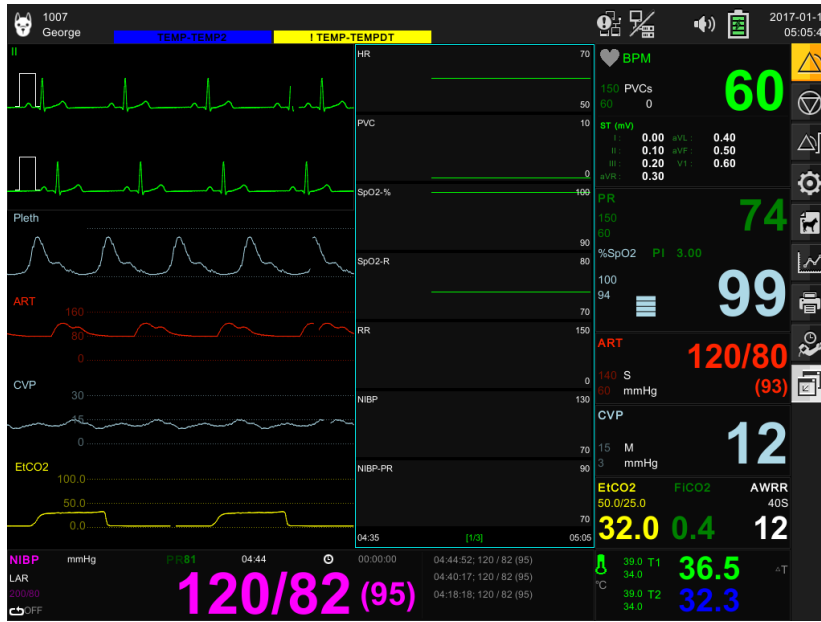

BM5/7Vet Elite

7. ECG

Overview

The monitor can calculate heart rate, detect arrhythmia, and display ECG data. The electrocardiogram screen provides 1 channel, 2 channel, and 7 channel displays. It calculates the heart rate by detecting the electrocardiogram signal of the animal and alarms according to the set upper and lower limit of alarm.

ECG connector position and measurement cable

BM3Vet Elite

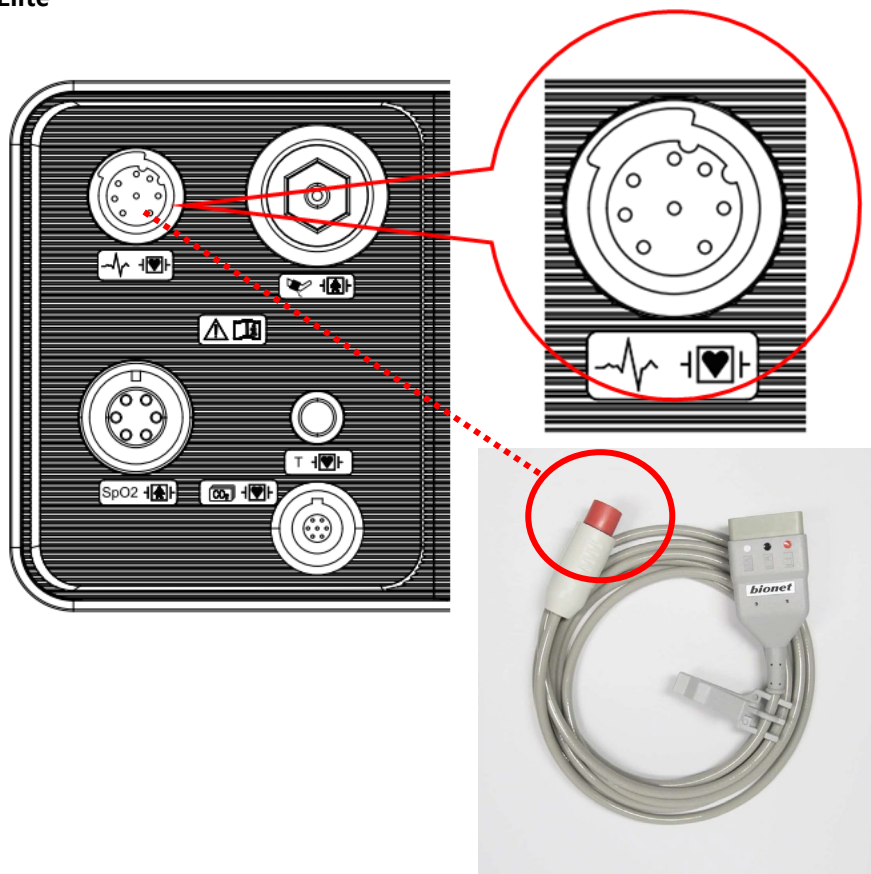

BM5Vet Elite/BM7Vet Elite

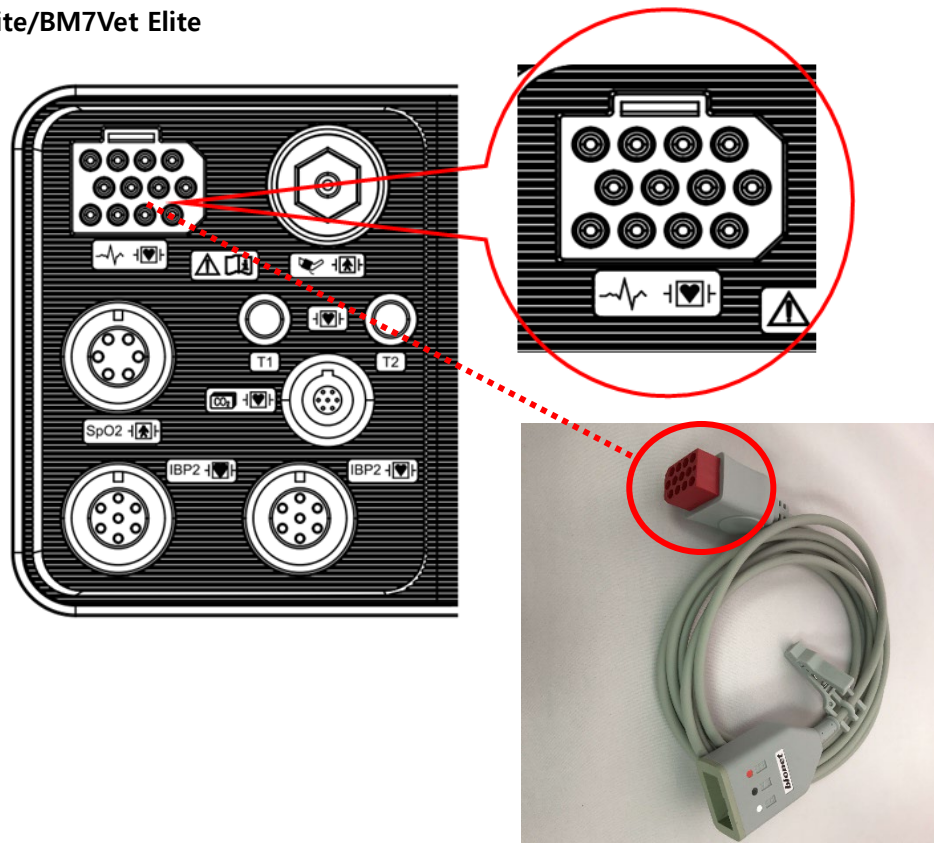

ECG Precaution

Warning

CABLES — Route all cables away from animal's throat to avoid possible strangulation.

CONDUCTIVE CONNECTIONS — Extreme care must be exercised when applying medical electrical equipment. Many parts of the human/machine circuit are conductive, such as the animal, connectors, electrodes, transducers. It is very important that these conductive parts do not come into contact with other grounded, conductive parts when connected to the isolated animal input of the device. Such contact would bridge the animal's isolation and cancel the protection provided by the isolated input. In particular, there must be no contact of the neutral electrode and ground.

DEFIBRILLATION — Do not come into contact with animals during defibrillation. Otherwise serious injury or death could result.

To avoid the risk of serious electrical burn, shock, or other injury during defibrillation, all persons must keep clear of the bed and must not touch the

animal or any equipment connected to the animal.

After defibrillation, the screen display recovers within 10seconds if the correct electrodes are used and applied in accordance with the manufacturer's instructions.

Patient cables can be damaged when connected to an animal during defibrillation. Check cables for functionality before using them again.

The peak of the synchronized defibrillator discharge should be delivered within 60ms of the peak of the R wave. The signal at the ECG output on the Veterinary Multiparameter monitor s is delayed by a maximum of 30ms.

If the ECG waveform on the screen is too unstable to synchronize with the animal's heart beat because of the following reason, remove the cause of an alarm, message, or unstable ECG, and then use a stable ECG lead for synchronization.

- ✓ ECG electrode is detached or broken. Lead wire is detached or broken.
- ✓ Lead wire moves. AC interference, EMG noise or noise from ESU is superimposed.
- ✓ Connection cable is broken or has a short circuit. Connector has poor contact.

INTERFACING OTHER EQUIPMENT — Devices may only be interconnected with each other or to parts of the system when it has been determined by qualified biomedical engineering personnel that there is no danger to the animal, the operator, or the environment as a result. In those instances where there is any element of doubt concerning the safety of connected devices, the user must contact the manufacturers concerned (or other informed experts) for proper use. In all cases, safe and proper operation should be verified with the applicable

Manufacturer's instructions for use and system standards IEC 60601-1-1/EN 60601-1-1 must be complied with.W

Electro surgery Unit

- ✓ Electrosurgical unit (ESU) emits a lot of RF interference. If the monitor is used with an ESU, RF interference may affect the monitor operation.
- ✓ Locate the monitor as far as possible from the ESU. Locate them on

opposite sides of the operating table, if possible.

- ✓ **Connect the monitor and ESU to different AC outlets located as far as possible from each other.**
- ✓ **When using this monitor with an electrosurgical unit, its return plate and the electrodes for monitoring must be firmly attached to the animal. If the return plate is not attached correctly, it may burn the animal's skin where the electrodes are attached.**

Animal Preparation

Careful skin preparation and proper electrode placement allow you to receive a strong signal. If a technical alarm (e.g., lead disconnect) has occurred, prepare the animal again according to the following recommendations.

Follow hospital approved clinical procedures to prepare the animal's skin. Change the electrode every 24 to 48 hours to improve signal quality. You may need to replace the electrode more often in the following situations:

- ECG signal degradation
- Excessive sweating of the animal
- Animal's skin irritation

There are a variety of reusable and disposable electrodes available. Choose the electrode that best fits your monitoring situation. Bionet recommends Ag / AgCl disposable electrodes.

If you are using an electrode with a gel beforehand, make sure that the electrode is sufficiently gelled. Never use this product if the disposable electrode has expired or the gel is dry.

Determine the electrode location that will provide the best ECG in the configuration (P-wave and T-wave amplitudes should not exceed 1/3 of the QRS amplitude). Choose a flat, non-muscular location to maximize contact with the electrodes and minimize muscle fatigue.

Avoid joints or bony protrusions. When choosing a location for electrode placement, consider the following special conditions:

- Surgery - Place electrodes as far away from the surgical site as possible.
- Burn animal - use sterile electrodes. Thoroughly clean the equipment. Follow hospital infection control procedures.

Use a waterproof tape (about 2 inches wide) or Steri-Drape to secure the electrode. Protect from liquids. Make a small loop from the lead wire just below the connection and secure with tape.

Connector and Measurement cable

ECG connector

BM3Vet Elite

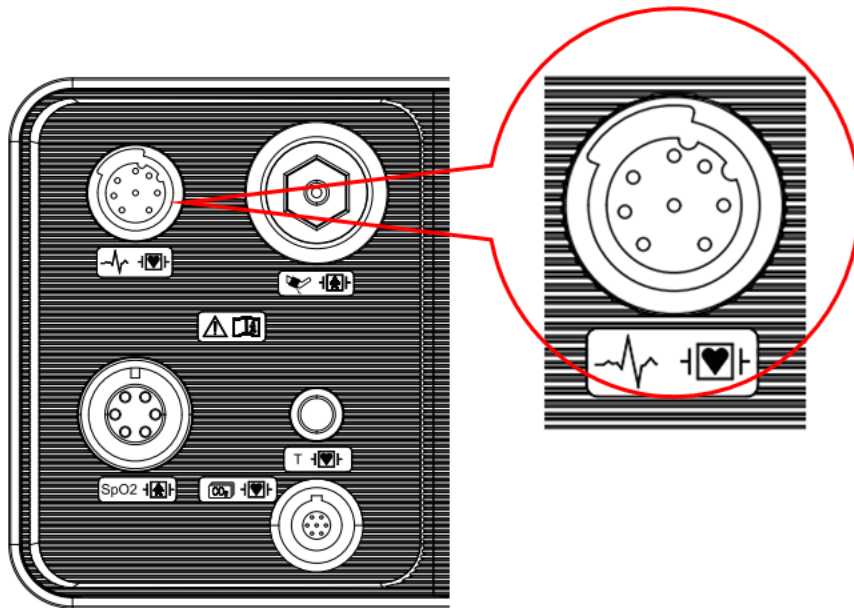

BM5Vet Elite, BM7Vet Elite

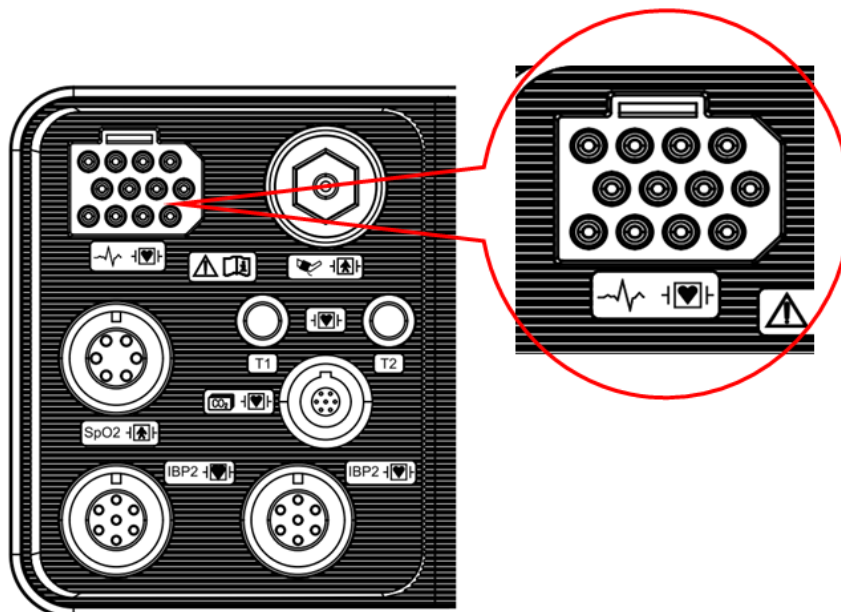

Electrode placement

1. If animal has a lot of hair, shave it. With alcohol-soaked cotton, wipe the animal's skin to attach the electrode. Avoid wrinkled or uneven skin and wipe off alcohol with a dry cotton towel.
2. Unpack the electrode package and pick up the electrode
3. Remove the rear mounting surface of the electrode. Be careful not to touch the adhesive side.
4. Attach disposable electrodes to the previously sterilized skin.
5. Connect the lead of the electrode and the wire of the monitor
6. Fix the electrode to the skin, secure the cable with the remaining length between the instrument, and the electrode with surgical tape. This fixation prevents the electrode from moving.

Note	<p>Make sure that the contact area of the disposable electrode is not dry to maintain a good connection between the electrode and the skin.</p> <p>If you suspect that the disposable electrode is in poor contact, replace it immediately with a new electrode. Otherwise, the contact impedance of the skin and electrode will increase, and the correct ECG signal will not be obtained.</p> <p>If the contact condition gets worse before expiration date on the packaging, replace with a new one.</p> <p>To get a stable ECG waveform, rub the skin with gel or benzoin tincture.</p>
-------------	---

Caution	<p>Use caution when using potential triggering equipment as it may interfere with ECG monitoring.</p> <p>Do not rely entirely on ECG in patients with epilepsy tendencies. Electrical noise from non-cardiac sources, such as seizures, can interfere with the detection of certain arrhythmias</p>
----------------	---

ECG Lead

5 Positions of 5 Lead Placement

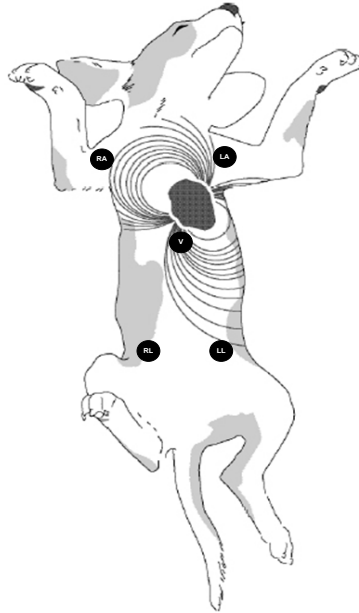

3 Positions of 3 Lead Placement

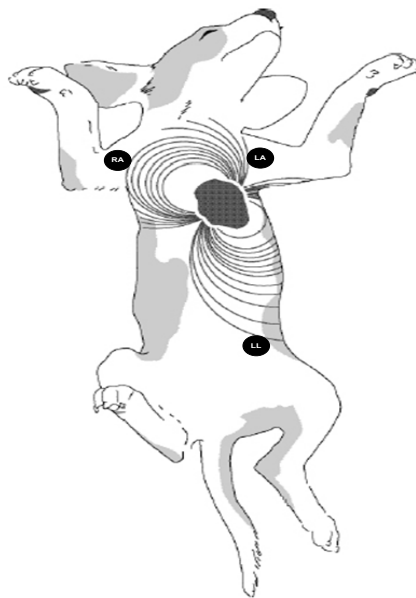

ECG Cable color

AHA : American Heart Association (U.S.A.)

IEC : International Electrotechnical Commission (Europe)

3LEAD / 5LEAD

Lead wire	AHA Color code	AHA Label	IEC Color code	IEC Label
Right arm	White	RA	Red	R
Left arm	Black	LA	Yellow	L
Right leg	Green	RL	Black	N
Left leg	Red	LL	Green	F
V1(precordial)	Brown	V1	White	C1

ECG Signal Processing and Display

The monitor displays QRS Complex for an amplitude of 0.4 to 5.0 mV (0.2 -5.0 mV for scale settings below 0.5 mV / cm) and a QRS width of 70 to 120 ms for large animals (also for small animals with 40 to 100 ms). The heart rate is calculated from 15 to 300 times per minute using the last 10 seconds of the R-R interval and the two longest intervals and the two shortest intervals at the R-R interval. The remaining interval is averaged, and the current heart rate is displayed in the HR parameter box of the main screen as a result.

If arrhythmia monitoring is possible, the HR parameter box will change accordingly. If you select Basic, you can display three basic life threatening arrhythmias called ASYS, VFIB, and VTAC. If Full is selected, a separate ARR parameter box will be displayed next to the HR parameter box (for details on selecting the arrhythmia mode, refer to the Arrhythmia Setting chapter).

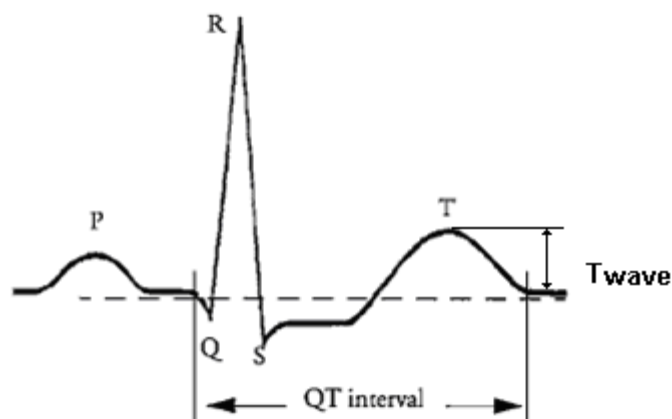

When the ECG signal is 80 BPM, the interval of the T wave is 180 ms, and the QT period is 350 ms.

ST Signal Processing and Display

ST segment deviation is defined as the movement above or below the equipotential level (mm). The difference measurement compares the isoelectric point with the ST measurement point. The isoelectric point defines a zero volt point (no electrical activity, 0 mm) with a base position on the horizontal axis (in hours) of 28ms before QRS complex generation. In the ST segment, the ST point occurs between the QRS offset (J point) and the T-wave. The default position is 80ms after the QRS offset.

The ST analysis method examines ECG signals classified as "normal" beats on up to seven selected ECG leads. The monitor measures the ST level of the normal bit ECG signal and displays the deviation from the average ST level value. If ST monitoring is active, the trend of the ST level can be reviewed in the trend display window.

Alarm and Alarm Status

High P-wave and T-wave, Long P-wave or T-wave with high amplitude duration can be detected by QRS Complex. Place the leads on the ECG1 channel with the highest R-wave (compare to T-wave and / or P-wave) to allow the monitor to properly detect low heart rate conditions in this situation. If the monitor continues to misinterpret the P-wave or T-wave, use a pulse oximeter to reposition the electrodes or monitor the animal's pulse rate.

Display

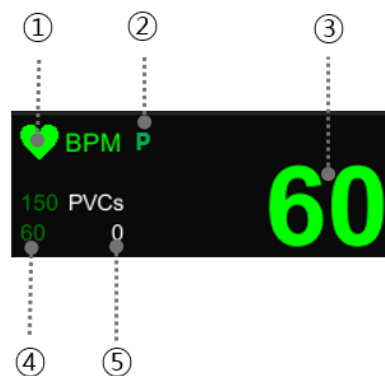

- ① Heart rate detector: It detects heart rate and flickers simultaneously.
- ② Pacemaker: Pacemaker signal is detected and flashes simultaneously.
- ③ Heart rate: Displays the heart rate per minute.
- ④ HR Alarm limits: Heart rate upper and lower thresholds are displayed.

- ⑤ PVC count number per 1 minute is display.

ECG Settings

	Main menu	Sub menu
ECG	A. ECG Parameters	A-1. Alarm
		A-2. QRS Volume
		A-3. Display Option
		A-4. Arrhythmia
		A-5. ST/PVC
		A-6. Pacemaker

A. ECG menu		
Menu	Description	Available settings
A-1. Alarm	ECG alarm setting menu	
A-1-1. Parameter alarm limit	HR, ST, PVC parameter alarm limits, level, activation setup menu.	
A-1-2. Technical alarm condition	ECG-cableoff ¹⁾ ECG-leadfault ECG-checkelectrode ECG-HR-search	
A-2. QRS volume	QRS detection volume setting menu. When you set the SpO2 volume, it is automatically set to Off.	Off, 0%~100%
A-3. Display option		
A-3-1. Sweep speed	The speed of the ECG displayed on the screen can be set. Default setting: 25mm/s	6.25mm/s, 12.5mm/s, 25mm/s, 50mm/s
A-3-2. Filter	The filter setting is MONITOR by default. ECG FILTER : Selects among four frequency bands to filter the signal. MONITOR 0.5Hz ~ 40Hz	MONITOR MODERATE MAXIMUM DIAGONOSIS

	<p>MODERATE 0.5Hz ~25Hz</p> <p>MAXIMUM 5Hz ~ 25Hz</p> <p>DIAGNOSIS 0.05Hz ~150Hz</p>	
A-3-3. Size (sensitivity)	Changes the display amplitude of the ECG waveform.	0.25, 0.5, 1, 2, 4mm/mV
A-3-4. HR source	The cardiac source can be selected as ECG or SpO2, AUTO.	ECG, SpO2, AUTO
A-3-5. View channel	<p>Set the number of channels of ECG waveform to be displayed on the screen.</p> <p>When selecting 1CH, ECG waveform of 1CH is displayed in two lines.</p> <p>3LEAD: Only 1CH is displayed</p> <p>5LEAD: 1CH, 2CH, 7CH display</p>	1CH, 2CH ¹⁾ , 7CH ¹⁾
A-3-6. Trace 1, Trace 2	<p>The ECG channel is selectable from I to V</p> <p>When using the 3 lead cable selection, only TRACE I can select I, II, III.</p> <p>When using 5 lead cable selection, I, II, III, aVR, aVL, aVF, V can be selected.</p>	I, II, III, aVR, aVL, aVF, V
A-4. Arrhythmia	Arrhythmia alarm setting menu	
A-5. ST/PVC	PVC Diagnostic setting, ST template channel selection, ST analysis and ISO (R-) / ST (R +) value setting	
A-5-1. PVC analysis	PVC Diagnostic Results Display Setup Menu	ON/OFF
A-5-2. ST template Ch	ST Diagnostic ECG Channel Setup Menu (Menu display according to the currently connected cable)	Lead I, II, III, aVR, aVL, aVF, V
A-5-3. ST analysis	ST Diagnostic ECG Channel Setup Menu	
A-5-4. ISO(R-)	ISO Point Position Setting Menu	120 ~ 4ms
A-5-5. ST(R+)	ST point position setting Menu	4~160 ms
A-5-6. Initial setup	ISO, ST point position initial value setting Menu	ISO: 80 ST: 108
A-6. Pacemaker	Pacemaker detection display setting	ON/OFF

¹⁾ : BM5Vet Elite, BM7Vet Elite models only

Trouble Shooting

Problem	Solution
Inaccurate heart rate and/or false asystole.	<p>Check ECG signal from patient:</p> <ol style="list-style-type: none"> 1. Check/adjust lead placement. 2. Check/perform skin preparation. 3. Check/replace electrodes. <p>Check amplitude of ECG waveform:</p> <ol style="list-style-type: none"> 1. Select ECG parameter label. 2. Select DISPLAY LEAD, 3. Scroll through all ECG leads and check for 0.5mV amplitude at normal (1X) size. (at least 0.5mV amplitude is required for QRS detection.) for borderline signals, validate on a graph. 4. If amplitudes are low, electrodes may need to be repositioned or replaced.
False ventricular fibrillation occurrence	<p>Check ECG signal from patient: (the chest lead may exhibit polarity changes which may occasionally cause an inaccurate call.)</p> <ol style="list-style-type: none"> 1. Check/adjust electrode placement. 2. Check the electrode attachment to the skin and attach it correctly. 3. Check the condition of the electrode and replace it if necessary. (if chest lead is a problem, move the chest electrode to another chest position or leg position.)
Inaccurate pacemaker detection	<p>Use pacemaker processing:</p> <ol style="list-style-type: none"> 1. Select ECG parameter label. 2. Display the lead of ECG with the greatest amplitude in the top waveform position. 3. Select Pacemaker. 4. SELECT PACEMAKER ON.

8. Arrhythmia Monitoring

Overview

Arrhythmia monitoring is available for selected modes. The selected mode (Full, Lethal or OFF) determines which events are processed. The monitor compares the received beats to the reference beats that have been recorded and stored in the reference template. Through this process, the monitor can identify the occurrence of an arrhythmia event, classify it, and then draw clinically useful conclusions based on the frequency and type of the signal. The monitor will observe all beats in question if the baseline moves beyond a defined limit. The monitor uses QRS processing results for arrhythmia analysis. During multiple lead arrhythmia treatment, the machine measures the QRS Complex of each lead and compares it to the main learned beats. The monitor classifies the beats based on information obtained from all available leads.

Arrhythmia Template

Template	Description
ASYSTOLE	Ventricular asystole occurs whenever the displayed heart rate drops to zero.
VTAC/ VFIB	Ventricular fibrillation occurs when the ECG waveform indicates a chaotic ventricular arrhythmia.
VTAC	Ventricular tachycardia occurs when six or more ventricular beats are detected when the average heart rate is greater than or equal to 150 beats per minute.
ACC VENT¹⁾	Accelerated ventricular occurs when six or more ventricular beats are detected with an average heart rate for the ventricular beat between 50 and 100 beats per minute.
BIGEMINY¹⁾	Occurs when two or more bigeminal cycles (a ventricular beat followed by a non-ventricular beat) are detected.
BRADY¹⁾	Bradycardia is the average of the most recent eight R-to-R intervals at a heart rate less than the set low heart rate limit.
COUPLET¹⁾	Occurs when two ventricular beats are detected and have non-ventricular beats before and after the couplet. The coupling interval must be less than 600 milliseconds.
IRREGULAR¹⁾	Occurs when six consecutive normal R-to-R intervals vary by 100 milliseconds or more.

PAUSE¹⁾	Occurs when the interval between two consecutive beats exceeds three seconds.
PVC¹⁾	Isolated premature ventricular complexes occur when a premature ventricular beat is detected and has non-ventricular beats before and after.
R ON T¹⁾	Occurs when a ventricular complex is detected within the repolarization period of a non-ventricular beat.
TRIGEMINY¹⁾	Occurs when two or more trigeminal cycles (a ventricular beat followed by two non-ventricular beats) are detected.
V BRADY¹⁾	Ventricular bradycardia occurs when a run of three or more ventricular beats is detected with an average heart rate that is less than or equal to 50 beats per minute.

¹⁾ : BM5Vet Elite, BM7Vet Elite models only

Note	The Brady limit matches the low heart rate limit. If the low heart rate limit is changed, the Brady limit changes.
-------------	---

Arrhythmia Settings

Menu	Description	Available settings
A. ECG menu		
A-1. Arrhythmia	Arrhythmia parameter alarm setup menu	
A-1-1. Arrhythmia type	Arrhythmia diagnosis level setup menu. OFF: Do not perform arrhythmia diagnosis. LETHAL: Performs the detection of Asys, VTAC/VFIB, and VTAC at the selected lead FULL: Performs the detection of all 13 arrhythmia.	OFF, LETHAL, FULL ¹⁾
A-1-2. Arrhythmia alarm condition	Alarm setting menu by arrhythmia type	

¹⁾ : BM5Vet Elite, BM7Vet Elite models only

Warning**VENTRICULAR ARRHYTHMIAS**

The arrhythmia analysis program is intended to detect ventricular arrhythmia. This program is not designed to detect atrial or supra ventricular arrhythmias. In some cases, it may not be possible to distinguish the presence or absence of arrhythmias. Therefore, doctors should analyze the arrhythmia information like other medical information.

SUSPENDED ANALYSIS

Certain conditions can delay the arrhythmia analysis. Detection and alarms associated with arrhythmias do not occur when arrhythmia conditions are delayed. This message is generated when the arrhythmia analysis is delayed:

LEADS FAULT, ALARM PAUSE, ALL ALARMS OFF, DISCHARGED.

9. Respiration

Overview

The monitor measures impedance respiration by sending a high frequency current between two ECG electrodes placed on the animal's chest. At inspiration and exhalation, the electrical resistance (impedance) between the electrodes changes with the contraction and expansion of the chest. You can get respiratory waveforms and beats from these impedance changes.

The monitor can use ECG leads I or II for respiratory detection regardless of the lead selected for QRS processing. The measuring range for impedance breath monitoring is 0 to 155 breaths per minute. The alarm setting range is 5 to 150 breaths per minute.

RESP Precaution

Safety and efficacy of respiration measurement methods for apnea detection have not yet been established.

- This device does not monitor obstructive apnea. Animals in a breathing crisis should be closely monitored.
- Impedance breath monitoring should not be considered the only way to detect breathing stops. Bionet recommends monitoring of additional parameters, such as EtCO₂ and SpO₂, that indicate the animal's oxygen supply status.
- If you use an ESU block or cable, the impedance breath monitor may not work and the pacemaker detection performance may be impaired. If pacemaker detection is activated, ESU interference may be detected as pacemaker extremes.
- Large amplitude pacemaker pulses (>100mV) may interfere with the monitor's respiration measurement or detection capabilities.

Animal Preparation

Skin preparation and lead placement must be properly and carefully monitored in impedance breath monitoring. Doing so will produce reliable results. Follow the same recommendations as for ECG monitoring.

In general, the leads should be placed as clean as possible with the 60Hz noise minimized to make it possible to generate a signal. To improve the RESP signal, use a 5-lead cable set (RL as a neutral electrode). It is recommended that the lead be placed in the maximum expansion and contraction range of the lung, especially if deep breathing is involved.

Avoid the liver and the ventricles of the heart to prevent 60Hz noise from pulsatile blood circulation

Note

Cables and connectors to measure respiration rate (RR) are commonly used with ECG.

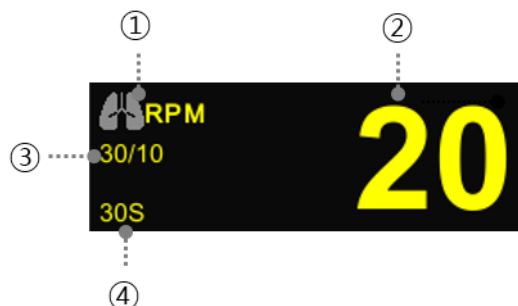
Display

- ① Breathe indicator: indicates the detected breath.
- ② Breathing number: displays the number of respirations per minute.
- ③ Respiration alarm limit: indicates respiration limits.
- ④ Apnea limit Setting: Apnea limit sign

Respiration settings

Menu	Description	Available settings
A. Respiration menu		
A-1. Alarm	RESP alarm setting menu	
A-1-1. Parameter alarm limit	RR, APNEA Parameter alarm, level, activation setup	
A-1-2. Technical alarm condition	RESP - cable off RESP - lead fault RESP - check eletrode	
A-2. Display option	RESP parameter waveform display setup menu	
A-2-1. Sweep speed	A menu to setup Wave Display of speed	6.25mm/s, 12.5mm/s, 25mm/s,
A-2-2. Size	A menu to set the waveform size from X2 to X10.	2, 4, 6, 8, 10

A-2-3. Lead select	This is for changing the reference lead for respiration	Lead I Lead II
A-3. Apnea detect	A menu to setup APNEA alarm display	Off / On

10. SpO2

Overview

SpO2 monitoring is a non-invasive technique that measures the total amount of oxygen in hemoglobin. The pulse rate is measured by measuring the absorption of the wavelength of the selected light. The light emitted by the sensor in the probe passes through the tissue and is converted into an electrical signal by the light-detecting sensor in the probe. The monitor processes the electrical signal and displays the waveform, %SpO2, and pulse rate on the screen as quantified values. Red and infrared light are passed through the capillaries of the animal's tongue to detect pulsating waveforms, calculate pulse rate and blood oxygen saturation, and perform alarm functions according to the set alarm value.

Precaution

SpO2 measurements are particularly sensitive to arterial and arteriolar pulse rates. Animals experiencing shock, hypothermia, anemia, or animals taking medications that reduce arterial blood flow may have incorrect measurements.

Warning

Oximeters cannot be used as apnea monitors.
Check the skin condition by inspecting the application site every 2 to 3 hours, and check whether it is properly attached with the naked eye. If there is a change in the skin, move the sensor to a different area. Change the application area at least every 4 hours.
Use only sensors specified by Bionet. Other sensors may not provide adequate protection against defibrillation or put the patient at risk.
Disposable accessories (disposable electrodes, transducers, etc.) must be used only once. Do not reuse disposable accessories.

Animal preparation

The accuracy of SpO2 monitoring is largely dependent on the strength and quality of the SpO2 signal. Install a sensor at the tip of the animal's tongue for the SpO2 measurement.

Only use sensors provided by Bionet and apply them according to manufacturer's recommendations on a per-sensor basis.

If the sensor is not attached correctly, the ambient light may interfere with the pulse oximetry,

making the measurement irregular or causing the value to disappear. If you suspect interference from ambient light, make sure that the sensor is properly positioned and that the sensor cover with the opaque body is covered.

1. Select the sensor type and size that best suits your animal.
2. If the sensor can be reused, please wash it before use for each animal.
3. Position the sensor correctly and attach it to the animal.
4. Connect the sensor to the patient cable.
5. Check the application area of the sensor from time to time. Fix the sensor so that it does not move.

Note

Read the documentation that came with your sensor for the best application technology and safety information. Never use a damaged sensor.

If the sensor does not turn on after connecting the sensor, observe that a message appears on the monitor. If the sensor-LED does not turn on, replace the sensor.

Connector and Measurement Cable

SpO2 connector

BM3Vet Elite

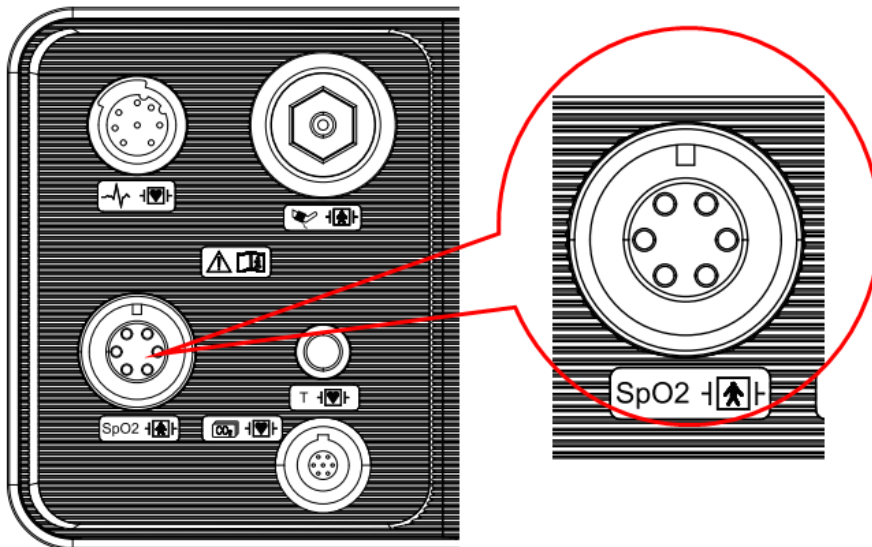

BM5Vet Elite, BM7Vet Elite

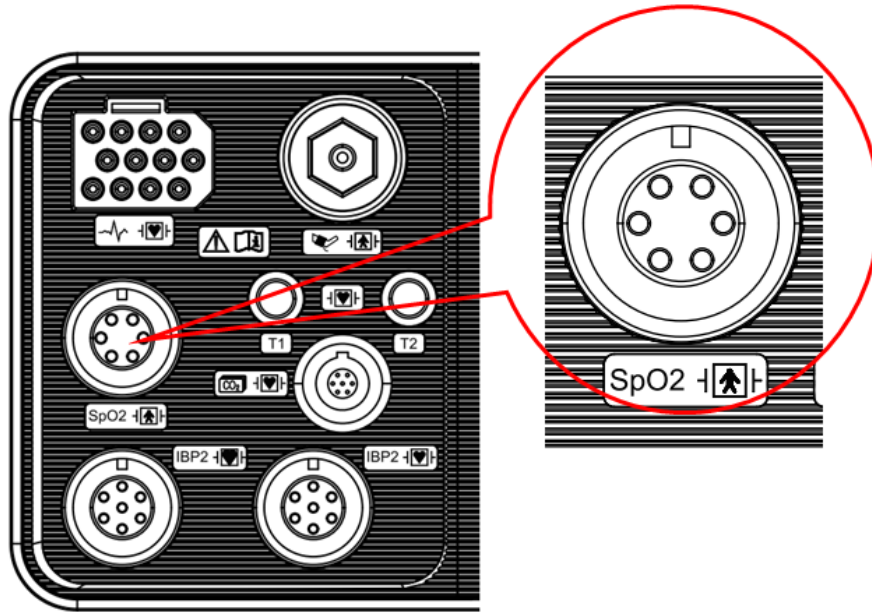

SpO2 measurement Cable



<p>Note</p>	<p>The signal input is a high-insulation port and it is defibrillator proof. The insulated input ensures animal safety and protects the device during defibrillation and electro surgery.</p>
--------------------	---

Display

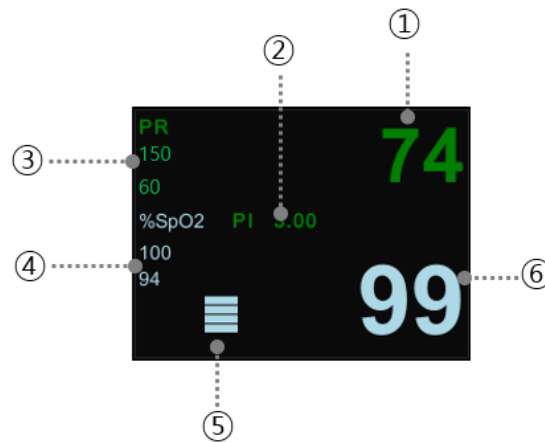

BM5Vet Elite, BM7Vet Elite

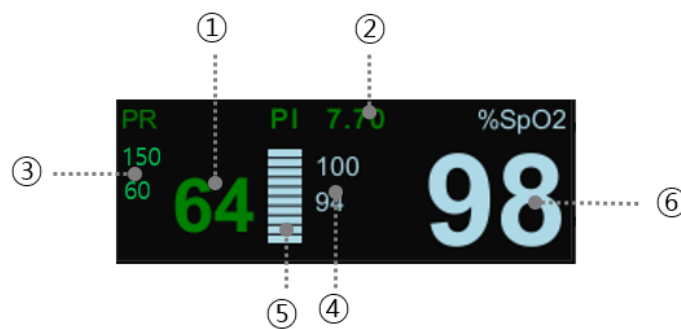

- ① SpO2 pulse rate display
- ② SpO₂ PI (Perfusion Index) display
- ③ Pulse rate Alarm limits display
- ④ SpO₂ Alarm limits display
- ⑤ SpO₂ strength indicator
- ⑥ %SpO₂ Value display

The current SPO₂ value and the derived pulse rate (RATE) are displayed as shown above. The block set indicates the strength of the signal (ten block bars indicate the strongest signal). The SPO₂ measurements are averaged over a 6-second period.

The monitor display is updated every second.

Note	SpO2 wave size changes automatically
-------------	---

Signal and Data Validity

It is extremely important to determine that the probe is attached to the animal correctly and the data is verifiable. To make this determination, three indications from the monitor are of assistance—signal strength bar, quality of the SPO2 waveform, and the stability of the SPO2 values. It is critical to observe all three indications simultaneously when ascertaining signal and data validity.

Signal Strength Bar

The signal strength bar is displayed within the SPO2 values window. This bar consists of 10 blocks set depending on the strength of the signal. Proper environmental conditions and probe attachment will help to ensure a strong signal.

Quality of SPO2 Waveform

Under normal conditions, the SPO2 waveform corresponds to (but is not proportional to) the arterial pressure waveform. The typical SPO2 waveform indicates not only a good waveform, but helps the user find a probe placement with the least noise spikes present. The figure below represents an SPO2 waveform of good quality.

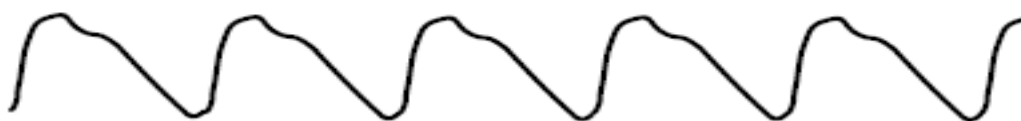

Good Quality SPO2 Waveform

If noise (artifact) is seen on the waveform because of poor probe placement, the photo detector may not be flush with the tissue. Check that the probe is secured and the tissue sample is not too thick. Pulse rate is determined from the SPO₂ waveform which can be disrupted by a cough or other hemodynamic pressure disturbances. Motion at the probe site is indicated by noise spikes in the normal waveform. (See the figure below.) In order to reduce motion noise, you should carefully look at the SpO₂ waveform and check the probe position in the animal.



SPO2 Waveform with Artifact

Stability of SPO2 Values

The stability of the displayed SPO₂ values can also be used as an indication of signal validity. Messages are provided in the SPO₂ values window to aid you in successful SPO₂ monitoring.

Warning

In the monitoring of animals, it is possible that adverse conditions may lead to a disturbed signal going unnoticed. In this situation, artifacts can simulate a plausible parameter reading, so that the monitor fails to sound an alarm. In order to ensure reliable animal monitoring, the proper application of the probe and the signal quality must be checked at regular intervals.

SPO2 Settings

Menu	Description	Available settings
A. SpO2 menu		
A-1. Alarm	SpO2 alarm setup menu	
A-1-1. Parameter alarm limit	Percent, PR parameter alarm, level, activate setup	
A-1-2. Technical alarm condition	SpO2 - probeoff SpO2 - checkprobe SpO2 - poorsignal SpO2 - lostpulse SpO2 - artifact SpO2 - pulse search	
A-2. Rate volume	Menu in which rate volume is set up when the ECG volume is set, it is automatically set to Off.	Off, 0%~100%
A-3. Display option	SpO2 waveform display setting	

A-3-1. Sweep speed	It can set the speed of SpO2 displayed on the screen. Default: 25 mm/s.	6.25mm/s, 12.5mm/s, 25mm/s, 50mm/s
---------------------------	---	------------------------------------

SpO2 Status Messages

Below is a list of system status alarm messages which may be displayed in the SPO2 parameter window during monitoring.

Message	State
Check probe	Occurs when a probe separates from an animal. Check out the Probe.
Pulse search	Detection by the monitor of a repeatable pulse has ceased. Check the animal and the probe site.
Poor signal	The SpO2 signal is too low. No SPO2 data is displayed. This can be due to a low veterinary animal pulse, animal motion, or some other interference. Check the animal and the probe.
Lost signal	SpO2 data continues to be displayed, but the quality of the signal is questionable. Check the animal and the probe.
Artifact	It indicates that something happened to the pulses; determine if the artifact to be abnormal and irregular

Cleaning

- Do not autoclave, pressure sterilizes, or gas sterilizes.
- Do not soak or immerse the monitor in any liquid.
- Use the cleaning solution sparingly. Excessive solution can flow into the monitor and cause damage to internal components.
- Do not touch, press, or rub the display panels with abrasive cleaning compounds, instruments, brushes, rough surface materials, or bring them into contact with anything that could scratch the panel.
- Do not use petroleum-based or acetone solutions, or other harsh solvents, to clean the oximeter. These substances attack the device's materials and device failure can result.

If the accuracy of any measurement does not seem reasonable, first check the animal's vital signs by alternate means and the pulse oximeter for proper functioning.

Inaccurate measurements may be caused by:

- Incorrect sensor application or use

- Significant levels of dysfunctional hemoglobins. (e.g., carboxyhemoglobin or methemoglobin)
- Intravascular dyes such as indocyanine green or methylene blue.

11. NIBP

Overview

The monitor can acquire and process non-invasive blood pressure (NIBP) signals and display the numerical values. NIBP can also be used during electrosurgery.

Blood pressure measurements are determined by the oscillometric method and are equivalent to those obtained by intra-arterial methods, within the limits prescribed by the Association for Advancement of Medical Instrumentation, Electronic Automated Sphygmomanometers (AAMI/ANSI SP-10).

The hose connects the cuff to the monitor to determine the contraction, expansion and mean blood pressure of animals. The monitor can start the blood pressure measurement with set intervals or persist for more than 5 minutes.

Connector and Cuff

BM3Vet Elite

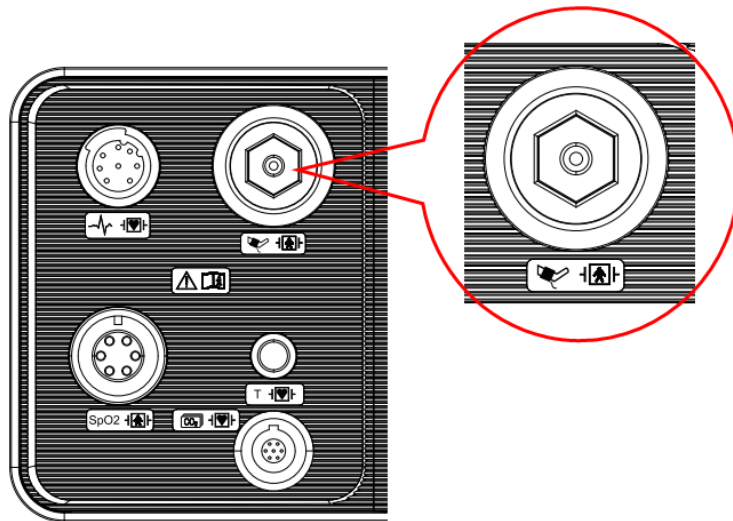

BM5Vet Elite/BM7Vet Elite

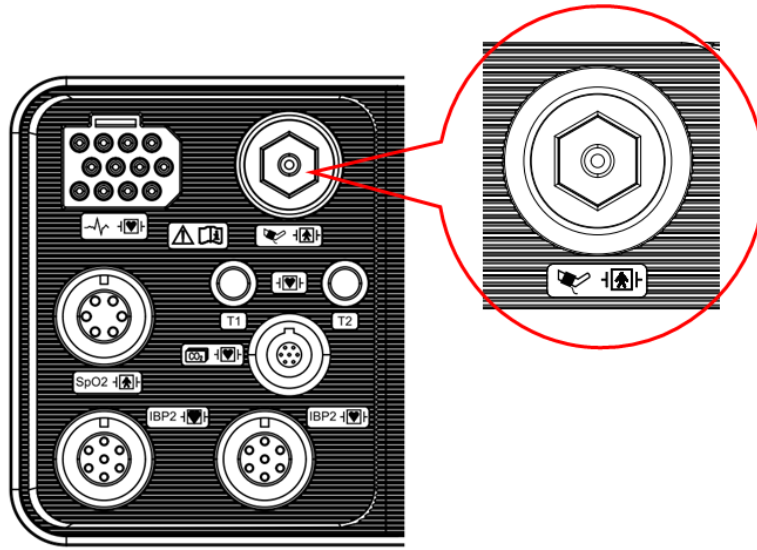

Cuff (for USA only)



Position of cuff



Incorrect Placement



Correct Placement

The hose should line up with the vessel that you are trying to measure. When using a leg, this is on the underside (backside) of the leg.

Note: The cuff must be at the same level as the patient's heart for best accuracy.

Display

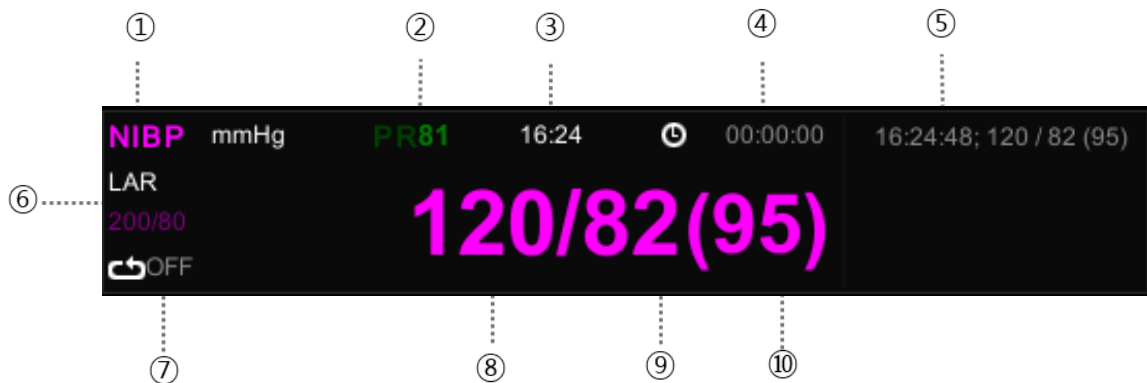

- ① Measurement Cuff type.
- ② Pulse rates: Indicates pulse rate.
- ③ Measurement time: Indicates the completion time of measuring.
- ④ Measure time: Indicates the schedule counter time of measuring.
- ⑤ Current Measurement data: Indicates recent measurement.
- ⑥ Systolic Alarm limit: Indicates alarm limit of blood pressure.
- ⑦ Interval Time: indicates interval time when the blood pressure is measured.
- ⑧ Systolic blood pressure: Indicates the maximum blood pressure.
- ⑨ Diastolic blood pressure: Indicates the minimum blood pressure.
- ⑩ Mean blood pressure: Indicates the average blood pressure.

NIBP Settings

Menu	Description	Available settings
A. NIBP menu		
A-1. Alarm	NIBP alarm setup menu	
A-1-1. Parameter alarm limit	SYS, MEAN, DIA parameter alarm limit, level, activation setup	
A-1-2. Technical alarm condition	NIBP - over pressure NIBP - overtime pressure NIBP - inflation failure NIBP - deflation failure NIBP - measurement error	

	<p>NIBP - pulse too weak</p> <p>NIBP - air leak</p> <p>NIBP - excessive motion</p> <p>NIBP - system fault</p>	
A-2. Cuff size	<p>A menu to select cuff size</p> <p>* When changing the cuff, be sure to adjust the actual size of the cuff and the size of the cuff set on the equipment.</p>	<p>SMALL (~ #3)</p> <p>LARGE (#4 ~)</p>
A-3. Inflation	<p>A function to set the range that is usually used by setting pressure at the beginning because it can give pain for the animal when the equipment is turned on and pressurized to the maximum pressure range at the initial pressurization.</p> <p>Default Settings value: SMALL: 60-140mmHg LARGE: 120-250mmHg</p>	<p>SMALL: 60-140mmHg</p> <p>LARGE: 120-250mmHg</p>
A-4. Setting time	<p>How to apply pressure value setting.</p> <p>Once: When the blood pressure is measured for the first time, the pressure is set to the set pressure value, but automatically adjusted according to the animal's blood pressure value.</p> <p>Every time: Whenever blood pressure is measured, pressurize to the set pressure value every time</p>	<p>Once,</p> <p>Every time</p>
A-5. Measurement Interval	<p>A menu to set Interval time when the blood pressure is measured.</p> <p>After setting INTERVAL, you must press NIBP KEY to start NIBP measurement.</p>	<p>1min, 2, 3, 4, 5, 10, 15, 20, 30, 60, 90, 2 hours, 4, 8</p>
A-6. Vital sign review	<p>Record the last 40 blood pressure readings.</p>	

Warning	<p>Check periodically to see if the circulation from the cuff to the distal part of the animal's limb is good.</p> <p>1minute and 2minute intervals when using automatic measurement, check the animal's condition frequently. It is not recommended for measuring blood pressure for a long time if the measurement time period is set to 10minutes or less.</p> <p>When changing the cuff, be sure to adjust the actual size of the cuff and the size of the cuff set on the equipment.</p>
----------------	---

Note	<p>Safety Considerations</p> <p>Software and hardware for cuff pressure isolation</p> <p>If the measurement time is more than 2 minutes in cat/dog/horse mode and more than 90 seconds in dog mode, the cuff is automatically reduced. Extension limits are set for all patient categories to prevent overpressure in the patient.</p> <p>Maintenance is carried out every two years.</p> <p>Always check the following list for proper operation and safety.</p> <ol style="list-style-type: none"> 1. Confirm proper cuff size. 2. Check that there is no air left in the cuff from the previous measurement. 3. Make sure the cuff is not too tight or too loose. 4. Make sure the cuff and heart are level. Otherwise, the hydrostatic pressure will cancel the NIBP value. 5. Minimize movement of the patient's axis during measurement. 6. Beware that your pulse is not real. 7. Check cuff or tube for leaks. 8. The patient may have a weak pulse.
-------------	---

Measurement Limitations

The measurement may be inaccurate or impossible:

- Measurements are impossible with heart rate extremes of less than 40 bpm or greater than 300 bpm, or if the patient is on a heart-lung machine.
- With excessive and continuous patient movement such as shivering or convulsions
- if a regular arterial pressure pulse is hard to detect
- With cardiac arrhythmias
- With rapid blood pressure changes
- With severe shock or hypothermia that reduces blood flow to the peripheries
- With obesity, where a thick layer of fat surrounding a limb dampens the oscillations coming from the artery
- On an edematous extremity.

Cuff Selection and Placement

The quality of NIBP monitoring depends largely on the quality of the signals received by the monitor.

For this reason, it is important to select the correct cuff size for your animal. Cuff sizes are clearly marked on the cuff. Measure the circumference of your animal's limb. Use only Bionet cuffs with your monitor.

Warning

Non-invasive sphygmomanometers are not recommended for use in animals with hypotension, hypertension, arrhythmias, or very high or low heart rates. The software algorithms in the device are not able to accurately measure blood pressure in animals with these symptoms.

Do not apply the cuff to the wound. This can cause more severe injuries.

The NIBP value may vary depending on the cuff size, so you need to set the correct data in the measurement parameter menu settings before measurement.

Make sure the tube between the cuff and the monitor is not kinked or

blocked.

Be careful not to block the connecting hose when putting the cuff on the patient.

Check cuff or hose connections periodically for leaks. Air leaks can cause inaccurate measurements.

The cuff must be positioned exactly in the arterial area.

Even manual methods using a sphygmomanometer and stethoscope do not work for unstable or active animals.

Pressurization of the cuff may result in loss of function of monitoring medical electrical devices used simultaneously on the same limb.

It is necessary to check that the operation of the NIBP does not cause organ damage to the animal's blood circulation.

Status Messages

An error message is displayed in the following situations:

Messages	Description
Inflation failure check cuff	If the cuff hose is not connected properly
Over pressure	When the cuff pressure is excessive
Deflation failure	When the cuff breaks and cannot exhaust
Over time cuff pressure	When the cuff pressure exceeds the set time
Measurement error	When there is no measurement signal

12. Temperature

Overview

The BMVet Elite monitors provide one or two temperature channels depending on model. When both channels are active, the difference temperature (delta icon) is also displayed. You can select degrees C or degrees F.

Connector and Measurement Cable

BM3Vet Elite

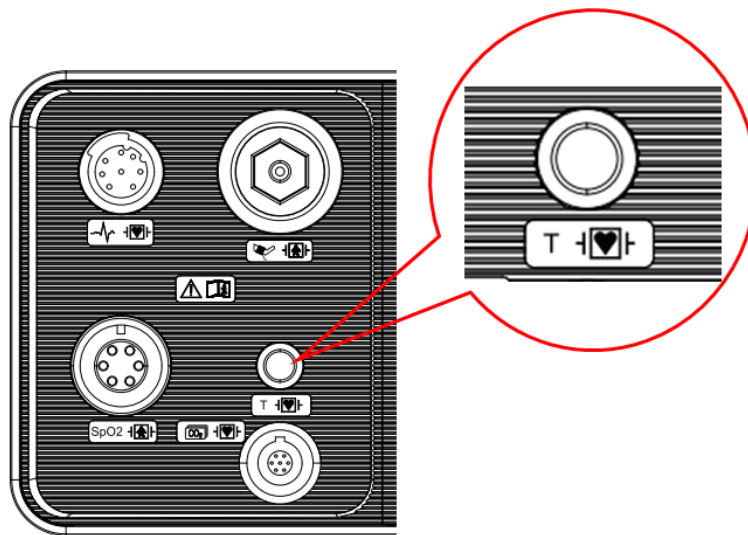

BM5Vet Elite/BM7Vet Elite

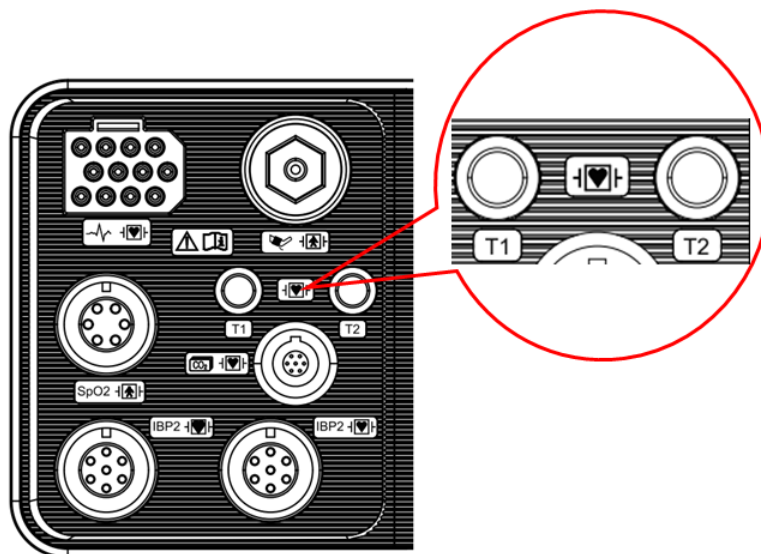

Temperature measuring cable



Note Temperature probe is correctly positioned and fixed not to disconnect on the patient.

Display

BM3Vet Elite

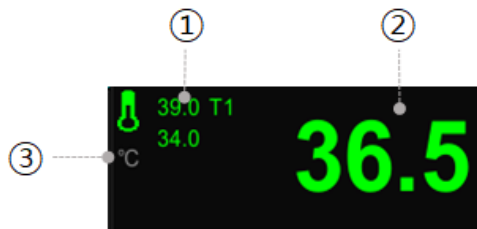

BM5Vet Elite/BM7Vet Elite

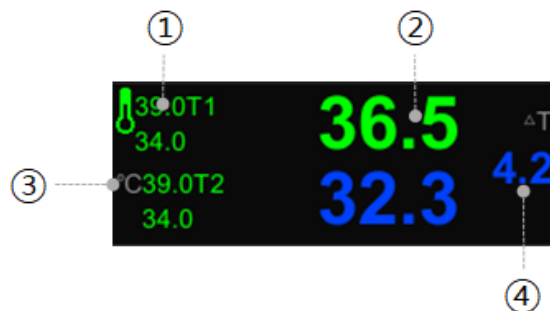

- ① Temperature alarm limit display
- ② Temperature value display
- ③ Temperature unit display
- ④ Temperature difference value display (BM5Vet Elite, BM7Vet Elite only)

Note	<p>The minimum measuring time required to obtain accurate readings at the specific body site is at least 3minutes.</p> <p>If the measurement site is directly exposed to air, the temperature may be lower than normal.</p> <p>It takes about 20 ~ 30minutes to reach temperature equilibrium by attaching this sensor.</p>
-------------	--

Warning	<p>To measure the ambient temperature, attach the probe to the ankle.</p> <p>If the affected axis moves too much, the pad is fixed with surgical tape.</p> <p>The temperature sensor must be connected in the correct position and secured so that it does not detach from the animal. A temperature cable must be connected to the monitor.</p>
----------------	---

Temperature Settings

Menu	Description	Available settings
A. Temp		
A-1. Alarm	Temp alarm settings menu	
A-1-1. Parameter alarm limit	TEMP1, TEMP2, DELTA TEMP Parameter alarm level, action setup menu	0°C ~ 50.0°C (32°F ~ 122°F)
A-1-2. Technical alarm condition	TEMP1-probe off TEMP2-probe off ¹⁾	
A-2. Display option ¹⁾	Temperature waveform display setting	
A-2-1. Delta display ¹⁾	It can set whether to display two temperature differences as a value.	On / Off
A-2-2. Temp. order ¹⁾	It can set the order of the temperature differences.	TEMP1 – TEMP2 TEMP2 – TEMP1
A-2-3. 2 channel view ¹⁾	2 channels display setup.	On / Off

	If only 1 channel is used, set it to off. When using 1 channel, which channel to use is determined by Temp order.	
--	--	--

¹⁾: BM5Vet Elite/BM7Vet Elite only

13. EtCO₂

Overview

BM3Vet Elite / BM5Vet Elite / BM7Vet Elite Veterinary Multiparameter Monitors measures concentrations of end-tidal CO₂ (EtCO₂) when this option is enabled and the EtCO₂ module is connected to your monitor.

The EtCO₂ module can perform mainstream measurements in all monitoring modes as well as sidestream measurements.

Precaution

<p>Warning</p>	<p>Veterinary Multiparameter monitors that measure CO₂, anesthetics, and / or respiratory mechanics cannot be used as apnea monitoring and / or recording equipment. While these products provide an apnea alarm, the alarm condition begins with the elapsed time from when the last breath was detected. However, there are a number of physiological indications for the clinical diagnosis of real apnea events.</p> <p>The CO₂ alarm is not activated until the first breath is detected after the monitor is turned on or the patient is discharged.</p> <p>Accuracy of the CO₂ and breathing rate measurements may be impaired due to improper attachment of the sensor or due to certain patient conditions and certain environmental conditions.</p> <p>If the tube connection is faulty, loose or damaged, gas may leak and the accuracy of the measurement may be lowered, resulting in poor breathing. To prevent this, connect all component is securely and check the connection according to standard clinical procedures to ensure that there are no leaks.</p>
<p>Warning</p>	<p>Industrial safety: Carefully dispose of used sampling tubes and T-connectors as they may cause infection. Dispose of all equipment in accordance with local regulations.</p> <p>Optimize reaction time by minimizing dead space and keeping sample</p>

collection tubes as short as possible. Long sampling tubes can lead to poor accuracy and slow response times for sidestream measurement techniques.

Do not place the airway adapter between the suction catheter and the endotracheal tube when using the sample collection line as a closed suction device for tuberculous patients. This is to ensure that the airway adapter does not interfere with the function of the suction catheter.

Connector and Measurement Accessory

BM3Vet Elite

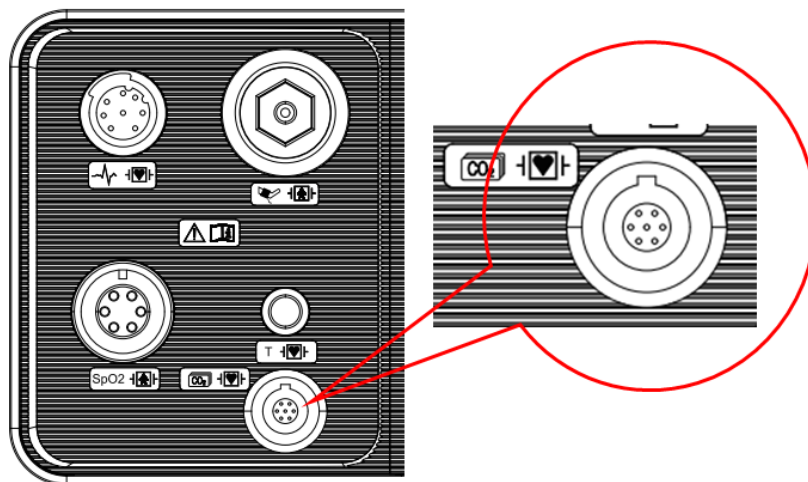

BM5Vet Elite/BM7Vet Elite

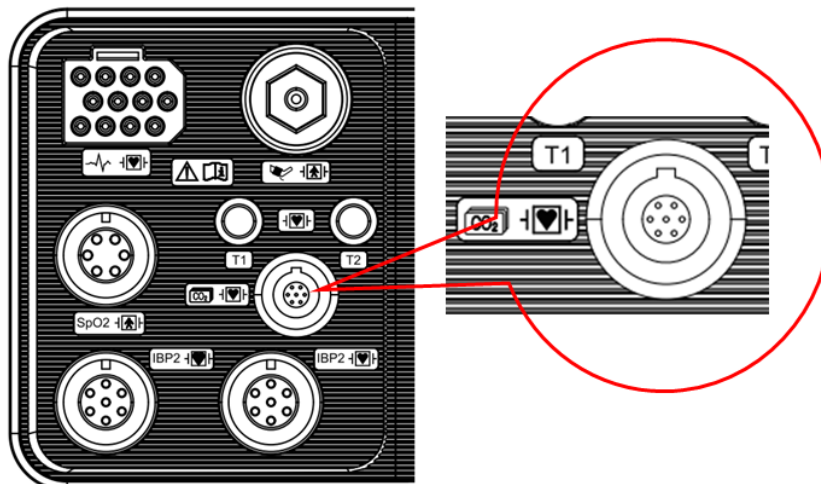

LoFlo sidestream CO2 sensor and connector





Sidestream sensor



Sidestream sensor connector

Sidestream EtCO2 Accessories

Intubation accessories			
3473ADU-00		Airway adapter kit w/ dehumidification tubing	Intended for use when monitoring large animals (Cat / Dog / Horse) with ETTUBE sizes > 4.0 mm
3473INF-00		Airway adapter kit w/ dehumidification tubing	Intended for use when monitoring small animals (Puppy) with ETTUBE sizes ≤ 4.0 mm

CAPNOSTAT 5 mainstream CO2 sensor and connector



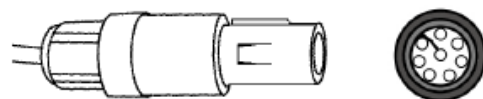

Mainstream Sensor



Mainstream Sensor Connector

Mainstream EtCO₂ Accessories

Intubation animal airway adaptor		
Model	Picture	Description
6063-00		Large animals (Cat / Dog / Horse) (Disposable)
6312-00		Small animals (Puppy) (Disposable)

Display



- ① EtCO₂ CO₂ concentration alarm upper and lower limit value display
- ② Apnea alarm set time in seconds
- ③ Display CO₂ concentration value at exhalation
- ④ Display the carbon dioxide concentration value at inhalation
- ⑤ Show respiratory rate per minute

Sampling Method

Connecting the CAPNOSTAT® 5 CO₂ sensor to the host system

1. Insert the CAPNOSTAT 5 CO₂ sensor connector into the receptacle of the host monitor as shown in Figure 1.

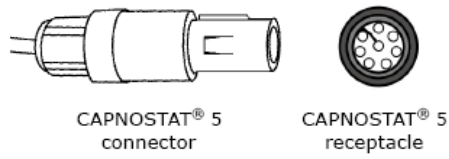
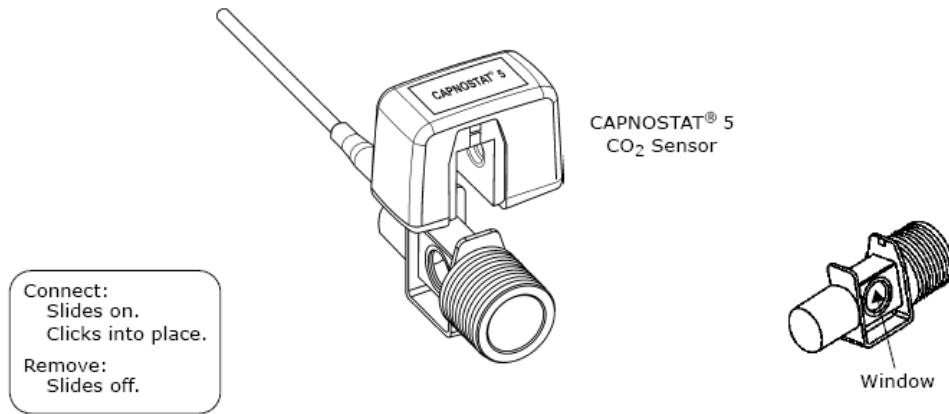

Figure 1

2. Make sure the arrows on the connector are at the top of the connector and line up the two keys of the connector with the receptacle and insert.
3. To remove the connector, grasp the body portion of the connector back and remove.

Note: Do not remove by pulling cable.

Shown below is the CAPNOSTAT 5 CO₂ sensor connection to a Respiration Novamatrix CO₂ adapter.



Shown below is the CAPNOSTAT 5 CO₂ Sensor with a patient circuit

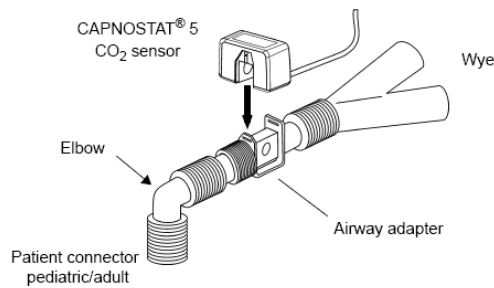

Connecting the LoFlo Sample Kit

1. The sample cell of the sampling kit must be inserted into the sample cell receptacle of the LoFlo CO₂ Module as shown in Figure 1. A “click” will be heard when the sample cell is properly inserted.

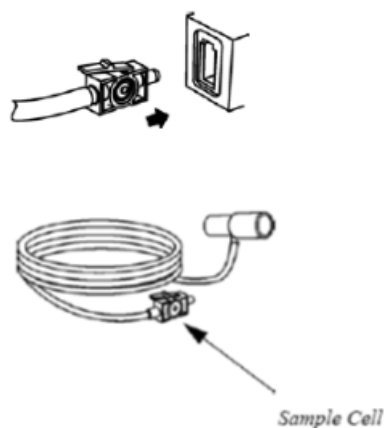

2. Inserting the sample cell into the receptacle automatically starts the sampling pump.
3. Removal of the sample cell turns the sample pump off.
4. To remove the sampling kit sample cell from the sample cell receptacle, press down on the locking tab and pull the sample cell from the sample cell receptacle.

EtCO₂ Settings

Menu	Description	Available settings
A. EtCO₂		
A-1. Alarm	EtCO ₂ alarm setup menu	
A-1-1. Parameter alarm limit	ETCO ₂ , FICO ₂ , AWRR, APNEA parameter alarm, level, action setup	
A-1-2. Technical alarm condition	ETCO ₂ -module off ETCO ₂ -check adaptor ETCO ₂ -check line ETCO ₂ -chekc line disconnect ETCO ₂ -CO ₂ invalid ETCO ₂ -over range ETCO ₂ -zero required ETCO ₂ -system fault ETCO ₂ -temp unstable	
A-2. Display option	EtCO ₂ parameter wave display setup	

A-2-1. Sweep speed	Waveform sweep speed setup	6.25mm/s, 12.5mm/s, 25mm/s
A-2-2. Scale	Display waveform scale setup. The selectable value is the maximum pressure range shown in the waveform. When you select a range value, the selected pressure range value is displayed below the dotted line above the two dotted lines in the left middle of the wave window.	40mmHg (5.3 vol%) 50mmHg (6.6 vol%) 60mmHg (7.9 vol%) 80mmHg (10.5 vol%) 100mmHg(13.2vol%) 150mmHg(19.7vol%)
A-2-3. Fill	Choose whether to fill the waveform inside	On / Off
A-2-4. Gas pressure unit	Choose gas pressure unit	mmHg kPa vol%
A-2-5. Use one gas unit	Choose to set the pressure unit for each gas type Unit setting menu by gas type appears when off.	On / Off
A-3. Apnea detect	APNEA detection menu	On / Off
A-4. Module information	Module information menu	
A-4-1. Sensor PN	The sensor part number	PNXXXXXX
A-4-2. OEM ID	The id is a 7-bit identifier which is set at the factory to a unique value for each OEM.	0X01
A-4-3. sensor SN	The serial number of the module	
A-4-4. H/W version	The hardware version number of the module	
A-4-5. Total usage time	Total use time of the module.	
A-4-6. Last zero time	This is the total time that has elapsed with the sensor in service the last zero.	Min. display
A-4-7. Pump total time	This is the total time the pump has been on. (LoFlo only)	Min. display
A-4-8. Pump max time	This value indicates the maximum rated lifetime of the sampling pump. (LoFlo only)	Min. display
A-5. Module setup	Module setup menu	

A-5-1. Current period	This setting is used to set the calculation period of the ETCO ₂ value. The end-tidal CO ₂ value is the highest peak CO ₂ value of all end of expirations (end of breaths) over the selected time period. If less than two breaths exist in the selected time period, the value will be the maximum ETCO ₂ value for the last two breaths.	1 breath, 10 sec, 20 sec
A-5-2. Balance gas	setup the gas in the measurement; the type of gas that is mixed with the breathing gas measuring	Room air N ₂ O Helium
A-5-3. Sleep mode	Sleep mode is used to save power when the host monitor is in standby mode. There are two sleep modes available for the Capnostat. Using Sleep Mode 1 maintains the heaters so the Capnostat is able to run immediately after exiting the sleep mode. Mode 2 will require the Capnostat to go through its warmup sequence when exiting this mode and a delay will be introduced until the system has stabilized.	Normal mode Turnoff mode Power saving
A-5-4. BARO. pressure	This setting is used to set current Barometric Pressure.	760mmHg
A-5-5. Gas temperature	This setting is used to set temperature of the gas mixture. This setting is useful when bench testing using static gasses where the temperature is often room temperature or below.	35.0 °C
A-5-6. O ₂ compensation	Use this setting to correct for the compensation of the gas mixture administered to the animal.	
A-5-7. Anesthetic agent	Anesthetic agent is ignored when the balance gas is set to helium.	
A-5-8. Zero type	This function is used to initiate a When performing a zero on room air, this setting should be set to room air	Room air N ₂

	(the default). Only change to nitrogen (N ₂) when performing a zero on 100% N ₂ gas; this is provided for use in a laboratory environment.	
B-1. Zeroing	<p>This function is used to initiate a Capnostat zero.</p> <p>A zero is used to correct for differences in airway adapter types. The Capnostat zero must be performed free of any CO₂</p> <ol style="list-style-type: none"> 1. Set the Host to the zeroing function. 2. Connect the CAPNOSTAT 5 CO₂ Sensor. 3. Place the CAPNOSTAT 5 CO₂ Sensor onto a clean and dry CO₂ adapter that is exposed to room air and away from all sources of CO₂, including the ventilator, the animal's breath and your own. <p>Start the adapter zero. The maximum time for a CAPNOSTAT zero is 40seconds. The typical time for a zero is 15~20seconds.</p>	
C-1. Module reset	EtCO ₂ module initializing.	

Note

For best result, connect the CAPNOSTAT 5 CO₂ Sensor to an adapter and wait 2 minutes before performing the Adapter Zero procedure.

Status Message

Following is a list of some of the message that may appear on the monitor when monitoring CO₂. The message should clear when normal operating criteria are met or a solution is found.

Status Message	Cause	Solution
SENSOR OVER TEMP	The sensor temperature is greater than 40°C	Make sure sensor is not exposed to extreme heat(heat lamp,etc.)
SENSOR FAULTY	One of the following conditions exists: Capnostat Source Current Failure EEPROM Checksum Faulty Hardware Error	Check that the sensor is properly plugged in. Reinsert or reset the sensor if necessary.
SENSOR WARM UP	Sensor under temperature, Temperature not stable, Source Current unstable	This error condition is normal at startup. This error should clear when the warm up is complete.
CHECK SAMPLING LINE	This error occurs whenever the pneumatic pressure is outside the expected range.	Check that the sampling line is not occluded or kinked. Replace the sample line
ZERO REQUIRED	Zero Required, Zero Error	To clear, check airway adapter and clean if necessary. If this does not correct the error, perform an adapter zero. If you must adapter zero more than once, a possible hardware error may exist.
CO2 OUT OF RANGE	The value being calculated is greater than the upper CO2 limit(150mmHg)	If error persists, perform a zero.
CHECK AIRWAY ADAPTER	Usually caused when the airway adapter is removed from the Capnostat or when there is an optical blockage on the windows of the airway adapter. May also be caused by failure to perform Capnostat zero to when adapter type is changed.	To clear, clean airway adapter if mucus or moisture is seen. If the adapter is clean, perform a Capnostat zero.
MODULE OFF	It occurs when the equipment and module are separated. Message output	Verify module connections Service request

CO2 measurement failure

CO2 value is not output, or numerical error.

Troubleshoot procedure

1. Check the connection between the main unit and the module.
2. Check the module line connection with the filter line or airway.
3. Replace filter line or airway.
4. Service Request

Note	<p>In the following monitoring conditions, the measured values may be inaccurate. Read the measured values carefully.</p> <ol style="list-style-type: none">1. When using this in an environment of using nitrous oxide gas of high concentration2. When using this in an environment where abrupt temperature change takes place3. When using this in an environment with severely high humidity
-------------	---

Caution	<p>The measured values may be inaccurate when using this equipment for animals who have very fast or irregular respiration.</p> <p>When measuring CO₂ from the animal under the anesthesia, check it when gas mixture comes in. Otherwise, the measured result values may be inaccurate.</p> <p>When using an anesthesia machine that uses a volatile anesthetic, CO₂ values may be inaccurate.</p>
----------------	--

14. Invasive Blood Pressure (BM5Vet Elite/BM7Vet

Elite only)

Overview

IBP has an alarm function based on the maximum & minimum alarming values configured by measuring the systolic, diastolic, and mean blood pressure values with signal processing of electric signals which are transformed from changes in impedance components according to the changes of blood flow in vessels.

Precaution

The following precautions apply to IBP procedures. See the hospital's clinical guidelines for details.

Warning

All parts, except Transducer, should not be conductive. Otherwise discharge energy may induce a shock to operators during cardioversion.

Single-use accessories are not to be reused.

Use of non-approved transducers may compromise this protection.

Note

- Check if there is a scratch on the catheter balloon before using.
- Do not reuse disposal parts and accessories.
- Do not use saline packs with passed expiration dates.
- Do not use pressure measurement kits in torn packages.
- Remove all air in the saline pack by squeezing it. Otherwise, it may cause errors in blood pressure band and may go into the blood vessels.

Connector and measurement kit

IBP connector

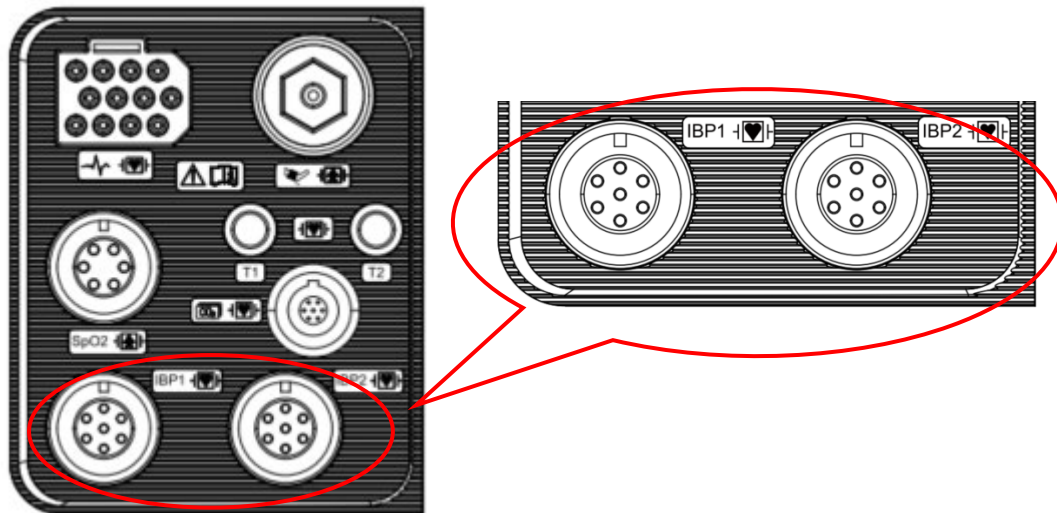

Disposable pressure transducers cartridges and monitoring kit

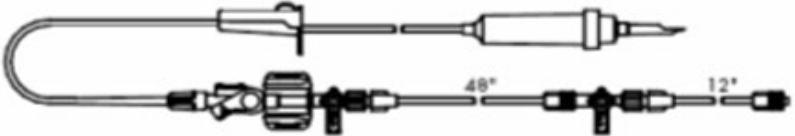
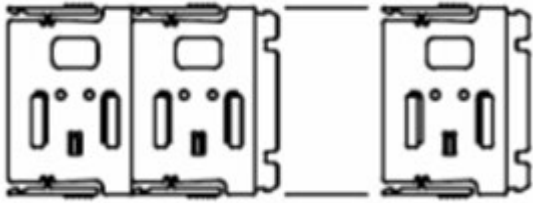
Model No.	Description
MX9504T	TranStar® 60° single line monitoring kit
	
MX800	Modular transducer mounting plate
	
MX240	Pole clamp for mounting a transducer plate

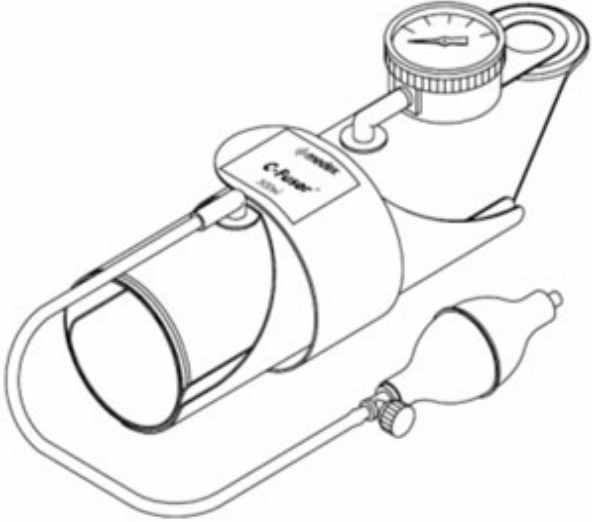
	
MX4810	<p>C-fuser® 1000ml Pressure Infusor complete unit with squeeze bulb and pressure gauge</p> 

Display

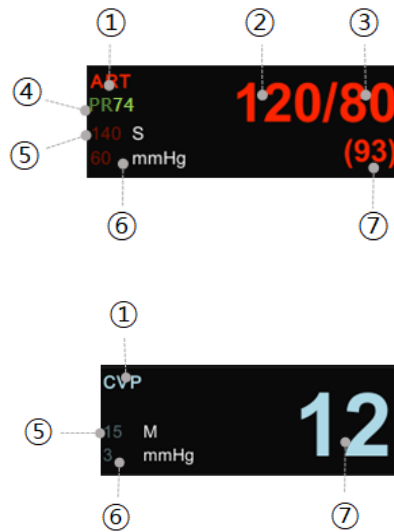

- ① Measuring Position: Position of blood pressure measurement
- ② Systolic Blood Pressure: Indicating maximum blood pressure value
- ③ Diastolic Blood Pressure: Indicating minimum blood pressure value
- ④ Pulse Rate Value
- ⑤ High Alarm Limit: Indicating configured high alarm limit of blood pressure
- ⑥ Low Alarm Limit: Indicating configured low alarm limit of blood pressure
- ⑦ Mean Blood Pressure: Indicating mean blood pressure value

Procedures

Zero reference:

1. Close the transducer stopcock on the animal's side.
2. Open the venting stopcock on the air side.
3. Press the knob switch on the monitor panel.
4. Draw a line with the current input data in IBP area of wave window according to the wave base line. And accord the wave line with the data.
5. Set the data as '0' on the parameter screen.
6. Check if **Zero reference** is carried out. (Check the pressure parameter on the message window.)

7. Close the venting stopcock on the air side.
8. Open the transducer stopcock on the animal side. The pressure value should be displayed on the pressure parameter screen in a few seconds.

Disconnected alarm

Disconn alarm menu will be displayed when measurement label is set for ART, FEM and UAP.

This function will be activated upon the following two conditions.

1. In case **Mean pressure** is not higher than 25mmHg.
2. In case the **Disconnect alarm** is set '**ON**'.

Medium alarming sound will be generated when the **Disconnected alarm** is activated, and the alarming message "**DISCONNECTED**" will be displayed on the parameter screen.

CAL. TRANSDUC:

A function to adjust a Transducer error on the monitor

A function to adjust an error value based on the other index manometer.

How to Adjust

1. Select a menu by pressing the knob switch key.
2. Measure blood pressure along with another index manometer.
3. Compare the measured values of 'mmHg' for both manometers.
4. Adjust the error value on the parameter menu screen by turning knob switch.
5. Terminate the menu by pressing the knob switch key again.

List & Description of IBP Measurement Parameter Label

Parameter window, **Scales menu window** or **Alarm limits pop-up menu** will appear according to the Labels.

IBP displays the measuring positions based on 10 labels shown in the below table.

The below table shows the names for each label and the descriptions to be displayed on the **Parameter Window**.

Select '**Other**' for a measuring position not in the listed positions.

Label	Description	Display value
ART	Arterial blood pressure (arterial tension)	-systolic, diastolic, and mean
FEM	Femoral pressure (femoral artery)	-systolic, diastolic, and mean
PAP	Pulmonary artery pressure (pulmonary arterial pressure)	-systolic, diastolic, and mean
CVP	Central venous pressure	-mean
LAP	Left atrial pressure (Arterial tension left)	-mean
RAP	Right atrial pressure (Arterial tension right)	-mean
ICP	Intracranial pressure	-mean
OTHER	Other (BP1, BP2)	-mean
UAP	Umbilical arterial pressure (Umbilical arterial pressure)	-systolic, diastolic, and mean
UVP	Umbilical venous pressure (Umbilical venous pressure)	-mean

IBP Settings

Menu	Description	Available settings
A. IBP menu		
A-1. Alarm	IBP alarm settings menu	
A-1-1. Parameter alarm limit	IBP-SYS, MEAN, DIA, PR parameter alarm, level, activate setup	
A-1-2. Technical alarm condition	IBP-cableoff IBP-disconnect	
A-2. BP filter	Menu to set the filter to be applied when measuring OFF: 0Hz ~ 40Hz 12Hz: 0Hz ~ 12Hz: Generally recommended for monitoring 20Hz: 0Hz ~ 20Hz: It is used to process higher frequency waveform components, and when this	OFF 12Hz 20Hz

	filter is used, the pressure value can rise.	
A-3. Display option	IBP waveform display setting	
A-3-1. Sweep speed	Set the speed of IBP displayed on the screen. The basic speed of the IBP is 25 mm/s.	6.25mm/s, 12.5mm/s, 25mm/s, 50mm/s
A-3-2. IBP label	Menu to set measuring position ART, FEM, PAP, RAP, LAP, UAP, UVP, CVP, ICP, USERDEFINED	
A-3-3. Scale	Menu to set size of measurement waveform on screen.	30, 60, 80, 100, 160, 200, 300 (in mmHg)
A-3-4. Pulse rate	Menu to set display of blood pressure pulse	
B-1. Zeroing	Menu to set zero-point of transducer. If zero adjustment is not performed, " IMBALANCE " message is displayed in the waveform window.	

Trouble Shooting

Trouble shootings for a case that blood pressure value is not displayed on screen

Description	Action to Take
In case of ' out of measurement range ' situation	Check the measurement conditions.
In case blood pressure transducer is damaged	Replace the damaged transducer with new one

Trouble shootings for a case the measured value is different from the expected value

Description	Action to Take
In case there are air bubbles in tubes	Remove the air bubbles
In case an extension tube is connected	Remove the extension tube
In case of using blood pressure transducer with a different sensitivity	Check position of transducer
For other cases	Perform zero-point adjustment

15. Printer

Overview

The monitor allows the user to print out monitoring data, including trends and alarm data. Recordings of waveforms are either timed or continuous and print at a recording speed of 25mm/s. All recordings are identified by the animal's name, ID as well as the date and time of the recording request. The monitor can trigger alarm recordings automatically for life-threatening alarms and limit violations, if the Record function is enabled on the alarm limits table.

A printer used to print data onto thermal paper: Size of the thermal paper roll: 58mm wide x 38mm in diameter. Any thermal paper of same size can be used for the printer.

Caution	Due to the nature of thermal paper, it generates heat when continuously output, so it is recommended to output after 5 minutes of output and after 10 minutes of idle time.
----------------	--

Printer Settings

Menu	Description	Available settings
A. Print Setup menu		
A-1. Printer setup		
A-1-1. Use of printer	Printer activation	ON / OFF
A-1-2. Printer speed	Printer speed select	25 mm/s 50 mm/s
A-1-3. Waveform1	Channel 1 waveform select	OFF, SPO2, RESP, ETCO2, LEAD I, LEAD II, LEAD III, aVR, aVL, aVF, V, IBP1 ¹⁾ , IBP2 ¹⁾ ,
A-1-4. Waveform2	Channel 2 waveform select	
A-1-5. Waveform3	Channel 3 waveform select	
A-1-6. Print key	In the PRINTER Key menu, press the printer key to set the output point as shown below	Real time Delay (5sec)

	<p>REAL TIME: Prints the data from the point where the PRINTER key was pressed.</p> <p>DELAY: Prints data before 5 seconds when PRINTER key is pressed</p>	
A-1-7. Printing period	Set the time for printing the printout on normal printout. If you do not stop manually after pressing the PRINTER KEY, the output will be output only for the following period of time.	Continue, 10sec, 20sec, 30sec

¹⁾: BM5Vet Elite, BM7Vet Elite only

Note	During printing time, the wave forms of IBP1 ¹⁾, IBP2 ¹⁾, ETCO2 on paper look different from the wave forms on screen. The reason is that the wave forms on screen cannot be scaled, but the wave forms on paper can be scaled.
-------------	--

¹⁾: BM5Vet Elite, BM7Vet Elite only

Thermal Paper Storage

To avoid print quality degradation or attenuation of printouts, follow these precautions:

Note	These precautions apply to both unused paper as well as paper that has already been run through the printer.
-------------	---

- Store in cool, dark locations. Temperature must be below 27°C (80°F). Relative humidity must be between 40% and 65%.
- Avoid exposure to bright light or ultraviolet sources such as sunlight, fluorescent, and similar lighting which causes yellowing of paper and fading of tracings.
- AVOID CONTACT WITH: cleaning fluids and solvents such as alcohols, ketones, esters, ether, etc.
- DO NOT STORE THERMAL PAPER WITH ANY OF THE FOLLOWING:
 - ✓ Carbon and carbonless forms.

- ✓ Non-thermal chart papers or any other products containing tributyl phosphate, dibutyl phthalate, or any other organic solvents. Many medical and industrial charts contain these chemicals.
- ✓ Document protectors, envelopes, and sheet separators containing polyvinyl chloride or other vinyl chlorides.
- DO NOT USE: mounting forms, pressure-sensitive tapes or labels containing solvent-based adhesives.

To assure maximum trace image life, thermal paper should be stored separately in: manilla folders, polyester, or polyimide protectors.

Plastic document protectors, envelopes, or sheet separators made of polystyrene, polypropylene, or polyethylene will not degrade thermal traces in themselves. However, these materials afford no protection against fading from external causes.

Paper manufacturers advise us that these thermal products should retain their traces when properly imaged and stored for about 3-5 years.

If your retention requirements exceed these guidelines, we recommend you consider alternate image storage techniques.

Paper Change

1. Open the window of the printer.
2. Insert the paper roll offered with the product into the printing unit. Place the roll in a proper way so that the printed paper can roll out upwards.
3. Press the printer window until it is properly shut. Improper closing may cause failure in printing.

16. Maintenance and Troubleshooting

Inspection of equipment

You should perform a visual inspection before every use, and in accordance with your hospital's policy. With the monitor switched off:

- Examine unit exteriors for cleanliness and general physical condition. Make sure that the housings are not cracked or broken, that everything is present, that there are no spilled liquids and that there are no signs of abuse.
- If the EtCO₂ and Multi-gas module are mounted on the monitor, make sure that they are locked into place and do not slide out without releasing the locking mechanism.
- Inspect all accessories (cables, transducers, sensors and so forth). If any show signs of damage, do not use.

Switch the monitor on and make sure the backlight is bright enough. Check that screen is at its full brightness. If the brightness is not adequate, contact your service personnel or your supplier

Warning

Use of this equipment adjacent to or stacked with other equipment should be avoided because it could result in improper operation. If such use is necessary, this equipment and the other equipment should be observed to verify that they are operating normally

Inspection of cables

- Examine all system cables, the power plug for damage. Make sure that the prongs of the plug do not move in the adaptor. If damaged, replace it with an appropriate Bionet power cord and adaptor.
- Inspect the parameter cable and ensure that it makes good connection with the Monitor. Make sure that there are no breaks in the insulation.
- Apply the transducer or electrodes to the animal, and with the monitor switched on, flex the Patient cables near each end to make sure that there are no intermittent faults

Warning

To avoid contaminating or infecting personnel, the environment or other equipment, make sure you disinfect and decontaminate the monitor appropriately before disposing of it in accordance with your country's laws for equipment containing electrical and electronic parts. For disposal of parts and accessories such as thermometers, where not otherwise specified, follow local regulations regarding disposal of hospital waste.

Maintenance task and test schedule

All maintenance tasks and performance tests are documented in detail in the service documentation

Maintenance and test schedule	Frequency
Monitor tests	
Safety checks. Selected tests on the basis of IEC 60601-1	At least once every two years, or as needed, after any repairs where the power supply is removed or replaced, or if the monitor has been dropped
Monitor maintenance	
Check ECG synchronization of the monitor and defibrillator (only if hospital protocol requires use of monitor during defibrillation)	At least once every two years, or as needed.
Replace backlight (integrated displays only)	35,000 - 40,000 hours (about four years) of continuous usage, or as needed.
Parameter module tests	
Performance assurance for all measurements not listed below.	At least once every two years, or if you suspect the measurement values are incorrect.
Parameter module maintenance	
NIBP calibration	At least once every two years, or as specified by local laws.
Mainstream and sidestream CO ₂ calibration check	At least once a year, or if you suspect the measurement values are incorrect.
Battery maintenance	
Battery	See this section on Maintaining Batteries in chapter 1.

Trouble shooting

Noise in ECG

Check that the filter settings are appropriate.

Check whether the electrode is attached well.

Check whether the gel on the electrode is dry.

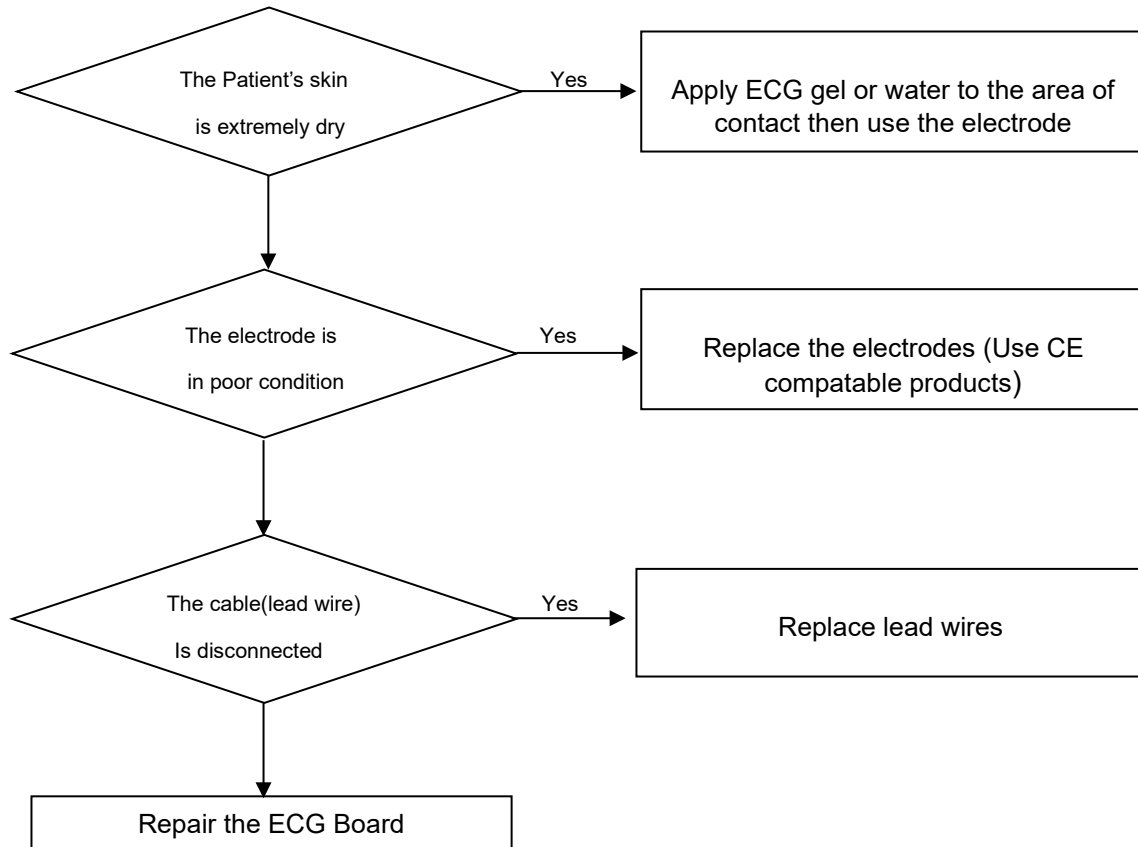

SpO2 malfunction

Check the connectors of the equipment are in poor or broken condition.

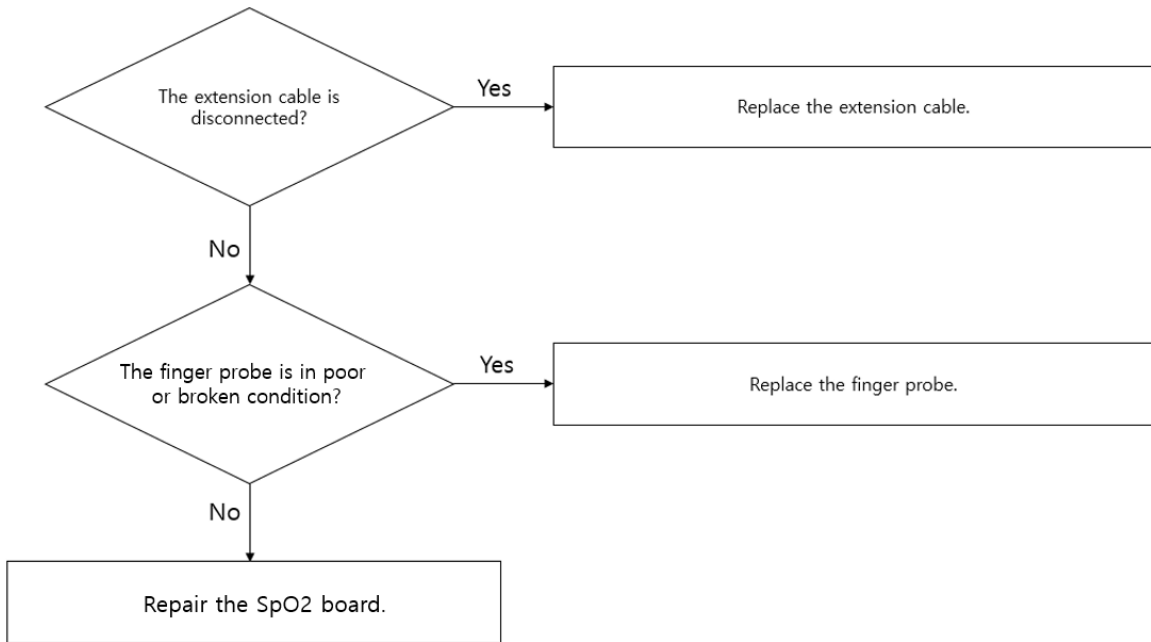

Temperature malfunction

If the temperature cannot be measured, check the connection with the equipment.

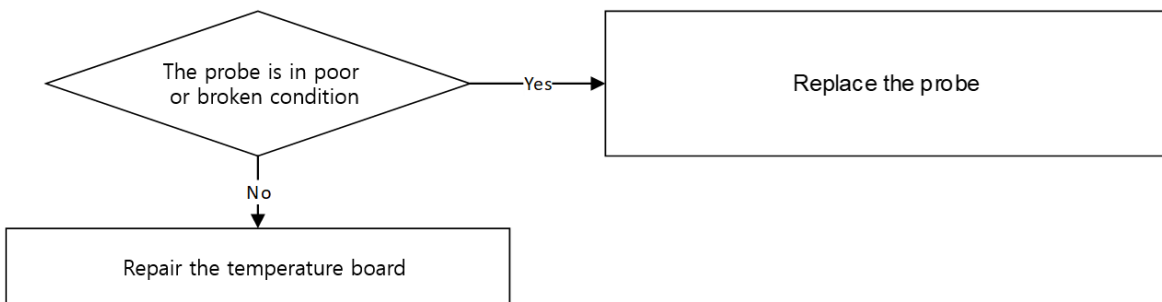

NIBP malfunction

Check connector connection status and confirm that the hose is normally connected

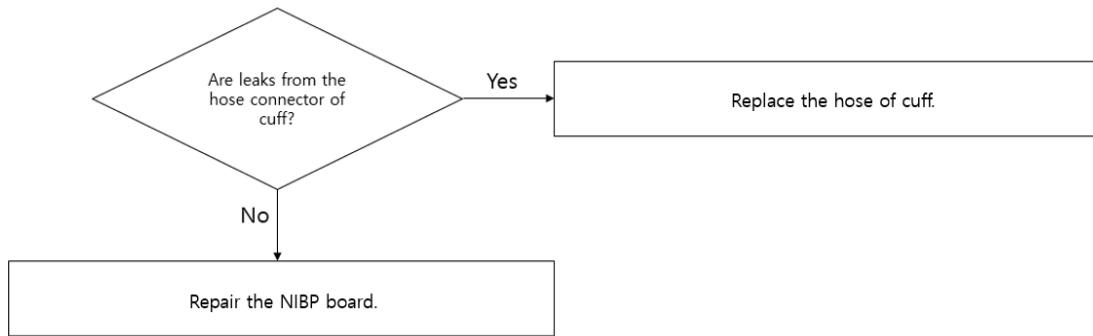

Abnormality in NIBP measurements

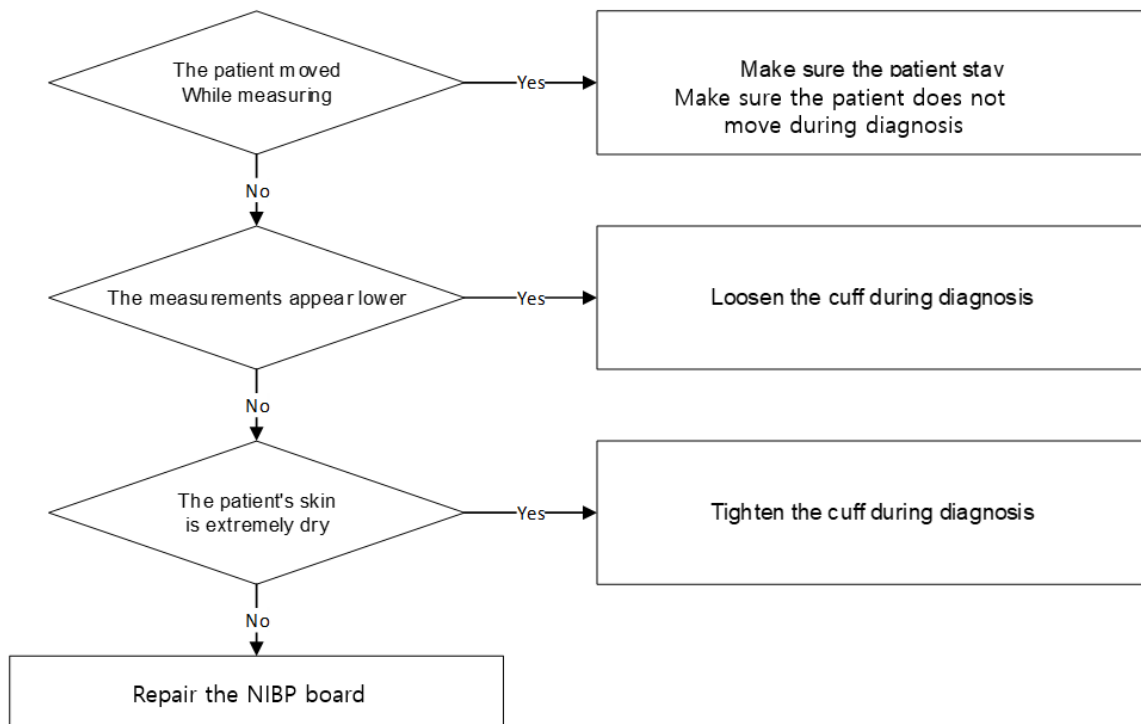

EtCO2 malfunction

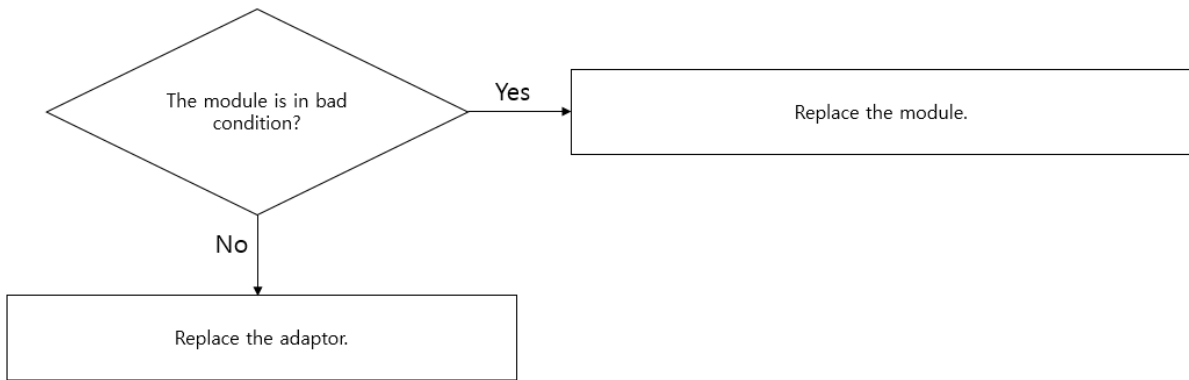

Failure in battery recharge

(In case the battery will not charge in 6 hours or more)

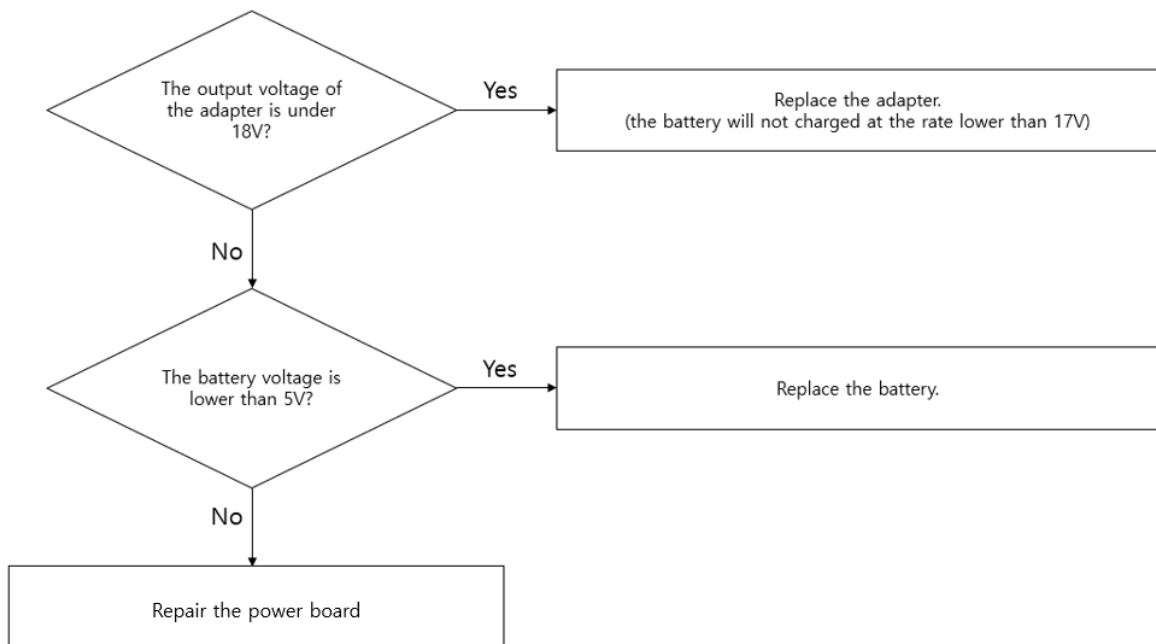

Power failure

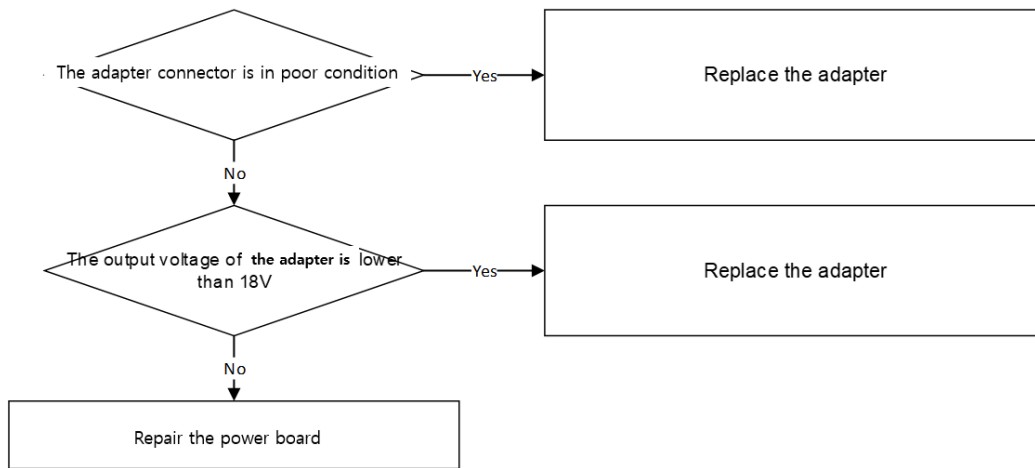

Print failure

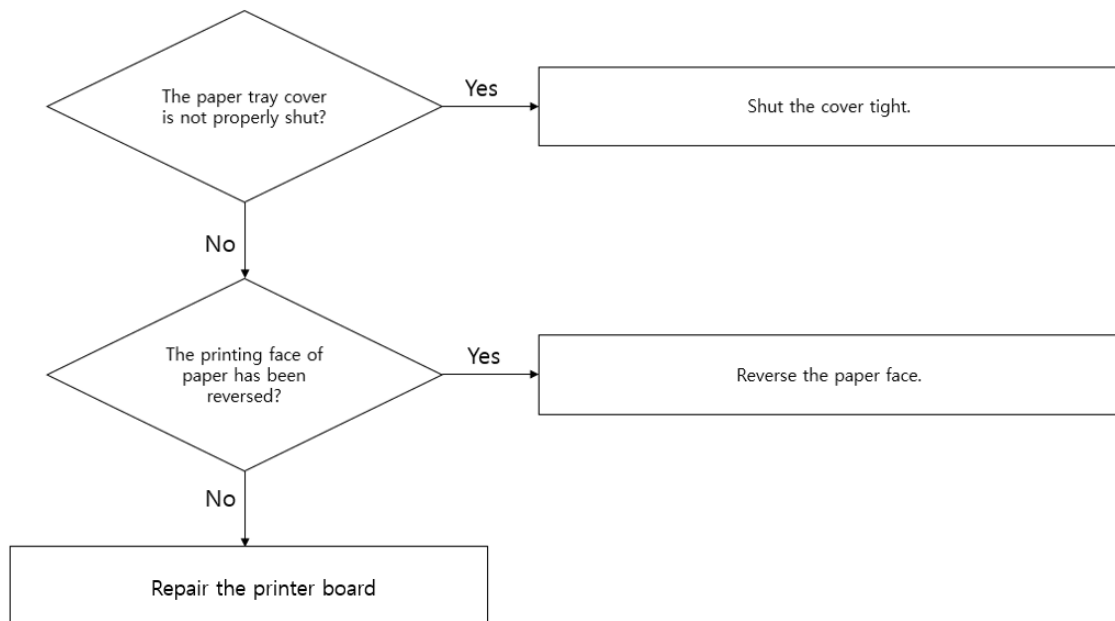

Dual Gas Malfunction

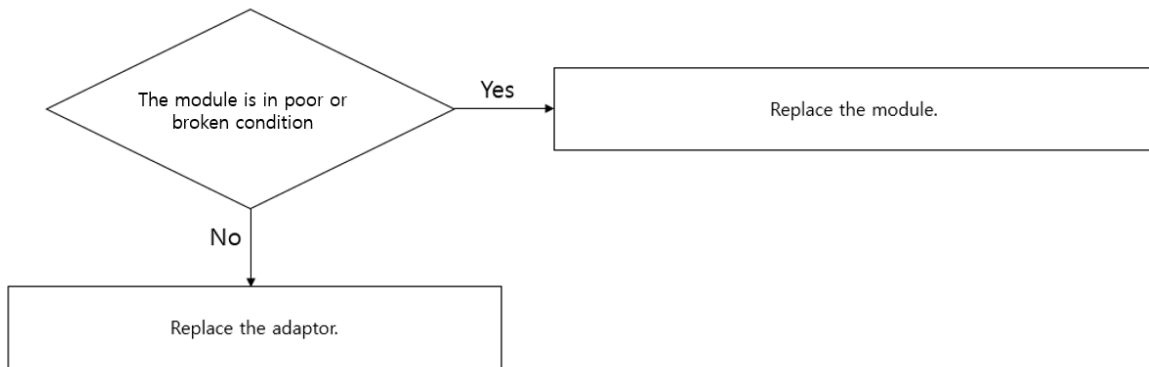

Data storage failure

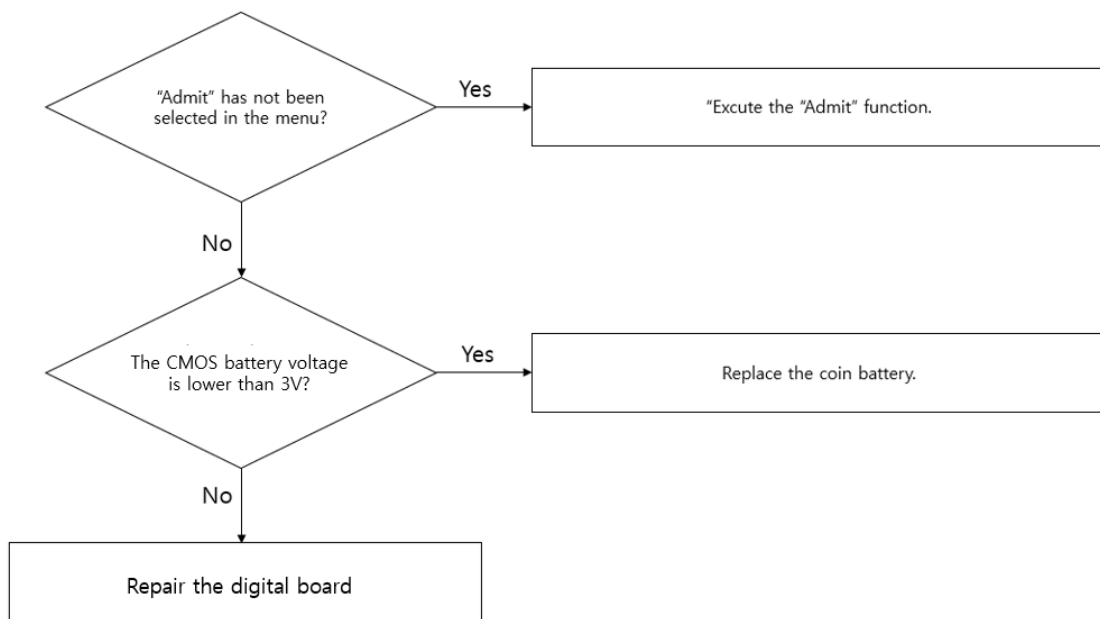

Periodic Noises

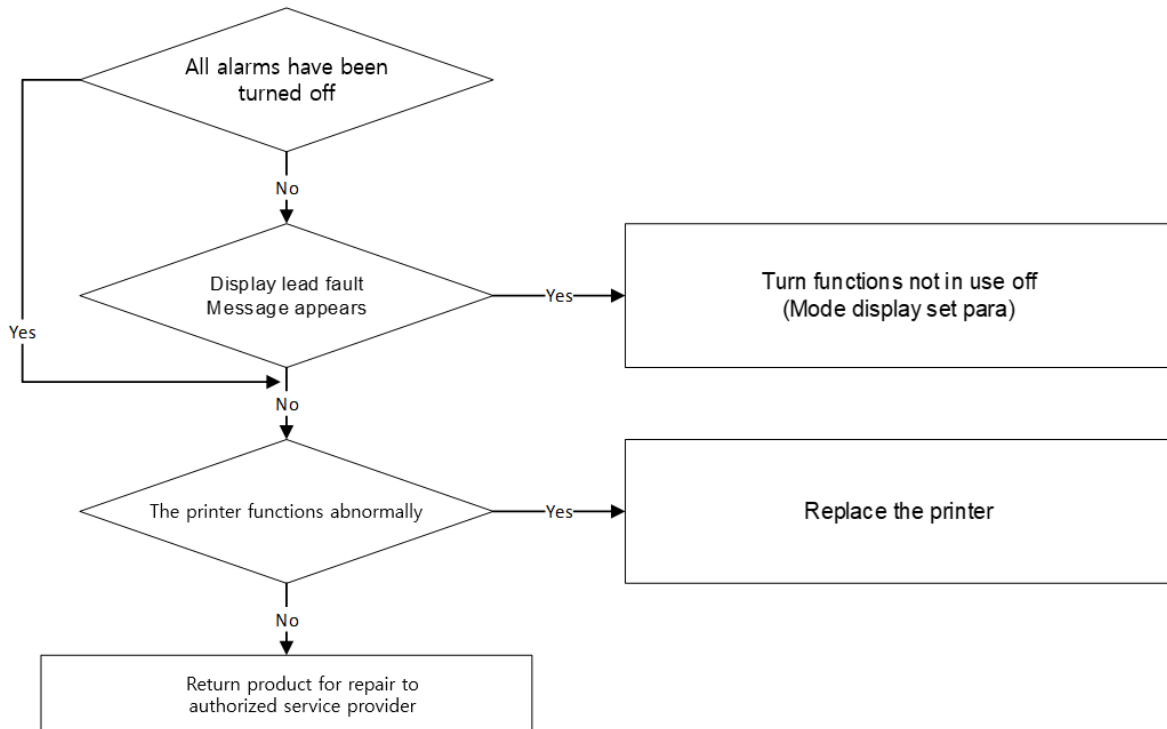

Cyber security issues

1. If the equipment is stolen or lost, immediately report it to the hospital staff or manufacturer. Upon receipt of a report, the hospital network administrator must take measures to prevent the device from accessing the hospital network.
2. If a cyber security threat is detected while using the device, immediately disconnect the device from the network and contact the hospital staff or manufacturer.

※ For manufacturer contact information, please refer to the table of contents of how to contact us.

Storage lifetime issues

If the storage is nearing the end of its life, the following warning message appears when booting the device or hospitalizing the patient.

If the warning message appears, contact the customer center or the purchasing agent to check the equipment.

The storage has expired.
Contact the customer center or the store
where you purchased the product
and inspect the equipment

17. Clean and Care

Overview

Clean the monitor and all accessories after each animal or daily according to your hospital's standard protocol. We recommend the following cleaning solution and procedures. To avoid contamination and unnecessary damage to the equipment, follow the instructions below.

Bionet does not claim the right to the following chemical efficacy, disinfectant method, the ability of the drug to inhibit bacterial infection, environmental impact, safe handling, or precautions related to use. For more information on these topics, see the information provided by the detergent manufacturer.

Monitor, Modules and Accessories

Moisture can damage the monitor and peripherals. (For example, around connectors, EtCO₂ modules).

Please read the following instructions carefully before cleaning the basic unit or peripherals.

The following pages contain precautions for cleaning certain equipment and peripherals.

- Do not spray detergent on the monitor or peripheral devices. Wipe it off with a damp cloth.
- Disinfect the surface with gauze with diluted alcohol.
- Dry thoroughly with a lint-free cloth.

Caution

Do not wet or rinse the monitor and accessories. Disconnect the unit from the power source if you accidentally spilled liquid on the equipment. Contact your technician for stability before operating the equipment.

To prevent damage to the equipment, do not use sharp tools or abrasives. Never immerse the electrical connector in water or other liquids. When cleaning, be careful not to let the liquid stick to the edge of the screen.

Patient's Cable

- Clean the patient cables with a gauze pad moistened with a soap solution.
- To disinfect patient cables, wipe the cables with a gauze moistened with diluted alcohol or a glutaraldehyde-based disinfectant.
- Ethylene oxide is suitable for intensive disinfection (almost sterilization), but it shows that the service life of cables and lead wires is reduced.
- Dry thoroughly with a lint-free cloth.

Caution	<p>Do not use disinfectants that contain phenol as they can spot plastics. Do not autoclave or clean accessories with strong aromatic, chlorinated, ketone, ether, or ester solvents. Never immerse electrical connectors.</p> <p>When cleaning, do not apply excessive pressure or bend the cable unnecessarily. Excessive pressure can damage the cable.</p>
----------------	--

Reusable ECG Electrodes

Clean the electrode cup regularly with a toothbrush. When removing gel-like residues, use a soft brush with flowing water. Wipe the electrode with a soapy cloth moistened with soapy water.

- Sterilize the electrode by soaking the diluted alcohol in cloth.
- Dry thoroughly with a lint-free cloth.

Reusable SpO2 sensor

Clean the SpO2 sensor by wiping it with soapy water soaked gauze. Disinfect the sensor by wiping with 70% alcohol solution. Allow the sensor to dry completely with a lint-free cloth before applying to the animal.

Reusable Temperature probes and cables

Do not use excessive pressure or flex the cables as this can stretch the covering and break the internal wires.

- Clean the probes with a 3% hydrogen peroxide or 70% alcohol.

- Quickly immerse the cables in a detergent solution.
- Make sure the probe's tip is firmly connected.

Capnostat sensor

Wipe the sensor surface and sensor window with a damp cloth. Do not attempt to wet the sensor or disinfect it with hot water. Allow to dry completely with a lint-free cloth. Make sure the sensor window is clean and dry before use.

IBP Transducer (BM5Vet Elite, BM7Vet Elite only)

Handle transducers and other pressure peripherals with care. Do not apply excessive pressure to the conversion board. Do not expose the transducer to water, steam, dry heat sterilization, ether, chloroform, or other similar chemicals. Always protect the connector from water.

Caution	Never boil or autoclave the cable. Vinyl withstands temperatures up to 100°C but begins to soften at around 90°C. Handle gently when hot and wipe away from the tip toward the cable.
----------------	--

Caution	Decisions on disinfection should be made by the user organization in accordance with the integrity of the wires or lead wires.
----------------	---

Note	The equipment should be inspected regularly once a year. For inspection items, refer to the user manual or service manual.
-------------	---

Carefully inspect the main unit and sensor after cleaning the equipment. Do not use damaged or old equipment.

Clean the exterior of the equipment at least once a month using a soft cloth moistened with lukewarm water or alcohol. Do not use lacquers, thinners, ethylene, or oxidizers that could damage the equipment.

Make sure that the cables and accessories are free from dust and dirt, then wipe them with a soft cloth moistened with 40 ° C water. Please wipe it with clinical alcohol at least once a week.

Do not immerse the accessory in liquid or detergent. Also, make sure that no liquid penetrates the instrument or probe.

Caution

**Do not dispose of the disposable probe in a potentially hazardous area.
Always be careful about environmental pollution.**

Caution

**There is a backup battery inside the system.
When disposing of the battery, dispose of it in an appropriate place for environmental protection.**

Warning

When replacing the backup battery, check the battery electrode.

If you suspect the installation or disposition of the external ground wire, operate the equipment by means of the internal power supply.

If the unit is not used for a certain period of time, remove the backup battery so that safety hazards do not occur.

18. Technical Specification

Overview

The monitor is not user installable. It must be installed by qualified service personnel.

The monitor is intended to be used for monitoring, recording, and alarming of multiple physiological parameters of animals in health care facilities. The device is to be used by trained health care professionals.

The monitor is intended for use in health care facilities; the BM3Vet Elite/BM5Vet Elite/BM7Vet Elite Monitor is additionally intended for use in transport situations within the hospital setting.

EMC Compatibility (EMC)

Much of the information below has been borrowed from the requirements set forth in the Electromagnetic Compatibility Standard IEC 60601-1-2 for medical electrical equipment issued by the International Electro technical Commission and is available from a variety of sources. Although primarily aimed at equipment manufacturers, most of the information contained here is useful for users interested in medical equipment.

The information contained in this section (such as separation distance) is generally information about the Bionet Veterinary Multiparameter Monitor detailed above. The numbers provided here are not guaranteed but are provided with reasonable assurance of error-free operation. This information may not apply to other medical and electrical systems, and older equipment may be particularly susceptible to interference.

Note	<p>Medical electrical equipment requires special precautions for electromagnetic compatibility and must be installed and serviced in accordance with the EMC information in this section and in the operating instructions supplied with the monitor.</p> <p>Portable and mobile RF communication equipment can affect medical electrical equipment.</p> <p>Cables and accessories not specified in the user guide are not certified. Using other cables and / or accessories may adversely affect safety, performance, and electromagnetic compatibility (increased electromagnetic emissions and</p>
-------------	---

reduced immunity).

- This equipment should not be used near or on top of other equipment. If you need to use it on its side or stacked, you should observe the equipment to make sure it works properly within your configuration.
- This veterinary multiparameter monitoring device communicates over a 2.4 GHz 802.11b / g wireless network. Other equipment may interfere with data reception on this wireless network. This is also true if the equipment complies with the CISPR emission requirements. When using veterinary multiparameter monitoring equipment to communicate over a wireless network, be sure to check that it is compatible with existing or new wireless systems (eg, cell phones, pager systems, cordless phones, etc.). For example, a Bluetooth-compliant device using the 2.4 GHz frequency band may interfere with the wireless communication of the Veterinary Multiparameter Monitor. For more information on wireless deployment, please contact your Bionet representative.
- Low amplitude signals such as EEG and ECG are particularly sensitive to interference from electromagnetic energy. This equipment complies with the tests listed at the bottom but does not guarantee complete operation. The "quiet" electrical environment is better. In general, the greater the distance between electrical equipment, the lower the likelihood of interference.

Manufacturer’s Declaration - Electromagnetic Emission

The BM3Vet Elite, BM5Vet Elite, BM7Vet Elite system are intended for use in the electromagnetic environment specified below. The customer or the user of BM3Vet Elite, BM5Vet Elite, BM7Vet Elite system should assure that it is used in such an environment.

Emission test		Compliance	Electromagnetic environment - guidance
Mains disturbance CISPR 11	terminal voltage	GROUP1, CLASS A	The EMISSIONS characteristics of BM3Vet Elite, BM5Vet Elite, BM7Vet Elite make it suitable for use in industrial areas and hospitals (CISPR 11

RADIATED DISTURBANCE CISPR 11	GROUP1, CLASS A	class A). If it is used in a residential environment (for which CISPR 11 class B is normally required) BM3Vet Elite, BM5Vet Elite, BM7Vet Elite might not offer adequate protection to radio-frequency communication services. The user might need to take mitigation measures, such as relocating or re-orienting the equipment.
Harmonic Current Emission IEC 61000-3-2	CLASS A	The BM3Vet Elite, BM5Vet Elite, BM7Vet Elite are suitable for use in all establishments other than domestic and may be used in domestic establishments and those directly connected to the public low-voltage power supply network that supplies buildings used for domestic purposes.
Voltage change, Voltage fluctuations and Flicker Emission IEC 61000-3-3	Pst: 1 Plt: 0.65 Tmax: 0.5 dmax: 4% DC: 3.3%	

Manufacturer's Declaration - Electromagnetic Immunity

The BM3Vet Elite, BM5Vet Elite, BM7Vet Elite system are intended for use in the electromagnetic environment specified below. The customer or the user of the BM3Vet Elite, BM5Vet Elite, BM7Vet Elite system should assure that it is used in such an environment			
Immunity test	IEC 60601 Test level	Compliance level	Electromagnetic Environment - guidance
Electrostatic Discharge Immunity (ESD) IEC 61000-4-2	± 8 kV/Contact $\pm 2, \pm 4, \pm 8, \pm 15$ kV/Air	± 8 kV/Contact $\pm 2, \pm 4, \pm 8, \pm 15$ kV/Air	Floors should be wood, concrete, or ceramic tile. If floors are covered with synthetic material, the relative humidity should be at least 30%.

<p>Radiated RF Electromagnetic Field Immunity IEC 61000-4-3</p>	<p>3 V/m 80 MHz - 2.7 GHz 80% AM at 1 kHz</p>	<p>3 V/m 80 MHz - 2.7 GHz 80% AM at 1 kHz</p>	<p>BM3Vet Elite, BM5Vet Elite, BM7Vet Elite are suitable to use in professional healthcare environment.</p> <p>RF communication equipment is used no closer than 30 cm to any part of the BM3Vet Elite, BM5Vet Elite, BM7Vet Elite, including cables specified by Bionet</p>
<p>Immunity to Proximity Fields from RF wireless Communication s Equipment IEC 61000-4-3</p>	<p>28 V/m Max. 3855785 MHz in according to table 9 in IEC 606011-2</p>	<p>28 V/m Max. 3855785 MHz in according to table 9 in IEC 606011-2</p>	<p>Mains power quality should be that of a typical commercial or hospital environment.</p>
<p>Electrical Fast Transient/Burst Immunity IEC 61000-4-4</p>	<p>±2 kV, 100 kHz repetition frequency</p>	<p>±2 kV, 100 kHz repetition frequency</p>	<p>The quality of supplied power should be suitable for general business site or hospital environment.</p>
<p>Surge Immunity IEC 61000-45</p>	<p>Line to Line ±0.5 kV, ±1 kV Line to Ground ±0.5 kV, ±1 kV, ±2 kV</p>	<p>Line to Line ±0.5 kV, ±1 kV Line to Ground ±0.5 kV, ±1 kV, ±2 kV</p>	<p>The quality of supplied power should be suitable for general business site or hospital environment.</p>

Immunity to Conducted Disturbances Induced by RF fields IEC 61000-4-6	3 V 0.15 MHz - 80 MHz 6 V in ISM bands between 0.15 MHz and 80 MHz 80% AM at 1 kHz	3 V 0.15 MHz - 80 MHz 6 V in ISM bands between 0.15 MHz and 80 MHz 80% AM at 1 kHz	The strength of RF field in the frequency range higher than 150 kHz~80 MHz, the strength of the RF field is smaller than 3 V Power
Power Frequency Magnetic Field Immunity IEC 61000-4-8	30 A/m 60 Hz	30 A/m 60 Hz	Power frequency magnetic fields should be at levels characteristic of a typical location in a typical commercial or hospital environment.
Voltage dips IEC 61000-4-11	0% UT: 0.5 cycle At 0°, 45°, 90°, 135°, 180°, 225°, 270° and 315° 0% UT; 1 cycle and 70% UT; 30 cycles Single phase: at 0°	0% UT: 0.5 cycle At 0°, 45°, 90°, 135°, 180°, 225°, 270° and 315° 0% UT: 1 cycle and 70 % UT; 30 cycles Single phase: at 0°	Mains power quality should be that of a typical commercial or hospital environment. If the user of the BM3Vet Elite, BM5Vet Elite, BM7Vet Elite requires continued operation during power mains interruptions, it is recommended that the BM3Vet Elite, BM5Vet Elite, BM7Vet Elite be powered from an uninterruptible power supply or a battery be used with the system power source.

Voltage interruptions IEC 61000-4-11:	0% UT; 300 cycles	0% UT; 300 cycles	
NOTE UT is the a.c. mains voltage prior to application of the test level.			

Note	<p>For Type A Professional ME Equipment intended for use in domestic establishment instructions for use includes a warning:</p> <p>This ME equipment is intended for use by professional healthcare personnel only.</p>
-------------	---

Warning	<p>Portable RF communications equipment (including peripherals such as antenna cables and external antennas) should be used no closer than 30 cm (12 inches) to any part of the [ME EQUIPMENT or ME SYSTEM], including cables specified by the manufacturer</p>
----------------	--

Warning	<p>Use of accessories and cables other than those specified or provided by the manufacturer of this equipment could result in increased electromagnetic emissions or decreased electromagnetic immunity of this equipment and result in improper operation</p>
----------------	---

System Specification

Physical			
Model	BM3Vet Elite	BM5Vet Elite	BM7Vet Elite
Dimension (HxWxD) (mm)	240 x 237 x 176	276 x 262 x 176	324 x 257 x 218
Weight (Kg)	Approx. 3.1	Approx. 4.0	Approx. 4.5
Indicator	3 LED		
Cooling	Air flow		
Power	AC 100-240V (50/60Hz) Adapter 18 V, 2.8 A		
Power consumption	< 50Watts		
Operating Mode	Continuous		

Display	Type	TFT-LCD		
	Resolution	800 x 600	800 x 600	1024 x 768
	Size	8"	10.4"	12.1"
Measurement Parameter	Common	ECG, Heart Rate, Respiration Rate, SpO2, Pulse Rate, Systolic BP, Diastolic BP, Mean BP, , EtCO2, FiCO2, Airway Respiration Rate		
	Option	Temperature x 1	Temperature x 2 IBP x 2	Temperature x 2 IBP x 2
TRACE	Waveforms	4 waveforms: 2*ECG, SpO2, RR or EtCO2	6 waveforms: 2*ECG, SpO2, RR or EtCO2, 2*IBP	6 waveforms: 2*ECG, SpO2, RR or EtCO2, 2*IBP
	Sweep Speed	Sweep speed: 6.25, 12.5, 25, 50 mm/sec		
Indicator		Categorized alarms (3 priority levels), Visual alarm lamp, SpO2 pulse pitch tone, Battery status, External power LED		
Interface		DC input connector: 18VDC, 2.8A LAN port for transferring data Nurse call system connector HDMI output connector USB connector		
Battery		Rechargeable Li-ion battery		
Thermal Printer (option)		Speed: 25, 50mm/sec, Paper width: 58mm		
Data Storage		168hours trends, 20cases of 10sec alarm waveform		
Language		English, French, Spanish, Italian, Germany, Chinese, Russian, Czech, Bulgarian, Portuguese, Romanian, Hungarian, Turkish, Polish		
Environments				
Temperature		Operating: 5 ~ +40 °C (41 ~ 104 °F) Storage: -20 ~ +60 °C (-4 ~ +140 °F)		
Humidity		Operating: 30% ~ 85%, Storage: 10% ~ 95% (Package)		
Operating Altitude		Operating: 525 ~ 795 mmHg (70 ~ 106 kPa) Storage: 375 ~ 795 mmHg (50 ~ 106 kPa)		

ECG	
Lead Type	3-lead, 5-lead
Lead Selection	3-lead : I, II, III 5-lead : I, II, III, aVR, aVL, aVF, V
ECG waveforms	3-lead: 1 channel 5-lead: 1 channel (BM3Vet Elite) 5-lead: 2/7 channels (BM5Vet Elite, BM7Vet Elite)
Heart Rate Range	Horse, dog, puppy, cat: 30 to 300 BPM
Heart Rate Accuracy	± 1 bpm or $\pm 1\%$, whichever is greater
Sweep Speed	6.25, 12.5, 25, 50 mm/sec
Filter	Diagnosis: 0.05Hz ~ 150Hz Monitoring: 0.5 ~ 40 Hz Moderate: 0.5 ~ 25 Hz Maximum: 5 ~ 25 Hz
S-T Segment Detection Range	-2.0 to 2.0 mV
Arrhythmia Analysis	ASYSTOLE, VTACH, VFIB BM5Vet Elite, BM7Vet Elite only: BIGEMINY, ACCVENT, COUPLET, IRREGULAR, PAUSE, PVC, RONT, TRIGEMINY, VBRADY, SHORTRUN
Pacemaker Detection Mode	Indicator on waveform display (user selectable)
Protection	Against electrosurgical interference and defibrillation

Respiration Performance	
Method	Thoracic impedance
Channel Selection	RA-LL BM5Vet Elite, BM7Vet Elite only: RA-LA
Measurement Range	5 – 120 breaths per minute

Accuracy	±1 breath per minute
Apnea Alarm	Yes

SpO2 Performance	
SpO2 Range	0 to 100%
SpO2 Accuracy	70 to 100% ±2 digits 0 to 69% unspecified
Pulse Rate Range	18 to 450 bpm
Pulse Rate Accuracy	±2 bpm

NIBP Performance	
Method	Oscillometry with step deflation
Operation Mode	Manual/Automatic/Continuous
Measurement Range	Systolic: 40 to 260 mmHg MAP: 26 to 220 mmHg Diastolic: 20 to 200 mmHg
Accuracy	Mean error: less than ±5 mmHg Standard deviation: less than 8 mmHg

Temperature Performance	
Measurement Range	0 to 50°C (32°F to 122°F)
Accuracy	25°C to 50°C: ±0.1°C 0°C to 24°C: ±0.2°C
Compatibility	98ME04GA603 temperature probes

Sidestream CO2 (Option)	
Measurement Range	0 to 150 mmHg, 0 to 19%

Accuracy	0-40mmHg ± 2 mmHg, 41-70mmHg $\pm 5\%$ of reading 71-100mmHg $\pm 8\%$ of reading, 101-150mmHg $\pm 10\%$ of reading
Respiration Rate	2 to 150 breaths per minute
Respiration Accuracy	± 1 breath per minute

Mainstream CO2 (Option)	
Measurement Range	0 to 150 mmHg, 0 to 19%
Accuracy	0-40mmHg ± 2 mmHg, 41-70mmHg $\pm 5\%$ of reading 71-100mmHg $\pm 8\%$ of reading, 101-150mmHg $\pm 10\%$ of reading
Respiration Rate	0 to 150 breaths per minute
Respiration Accuracy	± 1 breath per minute
IBP Performance (BM5Vet Elite/BM7Vet Elite Only)	
Channels	2
Measurement Range	-50 to 300mmHg
Accuracy	4 % of reading or ± 4 mmHg, whichever is greater
Pulse Rate Measurement Range	0 to 300bpm
Zero Balancing	Range: ± 200 mmHg Accuracy: ± 1 mmHg Drift: ± 1 mmHg over 24hours
Transducer Sensitivity	5 μ V/V/mmHg

Arrhythmia Alarm Default Level

Type	Arrhythmia	Alarm Level				Alarm On/Off	
		High	Medium	Low	Message	On	Off
OFF	ASYSTOL	●					●
	VTAC	●					●
	VTACVFIB	●					●
	BIGEMINY	●					●
	TRIGEMINY	●					●
	ACCVENT	●					●
	COUPLET	●					●
	IRREGULAR	●					●
	PAUSE	●					●
	RONT	●					●
	VBRADY	●					●
	SHORTRUN	●					●
	PVC	●					●
LETHAL	ASYSTOL	●				●	
	VTAC	●				●	
	VTACVFIB	●				●	
	BIGEMINY	●					●
	TRIGEMINY	●					●
	ACCVENT	●					●
	COUPLET	●					●
	IRREGULAR	●					●
	PAUSE	●					●
	RONT	●					●
	VBRADY	●					●
	SHORTRUN	●					●
	PVC	●					●
FULL	ASYSTOL	●				●	
	VTAC	●				●	
	VTACVFIB	●				●	
	BIGEMINY	●				●	
	TRIGEMINY	●				●	
	ACCVENT	●				●	
	COUPLET	●				●	
	IRREGULAR	●				●	

	PAUSE	●				●	
	RONT	●				●	
	VBRADY	●				●	
	SHORTRUN	●				●	
	PVC	●				●	

Parameter Alarm Default Level

Biosignal Class	Animal Type	Biosignal Alarm		Alarm Level				Alarm On/Off	
		Position (IBP ONLY)	Alarm	High	Medium	Low	Message	On	Off
ECG	PUPPY	HR			●			●	
		ST					●		●
		PVC					●		●
	CAT	HR				●			●
		ST						●	●
		PVC					●		●
	DOG	HR				●			●
		ST						●	●
		PVC					●		●
	HORSE	HR				●			●
		ST						●	●
		PVC					●		●
SPO2	PUPPY	SPO2						●	
		SPO2-RATE						●	
	CAT	SPO2						●	
		SPO2-RATE						●	
	DOG	SPO2						●	
		SPO2-RATE						●	
HORSE	SPO2						●		
	SPO2-RATE						●		
RESP	PUPPY	RR						●	
		RR-APNEA						●	
	CAT	RR						●	
		RR-APNEA						●	

	DOG	RR			●		●	
		RR-APNEA			●		●	
	HORSE	RR			●		●	
		RR-APNEA			●		●	
NIBP	PUPPY	NIBP-S		●			●	
		NIBP-M		●			●	
		NIBP-D		●			●	
		NIBP-PR			●		●	
	CAT	NIBP-S		●			●	
		NIBP-M		●			●	
		NIBP-D		●			●	
		NIBP-PR			●		●	
	DOG	NIBP-S		●			●	
		NIBP-M		●			●	
		NIBP-D		●			●	
		NIBP-PR			●		●	
	HORSE	NIBP-S		●			●	
		NIBP-M		●			●	
		NIBP-D		●			●	
		NIBP-PR			●		●	
TEMP	PUPPY	T-1			●		●	
		T-2			●		●	
		T-DT			●		●	
	CAT	T-1			●		●	
		T-2			●		●	
		T-DT			●		●	
	DOG	T-1			●		●	
		T-2			●		●	
		T-DT			●		●	
	HORSE	T-1			●		●	
		T-2			●		●	
		T-DT			●		●	
IBP	PUPPY	ART	IBP-S			●		●
			IBP-M			●		●
			IBP-D			●		●
			IBP-PR			●		●
	FEM	IBP-S			●		●	
		IBP-M			●		●	

	CAT		IBP-D			●		●	
			IBP-PR			●		●	
		PAP	IBP-S			●		●	
			IBP-M			●		●	
			IBP-D			●		●	
			IBP-PR			●		●	
			RAP (M-ONLY)	IBP-S			●		
		IBP-M				●		●	
		IBP-D				●			●
		IBP-PR				●			●
		LAP (M-ONLY)	IBP-S			●			●
			IBP-M			●		●	
			IBP-D			●			●
			IBP-PR			●			●
		UAP	IBP-S			●		●	
			IBP-M			●		●	
			IBP-D			●		●	
			IBP-PR			●			●
		UVP (M-ONLY)	IBP-S			●			●
			IBP-M			●		●	
			IBP-D			●			●
			IBP-PR			●			●
		CVP (M-ONLY)	IBP-S			●			●
			IBP-M			●		●	
			IBP-D			●			●
			IBP-PR			●			●
		ICP (M-ONLY)	IBP-S			●			●
			IBP-M			●		●	
			IBP-D			●			●
			IBP-PR			●			●
		USER	IBP-S			●		●	
			IBP-M			●		●	
			IBP-D			●		●	
			IBP-PR			●			●
		ART	IBP-S			●		●	
			IBP-M			●		●	
	IBP-D				●		●		
	IBP-PR				●		●		

		FEM	IBP-S			●		●	
			IBP-M			●		●	
			IBP-D			●		●	
			IBP-PR			●		●	
		PAP	IBP-S			●		●	
			IBP-M			●		●	
			IBP-D			●		●	
			IBP-PR			●		●	
		RAP (M-ONLY)	IBP-S			●			●
			IBP-M			●		●	
			IBP-D			●			●
			IBP-PR			●			●
		LAP (M-ONLY)	IBP-S			●			●
			IBP-M			●		●	
			IBP-D			●			●
			IBP-PR			●			●
		UAP	IBP-S			●		●	
			IBP-M			●		●	
			IBP-D			●		●	
			IBP-PR			●			●
		UVP (M-ONLY)	IBP-S			●			●
			IBP-M			●		●	
			IBP-D			●			●
			IBP-PR			●			●
		CVP (M-ONLY)	IBP-S			●			●
			IBP-M			●		●	
			IBP-D			●			●
			IBP-PR			●			●
		ICP (M-ONLY)	IBP-S			●			●
			IBP-M			●		●	
			IBP-D			●			●
			IBP-PR			●			●
		USER	IBP-S			●		●	
			IBP-M			●		●	
			IBP-D			●		●	
			IBP-PR			●			●
	DOG	ART	IBP-S			●		●	
			IBP-M			●		●	

			IBP-D			●		●	
			IBP-PR			●		●	
		FEM	IBP-S			●		●	
			IBP-M			●		●	
			IBP-D			●		●	
			IBP-PR			●		●	
		PAP	IBP-S			●		●	
			IBP-M			●		●	
			IBP-D			●		●	
			IBP-PR			●		●	
		RAP (M-ONLY)	IBP-S			●			●
			IBP-M			●		●	
			IBP-D			●			●
			IBP-PR			●			●
		LAP (M-ONLY)	IBP-S			●			●
			IBP-M			●		●	
			IBP-D			●			●
			IBP-PR			●			●
		UAP	IBP-S			●		●	
			IBP-M			●		●	
			IBP-D			●		●	
			IBP-PR			●			●
		UVP (M-ONLY)	IBP-S			●			●
			IBP-M			●		●	
			IBP-D			●			●
			IBP-PR			●			●
		CVP (M-ONLY)	IBP-S			●			●
			IBP-M			●		●	
			IBP-D			●			●
			IBP-PR			●			●
		ICP (M-ONLY)	IBP-S			●			●
			IBP-M			●		●	
			IBP-D			●			●
			IBP-PR			●			●
		USER	IBP-S			●		●	
			IBP-M			●		●	
			IBP-D			●		●	
			IBP-PR			●			●

HORSE		ART	IBP-S			●		●	
			IBP-M			●		●	
			IBP-D			●		●	
			IBP-PR			●		●	
		FEM	IBP-S			●		●	
			IBP-M			●		●	
			IBP-D			●		●	
			IBP-PR			●		●	
		PAP	IBP-S			●		●	
			IBP-M			●		●	
			IBP-D			●		●	
			IBP-PR			●		●	
		RAP (M-ONLY)	IBP-S			●			●
			IBP-M			●		●	
			IBP-D			●			●
			IBP-PR			●			●
		LAP (M-ONLY)	IBP-S			●			●
			IBP-M			●		●	
			IBP-D			●			●
			IBP-PR			●			●
		UAP	IBP-S			●		●	
			IBP-M			●		●	
			IBP-D			●		●	
			IBP-PR			●			●
		UVP (M-ONLY)	IBP-S			●			●
			IBP-M			●		●	
			IBP-D			●			●
			IBP-PR			●			●
		CVP (M-ONLY)	IBP-S			●			●
			IBP-M			●		●	
			IBP-D			●			●
			IBP-PR			●			●
		ICP (M-ONLY)	IBP-S			●			●
			IBP-M			●		●	
			IBP-D			●			●
			IBP-PR			●			●
		USER	IBP-S			●		●	
			IBP-M			●		●	

			IBP-D			●		●	
			IBP-PR			●			●
ETCO2	PUPPY	ETCO2				●		●	
		FICO2				●		●	
		AWRR				●		●	
		APNEA				●		●	
	CAT	ETCO2				●		●	
		FICO2				●		●	
		AWRR				●		●	
		APNEA				●		●	
	DOG	ETCO2				●		●	
		FICO2				●		●	
		AWRR				●		●	
		APNEA				●		●	
	HORSE	ETCO2				●		●	
		FICO2				●		●	
		AWRR				●		●	
		APNEA				●		●	
MULTI/ DUAL GAS	PUPPY	ETCO2				●		●	
		FICO2				●		●	
		AWRR				●		●	
		APNEA				●		●	
		N2OE				●		●	
		N2OI				●		●	
		O2E				●			●
		O2I	●					●	
		AG1E-DES		●					●
		AG1I-DES		●					●
		AG1E-ENF		●					●
		AG1I-ENF		●					●
		AG1E-HAL		●					●
		AG1I-HAL		●					●
		AG1E-ISO		●					●
		AG1I-ISO		●					●
		AG1E-SEV		●					●
		AG1I-SEV		●					●
AG2E-DES				●			●		
AG2I-DES				●			●		

		AG2E-ENF			●		●
		AG2I-ENF			●		●
		AG2E-HAL			●		●
		AG2I-HAL			●		●
		AG2E-ISO			●		●
		AG2I-ISO			●		●
		AG2E-SEV			●		●
		AG2I-SEV			●		●
	CAT	ETCO2			●		●
		FICO2			●		●
		AWRR			●		●
		APNEA			●		●
		N2OE			●		●
		N2OI			●		●
		O2E			●		●
		O2I	●				●
		AG1E-DES		●			●
		AG1I-DES		●			●
		AG1E-ENF		●			●
		AG1I-ENF		●			●
		AG1E-HAL		●			●
		AG1I-HAL		●			●
		AG1E-ISO		●			●
		AG1I-ISO		●			●
		AG1E-SEV		●			●
		AG1I-SEV		●			●
		AG2E-DES			●		●
		AG2I-DES			●		●
		AG2E-ENF			●		●
		AG2I-ENF			●		●
		AG2E-HAL			●		●
		AG2I-HAL			●		●
		AG2E-ISO			●		●
AG2I-ISO				●		●	
AG2E-SEV				●		●	
AG2I-SEV			●		●		
DOG	ETCO2			●		●	
	FICO2			●		●	

		AWRR			●		●	
		APNEA			●		●	
		N2OE			●		●	
		N2OI			●		●	
		O2E			●			●
		O2I	●				●	
		AG1E-DES		●				●
		AG1I-DES		●				●
		AG1E-ENF		●				●
		AG1I-ENF		●				●
		AG1E-HAL		●				●
		AG1I-HAL		●				●
		AG1E-ISO		●				●
		AG1I-ISO		●				●
		AG1E-SEV		●				●
		AG1I-SEV		●				●
		AG2E-DES			●			●
		AG2I-DES			●			●
		AG2E-ENF			●			●
		AG2I-ENF			●			●
		AG2E-HAL			●			●
		AG2I-HAL			●			●
		AG2E-ISO			●			●
		AG2I-ISO			●			●
		AG2E-SEV			●			●
		AG2I-SEV			●			●
	HORSE	ETCO2			●		●	
		FICO2			●		●	
		AWRR			●		●	
		APNEA			●		●	
		N2OE			●		●	
		N2OI			●		●	
		O2E			●			●
		O2I	●				●	
		AG1E-DES		●				●
		AG1I-DES		●				●
		AG1E-ENF		●				●
		AG1I-ENF		●				●

		AG1E-HAL		●			●
		AG1I-HAL		●			●
		AG1E-ISO		●			●
		AG1I-ISO		●			●
		AG1E-SEV		●			●
		AG1I-SEV		●			●
		AG2E-DES			●		●
		AG2I-DES			●		●
		AG2E-ENF			●		●
		AG2I-ENF			●		●
		AG2E-HAL			●		●
		AG2I-HAL			●		●
		AG2E-ISO			●		●
		AG2I-ISO			●		●
		AG2E-SEV			●		●
		AG2I-SEV			●		●

Parameter Alarm Default Setting Value and Setting Range

Biosignal Class	Animal Type	Biosignal Alarm		Limits		Min./Max.	
		Position (IBP ONLY)	Alarm	Lower	Upper	Min.	Max.
ECG	PUPPY	HR		90.0	180.0	15.0	350.0
		ST		-0.4	0.4	-2.0	2.0
		PVC		0.0	2.0	0.0	99.0
	CAT	HR		90.0	200.0	15.0	300.0
		ST		-0.4	0.4	-2.0	2.0
		PVC		0.0	2.0	0.0	99.0
	DOG	HR		60.0	150.0	15.0	300.0
		ST		-0.4	0.4	-2.0	2.0
		PVC		0.0	2.0	0.0	99.0
	HORSE	HR		60.0	150.0	15.0	300.0

		ST	-0.4	0.4	-2.0	2.0
		PVC	0.0	20.0	0.0	99.0
SPO2	PUPPY	SPO2	94.0	100.0	0.0	100.0
		SPO2-RATE	90.0	180.0	20.0	250.0
	CAT	SPO2	94.0	100.0	0.0	100.0
		SPO2-RATE	90.0	200.0	20.0	250.0
	DOG	SPO2	94.0	100.0	0.0	100.0
		SPO2-RATE	60.0	150.0	20.0	250.0
	HORSE	SPO2	90.0	100.0	0.0	100.0
		SPO2-RATE	60.0	150.0	20.0	250.0
RESP	PUPPY	RR	10.0	30.0	4.0	150.0
		RR-APNEA	0.0	40.0	0.0	40.0
	CAT	RR	10.0	30.0	4.0	150.0
		RR-APNEA	0.0	40.0	0.0	40.0
	DOG	RR	10.0	30.0	4.0	150.0
		RR-APNEA	0.0	40.0	0.0	40.0
	HORSE	RR	15.0	100.0	4.0	150.0
		RR-APNEA	0.0	20.0	0.0	30.0
NIBP	PUPPY	NIBP-S	80.0	200.0	10.0	350.0
		NIBP-M	70.0	170.0	10.0	350.0
		NIBP-D	40.0	150.0	10.0	350.0
		NIBP-PR	90.0	180.0	20.0	300.0
	CAT	NIBP-S	80.0	200.0	10.0	350.0
		NIBP-M	70.0	170.0	10.0	350.0
		NIBP-D	40.0	150.0	10.0	350.0
		NIBP-PR	90.0	200.0	20.0	300.0
	DOG	NIBP-S	80.0	200.0	10.0	350.0
		NIBP-M	70.0	140.0	10.0	350.0
		NIBP-D	40.0	120.0	10.0	350.0
		NIBP-PR	60.0	150.0	20.0	300.0
	HORSE	NIBP-S	80.0	200.0	10.0	350.0
		NIBP-M	50.0	170.0	10.0	350.0
		NIBP-D	30.0	150.0	10.0	350.0
		NIBP-PR	60.0	150.0	20.0	300.0

TEMP	PUPPY	T-1	36.0	39.4	0.0	50.0	
		T-2	36.0	39.4	0.0	50.0	
		T-DT	0.0	3.4	0.0	50.0	
	CAT	T-1	36.0	39.4	0.0	50.0	
		T-2	36.0	39.4	0.0	50.0	
		T-DT	0.0	3.4	0.0	50.0	
	DOG	T-1	36.0	39.4	0.0	50.0	
		T-2	36.0	39.4	0.0	50.0	
		T-DT	0.0	3.4	0.0	50.0	
	HORSE	T-1	30.0	41.7	0.0	50.0	
		T-2	30.0	41.7	0.0	50.0	
		T-DT	0.0	11.7	0.0	50.0	
IBP	PUPPY	ART	IBP-S	40.0	100.0	-50.0	300.0
			IBP-M	30.0	70.0	-50.0	300.0
			IBP-D	20.0	60.0	-50.0	300.0
			IBP-PR	50.0	170.0	20.0	300.0
		FEM	IBP-S	40.0	100.0	-50.0	300.0
			IBP-M	30.0	70.0	-50.0	300.0
			IBP-D	20.0	50.0	-50.0	300.0
			IBP-PR	50.0	170.0	20.0	300.0
		PAP	IBP-S	40.0	100.0	-50.0	300.0
			IBP-M	30.0	70.0	-50.0	300.0
			IBP-D	20.0	50.0	-50.0	300.0
			IBP-PR	50.0	170.0	20.0	300.0
	RAP (M-ONLY)	IBP-S	0.0	300.0	-50.0	300.0	
		IBP-M	3.0	15.0	-50.0	300.0	
		IBP-D	0.0	300.0	-50.0	300.0	
		IBP-PR	50.0	170.0	20.0	300.0	
		IBP-S	0.0	300.0	-50.0	300.0	
		IBP-M	3.0	15.0	-50.0	300.0	

		LAP (M-ONLY)	IBP-D	0.0	300.0	-50.0	300.0
			IBP-PR	50.0	170.0	20.0	300.0
		UAP	IBP-S	40.0	100.0	-50.0	300.0
			IBP-M	30.0	70.0	-50.0	300.0
			IBP-D	20.0	50.0	-50.0	300.0
			IBP-PR	50.0	170.0	20.0	300.0
		UVP (M-ONLY)	IBP-S	0.0	300.0	-50.0	300.0
			IBP-M	3.0	15.0	-50.0	300.0
			IBP-D	0.0	300.0	-50.0	300.0
			IBP-PR	50.0	170.0	20.0	300.0
		CVP (M-ONLY)	IBP-S	0.0	300.0	-50.0	300.0
			IBP-M	3.0	15.0	-50.0	300.0
			IBP-D	0.0	300.0	-50.0	300.0
			IBP-PR	50.0	170.0	20.0	300.0
		ICP (M-ONLY)	IBP-S	0.0	300.0	-50.0	300.0
			IBP-M	3.0	15.0	-50.0	300.0
			IBP-D	0.0	300.0	-50.0	300.0
			IBP-PR	50.0	170.0	20.0	300.0
		USER	IBP-S	40.0	100.0	-50.0	300.0
			IBP-M	30.0	70.0	-50.0	300.0
			IBP-D	20.0	60.0	-50.0	300.0
			IBP-PR	50.0	170.0	20.0	300.0
		ART	IBP-S	40.0	100.0	-50.0	300.0
			IBP-M	30.0	70.0	-50.0	300.0
			IBP-D	20.0	60.0	-50.0	300.0
			IBP-PR	50.0	170.0	20.0	300.0
		FEM	IBP-S	70.0	150.0	-50.0	300.0
			IBP-M	50.0	115.0	-50.0	300.0

			IBP-D	40.0	100.0	-50.0	300.0
			IBP-PR	50.0	150.0	20.0	300.0
		PAP	IBP-S	20.0	50.0	-50.0	300.0
			IBP-M	10.0	40.0	-50.0	300.0
			IBP-D	5.0	30.0	-50.0	300.0
			IBP-PR	50.0	150.0	20.0	300.0
		RAP (M-ONLY)	IBP-S	0.0	300.0	-50.0	300.0
			IBP-M	3.0	15.0	-50.0	300.0
			IBP-D	0.0	300.0	-50.0	300.0
			IBP-PR	50.0	170.0	20.0	300.0
		LAP (M-ONLY)	IBP-S	0.0	300.0	-50.0	300.0
			IBP-M	3.0	15.0	-50.0	300.0
			IBP-D	0.0	300.0	-50.0	300.0
			IBP-PR	50.0	170.0	20.0	300.0
		UAP	IBP-S	70.0	150.0	-50.0	300.0
			IBP-M	50.0	115.0	-50.0	300.0
			IBP-D	40.0	100.0	-50.0	300.0
			IBP-PR	50.0	150.0	20.0	300.0
		UVP (M-ONLY)	IBP-S	0.0	300.0	-50.0	300.0
			IBP-M	3.0	15.0	-50.0	300.0
			IBP-D	0.0	300.0	-50.0	300.0
			IBP-PR	50.0	170.0	20.0	300.0
		CVP (M-ONLY)	IBP-S	0.0	300.0	-50.0	300.0
			IBP-M	3.0	15.0	-50.0	300.0
			IBP-D	0.0	300.0	-50.0	300.0
			IBP-PR	50.0	170.0	20.0	300.0
			IBP-S	0.0	300.0	-50.0	300.0
			IBP-M	3.0	15.0	-50.0	300.0

		ICP (M- ONLY)	IBP-D	0.0	300.0	-50.0	300.0
			IBP- PR	50.0	170.0	20.0	300.0
		USER	IBP-S	40.0	100.0	-50.0	300.0
			IBP-M	30.0	70.0	-50.0	300.0
			IBP-D	20.0	60.0	-50.0	300.0
			IBP- PR	50.0	170.0	20.0	300.0
		ART	IBP-S	60.0	140.0	-50.0	300.0
			IBP-M	40.0	100.0	-50.0	300.0
	IBP-D		30.0	90.0	-50.0	300.0	
	IBP- PR		50.0	160.0	20.0	300.0	
	FEM	IBP-S	70.0	150.0	-50.0	300.0	
		IBP-M	50.0	115.0	-50.0	300.0	
		IBP-D	40.0	100.0	-50.0	300.0	
		IBP- PR	50.0	150.0	20.0	300.0	
	PAP	IBP-S	20.0	50.0	-50.0	300.0	
		IBP-M	10.0	40.0	-50.0	300.0	
		IBP-D	5.0	30.0	-50.0	300.0	
		IBP- PR	50.0	150.0	20.0	300.0	
	RAP (M- ONLY)	IBP-S	0.0	300.0	-50.0	300.0	
		IBP-M	3.0	15.0	-50.0	300.0	
		IBP-D	0.0	300.0	-50.0	300.0	
		IBP- PR	50.0	170.0	20.0	300.0	
	LAP (M- ONLY)	IBP-S	0.0	300.0	-50.0	300.0	
		IBP-M	3.0	15.0	-50.0	300.0	
IBP-D		0.0	300.0	-50.0	300.0		
IBP- PR		50.0	170.0	20.0	300.0		
UAP	IBP-S	70.0	150.0	-50.0	300.0		
	IBP-M	50.0	115.0	-50.0	300.0		

			IBP-D	40.0	100.0	-50.0	300.0
			IBP-PR	50.0	150.0	20.0	300.0
		UVP (M-ONLY)	IBP-S	0.0	300.0	-50.0	300.0
			IBP-M	3.0	15.0	-50.0	300.0
			IBP-D	0.0	300.0	-50.0	300.0
			IBP-PR	50.0	170.0	20.0	300.0
		CVP (M-ONLY)	IBP-S	0.0	300.0	-50.0	300.0
			IBP-M	3.0	15.0	-50.0	300.0
			IBP-D	0.0	300.0	-50.0	300.0
			IBP-PR	50.0	150.0	20.0	300.0
		ICP (M-ONLY)	IBP-S	0.0	300.0	-50.0	300.0
			IBP-M	3.0	15.0	-50.0	300.0
			IBP-D	0.0	300.0	-50.0	300.0
			IBP-PR	50.0	170.0	20.0	300.0
		USER	IBP-S	60.0	140.0	-50.0	300.0
			IBP-M	40.0	100.0	-50.0	300.0
	IBP-D		30.0	90.0	-50.0	300.0	
	IBP-PR		50.0	160.0	20.0	300.0	
	HORSE	ART	IBP-S	80.0	200.0	-50.0	300.0
			IBP-M	40.0	140.0	-50.0	300.0
			IBP-D	20.0	120.0	-50.0	300.0
			IBP-PR	50.0	150.0	20.0	300.0
		FEM	IBP-S	70.0	150.0	-50.0	300.0
			IBP-M	50.0	115.0	-50.0	300.0
			IBP-D	40.0	100.0	-50.0	300.0
			IBP-PR	50.0	150.0	20.0	300.0
		PAP	IBP-S	20.0	50.0	-50.0	300.0
			IBP-M	10.0	40.0	-50.0	300.0

			IBP-D	5.0	30.0	-50.0	300.0
			IBP-PR	50.0	150.0	20.0	300.0
		RAP (M-ONLY)	IBP-S	0.0	300.0	-50.0	300.0
			IBP-M	3.0	15.0	-50.0	300.0
			IBP-D	0.0	300.0	-50.0	300.0
			IBP-PR	50.0	170.0	20.0	300.0
		LAP (M-ONLY)	IBP-S	0.0	300.0	-50.0	300.0
			IBP-M	3.0	15.0	-50.0	300.0
			IBP-D	0.0	300.0	-50.0	300.0
			IBP-PR	50.0	170.0	20.0	300.0
		UAP	IBP-S	70.0	150.0	-50.0	300.0
			IBP-M	50.0	115.0	-50.0	300.0
			IBP-D	40.0	100.0	-50.0	300.0
			IBP-PR	50.0	150.0	20.0	300.0
		UVP (M-ONLY)	IBP-S	0.0	300.0	-50.0	300.0
			IBP-M	3.0	15.0	-50.0	300.0
			IBP-D	0.0	300.0	-50.0	300.0
			IBP-PR	50.0	170.0	20.0	300.0
		CVP (M-ONLY)	IBP-S	0.0	300.0	-50.0	300.0
			IBP-M	3.0	15.0	-50.0	300.0
IBP-D	0.0		300.0	-50.0	300.0		
IBP-PR	50.0		150.0	20.0	300.0		
ICP (M-ONLY)	IBP-S	0.0	300.0	-50.0	300.0		
	IBP-M	3.0	15.0	-50.0	300.0		
	IBP-D	0.0	300.0	-50.0	300.0		
	IBP-PR	50.0	170.0	20.0	300.0		
USER	IBP-S	80.0	200.0	-50.0	300.0		
	IBP-M	40.0	140.0	-50.0	300.0		

			IBP-D	20.0	120.0	-50.0	300.0
			IBP-PR	50.0	150.0	20.0	300.0
ETCO2	PUPPY	ETCO2		25.0	50.0	0.0	100.0
		FICO2		0.0	5.0	0.0	20.0
		AWRR		10.0	30.0	0.0	150.0
		APNEA		0.0	40.0	10.0	60.0
	CAT	ETCO2		25.0	50.0	0.0	100.0
		FICO2		0.0	5.0	0.0	20.0
		AWRR		10.0	30.0	0.0	150.0
		APNEA		0.0	40.0	10.0	60.0
	DOG	ETCO2		25.0	50.0	0.0	100.0
		FICO2		0.0	5.0	0.0	20.0
		AWRR		10.0	30.0	0.0	150.0
		APNEA		0.0	40.0	10.0	60.0
	HORSE	ETCO2		25.0	50.0	0.0	100.0
		FICO2		0.0	5.0	0.0	20.0
		AWRR		10.0	30.0	0.0	150.0
		APNEA		10.0	20.0	10.0	60.0
MULTI/ DUAL GAS	PUPPY	ETCO2		25.0	50.0	0.0	244.0
		FICO2		0.0	5.0	0.0	244.0
		AWRR		10.0	30.0	0.0	150.0
		APNEA		20.0	40.0	20.0	60.0
		N2OE		0.0	100.0	0.0	1122.0
		N2OI		0.0	82.0	0.0	1122.0
		O2E		10.0	100.0	0.0	1122.0
		O2I		18.0	100.0	0.0	1122.0
		AG1E-DES		0.0	20.0	0.0	244.0
		AG1I-DES		0.0	20.0	0.0	244.0
		AG1E-ENF		0.0	6.0	0.0	244.0
		AG1I-ENF		0.0	6.0	0.0	244.0
		AG1E-HAL		0.0	6.0	0.0	244.0
		AG1I-HAL		0.0	6.0	0.0	244.0
		AG1E-ISO		0.0	6.0	0.0	244.0

		AG1I-ISO	0.0	6.0	0.0	244.0
		AG1E-SEV	0.0	5.0	0.0	244.0
		AG1I-SEV	0.0	5.0	0.0	244.0
		AG2E-DES	0.0	20.0	0.0	244.0
		AG2I-DES	0.0	20.0	0.0	244.0
		AG2E-ENF	0.0	6.0	0.0	244.0
		AG2I-ENF	0.0	6.0	0.0	244.0
		AG2E-HAL	0.0	6.0	0.0	244.0
		AG2I-HAL	0.0	6.0	0.0	244.0
		AG2E-ISO	0.0	6.0	0.0	244.0
		AG2I-ISO	0.0	6.0	0.0	244.0
		AG2E-SEV	0.0	5.0	0.0	244.0
		AG2I-SEV	0.0	5.0	0.0	244.0
	CAT	ETCO2	25.0	50.0	0.0	244.0
		FICO2	0.0	5.0	0.0	244.0
		AWRR	10.0	30.0	0.0	150.0
		APNEA	20.0	40.0	20.0	60.0
		N2OE	0.0	100.0	0.0	1122.0
		N2OI	0.0	82.0	0.0	1122.0
		O2E	10.0	100.0	0.0	1122.0
		O2I	18.0	100.0	0.0	1122.0
		AG1E-DES	0.0	20.0	0.0	244.0
		AG1I-DES	0.0	20.0	0.0	244.0
		AG1E-ENF	0.0	6.0	0.0	244.0
		AG1I-ENF	0.0	6.0	0.0	244.0
		AG1E-HAL	0.0	6.0	0.0	244.0
		AG1I-HAL	0.0	6.0	0.0	244.0
		AG1E-ISO	0.0	6.0	0.0	244.0
		AG1I-ISO	0.0	6.0	0.0	244.0
		AG1E-SEV	0.0	5.0	0.0	244.0
		AG1I-SEV	0.0	5.0	0.0	244.0
		AG2E-DES	0.0	20.0	0.0	244.0
		AG2I-DES	0.0	20.0	0.0	244.0
		AG2E-ENF	0.0	6.0	0.0	244.0

		AG2I-ENF	0.0	6.0	0.0	244.0
		AG2E-HAL	0.0	6.0	0.0	244.0
		AG2I-HAL	0.0	6.0	0.0	244.0
		AG2E-ISO	0.0	6.0	0.0	244.0
		AG2I-ISO	0.0	6.0	0.0	244.0
		AG2E-SEV	0.0	5.0	0.0	244.0
		AG2I-SEV	0.0	5.0	0.0	244.0
	DOG	ETCO2	25.0	50.0	0.0	244.0
		FICO2	0.0	5.0	0.0	244.0
		AWRR	10.0	30.0	0.0	150.0
		APNEA	20.0	40.0	20.0	60.0
		N2OE	0.0	100.0	0.0	1122.0
		N2OI	0.0	82.0	0.0	1122.0
		O2E	10.0	100.0	0.0	1122.0
		O2I	18.0	100.0	0.0	1122.0
		AG1E-DES	0.0	20.0	0.0	244.0
		AG1I-DES	0.0	20.0	0.0	244.0
		AG1E-ENF	0.0	6.0	0.0	244.0
		AG1I-ENF	0.0	6.0	0.0	244.0
		AG1E-HAL	0.0	6.0	0.0	244.0
		AG1I-HAL	0.0	6.0	0.0	244.0
		AG1E-ISO	0.0	6.0	0.0	244.0
		AG1I-ISO	0.0	6.0	0.0	244.0
		AG1E-SEV	0.0	5.0	0.0	244.0
		AG1I-SEV	0.0	5.0	0.0	244.0
		AG2E-DES	0.0	20.0	0.0	244.0
		AG2I-DES	0.0	20.0	0.0	244.0
		AG2E-ENF	0.0	6.0	0.0	244.0
		AG2I-ENF	0.0	6.0	0.0	244.0
		AG2E-HAL	0.0	6.0	0.0	244.0
		AG2I-HAL	0.0	6.0	0.0	244.0
		AG2E-ISO	0.0	6.0	0.0	244.0
		AG2I-ISO	0.0	6.0	0.0	244.0
		AG2E-SEV	0.0	5.0	0.0	244.0

		AG2I-SEV	0.0	5.0	0.0	244.0
	HORSE	ETCO2	25.0	50.0	0.0	244.0
		FICO2	0.0	5.0	0.0	244.0
		AWRR	10.0	30.0	0.0	150.0
		APNEA	20.0	20.0	20.0	60.0
		N2OE	0.0	100.0	0.0	1122.0
		N2OI	0.0	82.0	0.0	1122.0
		O2E	10.0	100.0	0.0	1122.0
		O2I	18.0	100.0	0.0	1122.0
		AG1E-DES	0.0	20.0	0.0	244.0
		AG1I-DES	0.0	20.0	0.0	244.0
		AG1E-ENF	0.0	6.0	0.0	244.0
		AG1I-ENF	0.0	6.0	0.0	244.0
		AG1E-HAL	0.0	6.0	0.0	244.0
		AG1I-HAL	0.0	6.0	0.0	244.0
		AG1E-ISO	0.0	6.0	0.0	244.0
		AG1I-ISO	0.0	6.0	0.0	244.0
		AG1E-SEV	0.0	5.0	0.0	244.0
		AG1I-SEV	0.0	5.0	0.0	244.0
		AG2E-DES	0.0	20.0	0.0	244.0
		AG2I-DES	0.0	20.0	0.0	244.0
		AG2E-ENF	0.0	6.0	0.0	244.0
		AG2I-ENF	0.0	6.0	0.0	244.0
		AG2E-HAL	0.0	6.0	0.0	244.0
		AG2I-HAL	0.0	6.0	0.0	244.0
		AG2E-ISO	0.0	6.0	0.0	244.0
		AG2I-ISO	0.0	6.0	0.0	244.0
		AG2E-SEV	0.0	5.0	0.0	244.0
		AG2I-SEV	0.0	5.0	0.0	244.0

Technical Alarm Default Level

Biosignal Class	Technical Alarm		Alarm Level				Alarm On/Off	
			High	Medium	Low	Message	On	Off
ECG	BM5Vet Elite, BM7Vet Elite Only	CABLEOFF				✓	✓	
	LEADFAULT					✓	✓	
	CHECKELECTRODE					✓	✓	
	HRSEARCH					✓	✓	
SPO2	PROBEOFF					✓	✓	
	CHECKPROBE					✓	✓	
	POORSIGNAL					✓	✓	
	LOSTPULSE					✓	✓	
	ARTIFACT					✓	✓	
	PULSESEARCH					✓	✓	
RESP	CABLEOFF					✓	✓	
	LEADFAULT					✓	✓	
	CHECKELECTRODE					✓	✓	
NIBP	OVERP					✓	✓	
	OVERTIMECP					✓	✓	
	INFFAILURE					✓	✓	
	DEFFAILURE					✓	✓	
	MEASERROR					✓	✓	
	PULSETOOWEAK					✓	✓	
	CHECKSENSOR					✓	✓	
	AIRLEAK					✓	✓	
	EXCESSIVEMOTION					✓	✓	
	SYSTEMFAULT					✓	✓	
TEMP	TEMP-1-PROBEOFF					✓	✓	
	BM5Vet Elite, BM7Vet Elite Only	TEMP-2- PROBEOFF				✓	✓	
IBP	BM5Vet Elite, BM7Vet Elite Only	CABLEOFF				✓	✓	
		DISCONNECT				✓	✓	
		ZEROING				✓	✓	
		IMBALANCE				✓	✓	
ETCO2	MODULEOFF					✓	✓	

	CHECKADAPTER				✓	✓	
	CHECKLINE				✓	✓	
	CHECKLINEDISCONNECT				✓	✓	
	CO2INVALID				✓	✓	
	OVERRANGE				✓	✓	
	ZEROING				✓	✓	
	ZEROREQUIRED				✓	✓	
	SYSTEMFAULT				✓	✓	
	SENSORWARMUP				✓	✓	
	TEMPUNSTABLE				✓	✓	
SYSTEM	LOWBATTERY				✓	✓	

Abbreviations and Symbols

Abbreviations and symbols are alphabetized by reference, which can be read while reading the manual or using the equipment.

Abbreviations

A

A	amps
AC	alternating current
ADT	adult
ARRYTHM	arrhythmia
ASYS	asystole
Auto, AUTO	automatic
AUX	Auxiliary
aVF	left foot augmented lead
aVL	left arm augmented lead
aVR	right arm augmented lead

B

BPM	beats per minute
-----	------------------

C

C	Celsius
CAL	calibration
cm, CM	centimeter

D

D	diastolic
DC	direct current
DEFIB, Defib	defibrillator
DIA	diastolic

E

ECG	electrocardiograph
EMC	electromagnetic compatibility
EMI	electromagnetic interference
ESU	electrosurgical cautery unit

F

F Fahrenheit

G

g gram

H

HR heart rate, hour

Hz hertz

I

ICU intensive care unit

Inc incorporated

K

Kg, KG kilogram

KPa kilopascal

L

L liter, left

LA left arm, left atrial

LBS pounds

LCD liquid crystal display

LED light emitting diode

LL left leg

M

M mean, minute

m meter

MIN, minminute

MM, mm millimeters

MM/S millimeters per second

MMHG, mmHg millimeters of mercury

mV millivolt

N

NIBP non-invasive blood pressure

NEO, Neo neonatal

O

OR operating room

P

PED pediatric

PVC premature ventricular complex

Q

QRS interval of ventricular depolarization

R

RA right arm, right atrial

RESP respiration

RL right leg

RR respiration rate

S

S systolic

sec second

SpO₂ arterial oxygen saturation from pulse oximetry

SYNC, Sync synchronization

SYS systolic

T

Temp, TEMP temperature

U**V**

V precordial lead

V volt

V-Fib, VFIB ventricular fibrillation

VTAC ventricular tachycardia

W

X

X multiplier when used with a number (2X)

Y**Z****Symbols**

&	and
°	degree(s)
>	greater than
<	less than
-	minus
#	number
%	percent
±	plus or minus

Product Warranty

Product Name	Veterinary Multiparameter Monitor
Model Name	BM3Vet Elite / BM5Vet Elite / BM7Vet Elite
Product Permit No.	
Date of Issuing Product Permit	
Lot Number	
Warranty Period	One year from the date of purchase
Date of Purchase	Day Month Year
Customer Information	Name of Hospital: Address: Name: Phone:
Name of Seller	
Name of Manufacturer	

- ※ Thank you for purchasing BM3Vet Elite / BM5Vet Elite / BM7Vet Elite.
- ※ This product is a medical device.
- ※ This product has passed thorough quality control and strict inspection.
- ※ Compensation criteria for repair, exchange, and refund of this product are in accordance with the Fair Trade Commission Notice "Consumer Damage Compensation Regulations."



Bionet Co., Ltd.

Model Name: BM3Vet Elite / BM5Vet Elite / BM7Vet Elite