

Oxy9Wave Vet

Operation Manual

Ver. 1.55
(2023.05.22)



bionet

REVISION HISTORY

Revision No.	Date	Contents	Page
1.00	2023.04.04	First Written	All
1.54	2022.09.30	Contact Number Change	47
1.55	2023.05.22	Logo change Add IC Notice Modify the phrase (Attach the sensor to the hand or foot of the patient -> Attach the sensor to the tip of the patient's tongue.)	All 26

Contents

1. SAFETY INFORMATION.....	6
1-1. CE Standard Information.....	8
1-2. Warning	10
1-3. Caution	10
1-4. Note.....	10
1-5. SAFETY INFORMATION, WARNINGS, CAUTIONS, AND NOTES.....	10
2. Product description	12
2-1. Introduction	13
2-2. Product Configuration	13
2-3. Product Specifications	14
2-4. GENERAL DESCRIPTION	15
2-5. PRINCIPLE OF OPERATION.....	15
2-6. SYSTEM DESCRIPTION.....	16
2-7. How to Use the Sensor and Precautions.....	18
3. SETUP	19
3-1. LIST OF COMPONENTS.....	20
3-2. CONNECTING Oxy9Wave Vet TO DC POWER	20
3-3. CONNECTING A SENSOR TO Oxy9Wave Vet.....	21
3-4. CONNECTING a Clamp	22

4. OPERATION	23
4-1. Introduction	24
4-2. Symbol and Icon Description	25
4-3. Basic operation	26
4-3-1. Introduction	26
4-3-2. Basic Setup.....	26
4-4. Details of USE.....	27
4-4-1. Turning On the Monitor	27
4-4-2. Sensor Attached	28
4-4-3. Button Description	29
4-4-4. How to use the monitor.....	30
4-4-5. MENU SETUP	31
▣ ANIMAL TYPE	33
▣ Alarm Setup	33
▣ General Setup.....	35
▣ Clock Setup	36
▣ ABOUT	38
5. Alarms/Messages	39
5-1. Introduction	40
5-2. Alarm.....	40
5-3. Alarm operation.....	41
5-4. System messages.....	41
6. Standard Power Supply Application	42
6-1. Power	43
6-2. Battery Power Supply Application.....	44
6-3. When to Replace the Battery	45
6-4. How to Recycle the Battery.....	45

7. References and Others46

7-1. Cleaning and Maintenance.....47

7-2. Warranty Period47

**7.3 Federal Communication Commission Interference
Statement48**

7-4 IC Notice49

7-5. How to Contact Us.....50

● Due to continuing product innovation,
specifications in this manual are subject to change without notice.

1. SAFETY INFORMATION

1.1. CE Standard Information

1-2. Warning

1-3. Caution

1-4. Note

1-5. Safety Information, Warnings, Cautions, and Notes

1-1. CE Standard Information

▷ The following electromechanical safety standards have been met:

EN/IEC 60601-1 edition 3.0

Medical electrical equipment — Part 1: General requirements for basic safety and essential performance

EN/IEC 60601-1-2 edition 4.0

Medical electrical equipment

— Part 1-2: General requirements for basic safety and essential performance

— Collateral standard: Electromagnetic compatibility

— Requirements and tests

EN/IEC 62304 edition 1.0

Medical device software – Software life-cycle processes

EN/IEC 60601-1-6 edition 3.0

Medical electrical equipment - Part 1-6: General requirements for basic safety and essential performance - Collateral standard: Usability

EN/IEC 60601-1-8 edition 2.0

Medical electrical equipment - Part 1-8: General requirements for basic safety and essential performance - Collateral Standard: General requirements, tests and guidance for alarm systems in medical electrical equipment and medical electrical systems

ISO 80601-2-61:2011 edition 1.0

Medical electrical equipment -- Part 2-61: Particular requirements for basic safety and essential performance of pulse oximeter equipment

ISO 10993-10:2010

Biological evaluation of medical devices -- Part 10: Tests for irritation and skin sensitization

ISO 10993-5:2009

Biological evaluation of medical vices -- Part 5: Tests for in vitro cytotoxicity

EN ISO 14971:2012

Medical devices - Application of risk management to medical devices

EN 980:2008

Symbols for use in the labeling of medical devices

ISO 15223-1:2012

Medical devices -- Symbols to be used with medical device labels, labeling and information to be supplied -- Part 1: General requirements

MEDDEV 2.4/1 rev.9

Classification of medical devices (June 2010)

MEDDEV 2.7/1 rev.3

Clinical evaluation: Guide for manufacturers and notified bodies (December 2009)

MEDDEV 2.12/1 rev.8

Guidelines on a Medical Devices Vigilance System (January 2013)

EN ISO 13485 :2012

Medical devices — Quality management systems— Requirements for regulatory purposes
(ISO13485:2003)

EN/IEC 62366 edition 1.0

Medical devices-Application of usability engineering to medical devices

IEC 62471:2006

Photobiological safety of lamps and lamp systems.

IEC 60529:2001

Degrees of protection provided by enclosures (IPCode)

1-2. Warning



WARNING is provided when an action may cause a serious outcome (i.e., injury, serious adverse affect, death) to the patient or user. Refer to the text in the box.

WARNING : THIS IS A SAMPLE WARNING STATEMENT.

1-3. Caution

CAUTION is given when any special care is to be exercised by the patient or user to avoid injury to the patient, damage to this device, or damage to other property. Refer to the text in the box.

CAUTION : THIS IS A SAMPLE CAUTION STATEMENT.

1-4. Note

NOTE is provided when extra general information is applicable.

1-5. SAFETY INFORMATION, WARNINGS, CAUTIONS, AND NOTES

Oxy9Wave Vet is designed to minimize the possibility of hazards due to errors in the software program by following sound engineering design processes, Risk Analysis, and Software Validation.

WARNING : Check the items listed below before operating the equipment.

- Explosion hazard: Do not use the pulse Oximeter near flammable anesthetics or other flammable substance in combination with air, oxygen-enriched environments, or nitrous oxide.
- The Pulse Oximeter is NOT intended for use as apnea monitor.
- A Pulse Oximeter should be considered an early warning device. Given the trend toward patient hypoxemia, blood samples should be analyzed by laboratory instruments to understand the patient's condition completely
- The Pulse Oximeter is to be operated by qualified personnel only. This manual, the accessory directions for use, all precautionary information, and the specifications should be read before use.

- Electric shock hazard: Do not open the pulse oximeter cover except to replace the battery of the Handheld unit. Only a qualified operator may perform the maintenance procedures specifically described in this manual. Refer the servicing to Bionet for repair of this equipment.
- As with all medical equipment, carefully route the patient cabling to reduce the possibility of patient entanglement or strangulation.
- Do not place the pulse oximeter or accessories in a place that may cause it to fall on the patient. Do not lift pulse oximeter by the power cord or any other cable.
- Do not use the pulse oximeter or oximetry sensors during magnetic resonance imaging (MRI) scanning. Induced current could potentially cause burns. The pulse oximeter may affect the MRI image, and the MRI unit may affect the accuracy of the oximetry measurements.
- When using pulse oximetry during full body irradiation, keep the sensor out of the irradiation field. If the sensor is exposed the irradiation, the reading may be inaccurate or the unit may read zero for the duration of the active irradiation period.
- Do not place the pulse oximeter on electrical equipment, which may affect the pulse oximeter and prevent it from working properly.
- Do not expose the pulse oximeter to excessive moisture such as direct exposure to rain (excessive moisture can cause the pulse oximeter to perform inaccurately or fail).
- Do not place containers with liquids on or near the pulse oximeter (liquids spilled on the pulse oximeter may cause it to perform inaccurately or fail).
- Failure of Operation – If the pulse oximeter fails any part of the setup procedures or leak tests, discontinue the operation of the pulse oximeter until qualified service personnel have corrected the situation.
- Patient Safety – If a sensor is damaged in any way, discontinue use immediately.
- In case the equipment does not operate as usual, or It is damaged, do not use on the patient; contact the equipment supply division.

2. Product description

2-1. Introduction

2-2 Product Configuration

2-3. Product Specifications

2-4. GENERAL DESCRIPTION

2-5. PRINCIPLE OF OPERATION

2-6. SYSTEM DESCRIPTION

2-7. How to Use the Sensor and Precautions

2-1. Introduction

• Intended Use

Oxy9Wave Vet is a veterinary pulse oximetry that measures blood oxygen saturation from animals. This device is for use by trained veterinary personnel in veterinary centers. The device is restricted to be used on one patient at a time.

WARNING : Oxy9Wave Vet is intended only for adjunct use in patient assessment.
It must be used in conjunction with clinical signs and symptoms.

2-2. Product Configuration

- Major Components



2-3. Product Specifications

General Specification	
Dimension (H x W x D)	45 x 217 x 75 mm
Weight	Approx. 300g
Indicator	2 LED , 4 LED indicator
Power	AC 100-240V (50/60Hz) Adapter 5 V, 2.0 A
Power consumption	24VA (max)
Operating Mode	Continuous
Display	TFT-LCD
Resolution	320 X 480
Display size	3.5"
Displayed Data	SpO ₂ , BPM, SpO ₂ Limits, BPM Limits, Level Bar, Pulse rate Wave, Time and Date, Alarm Volume, Battery Status, and Brightness
LED Display	Sensor Separation, Alarm Silence, Charging Status, and Power Connection
Measurement Parameter	SpO ₂ , Pulse rate, PI (Perfusion Index)
Interface	DC input connector: 5V, 2.0A USB digital output for transferring data
Battery	Rechargeable Li-ion battery
Data Storage	SpO ₂ , BPM (30days at 10 second intervals)
Environments	
Temperature	Operating: +5 ~ +40 °C Storage: -20 ~ +70 °C
Humidity	Operating: 30% ~ 85%, Storage: 5% ~ 95%
Operating Attitude	Operating: 525 ~ 795 mmHg (70 ~ 106 kPa) Storage: 375 ~ 795 mmHg (50 ~ 106 kPa)
Bluetooth (Oxy9Wave Vet Plus only)	
Bluetooth version	Bluetooth 5
Frequency band	2.4 GHz
RF Output Power	Max +4 dBm (-20 ~ 4 dBm), Class 2
RF Receive Sensitivity	-96 dBm
Distance	100m in open space
SpO ₂ Performance	
Saturation range	40 to 100%

Oxy9Wave Vet Operation manual

Saturation accuracy	70 to 100% ± 2 digits 0 to 69% unspecified
Pulse rate range	18 to 450 bpm
Pulse rate accuracy	± 2 bpm or 2% of reading, whichever is greater.

2-4. GENERAL DESCRIPTION

Oxy9Wave Vet (Pulse oximetry) is a continuous, non-invasive method of measuring the level of arterial oxygen saturation in blood. The measurement is taken by placing a sensor on a patient – usually on the animal’s tongue. The sensor is connected to the pulse oximetry instrument with patient cable, collecting signal data from the patient and sending it to the instrument

The following figure shows the general monitoring setup:

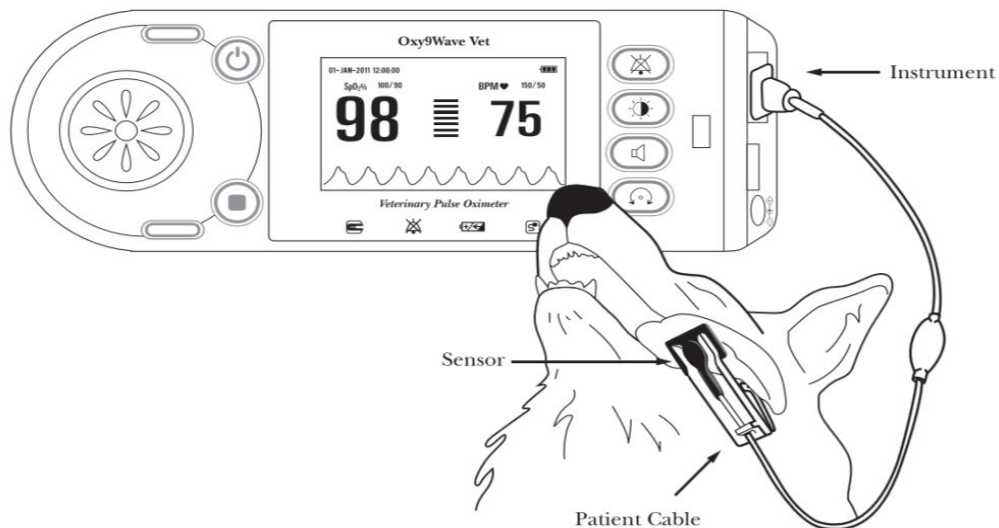

2-5. PRINCIPLE OF OPERATION

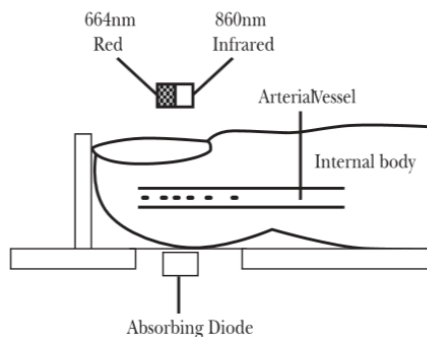

Oxy9Wave Vet uses the difference in absorbance that occurs when two lights with unique wavelength pass through a substance with different density. The principle of spectrum measurement is used. Specifically, it measures the ratio of absorbed red(664nm) and infrared

(860nm) light generated from these two light sources using the oxygen sensor after passing through an artery such as that in the fingers while the heart is beating. In other words, it uses the nature of absorbing more red light when passing through dark red blood which contains less oxygen and absorbing more infrared light when passing through scarlet blood which contains lots of oxygen.

2-6. SYSTEM DESCRIPTION

▣ Front View

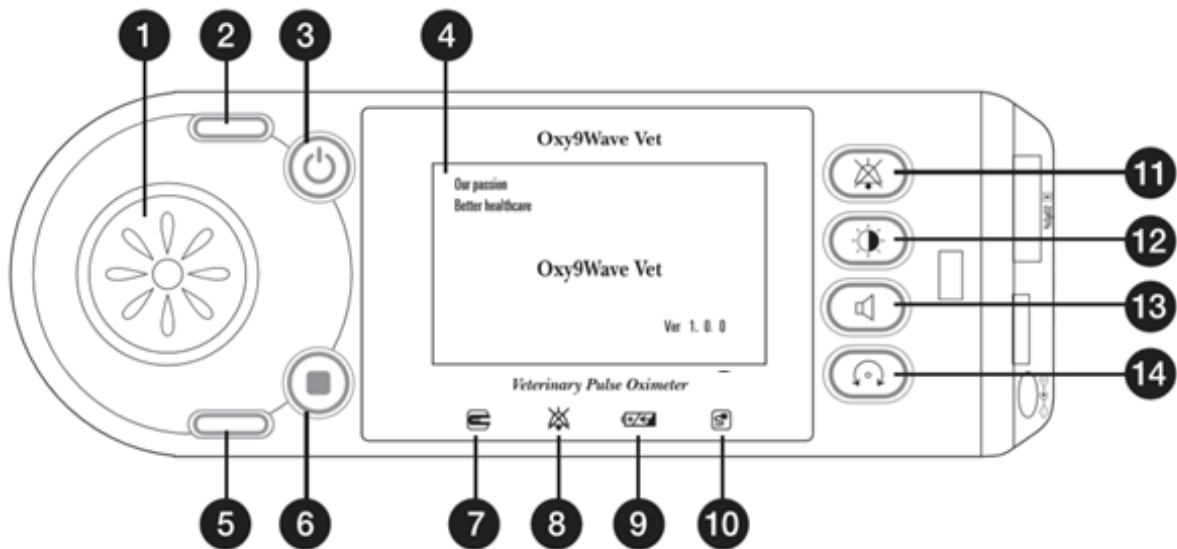

- | | |
|-------------------------|----------------------------------|
| 1. Speaker | 8. ALARM Silence Indicator |
| 2. ALARM LED | 9. BATTERY Charging Indicator |
| 3. POWER ON/OFF Button | 10. POWER Indicator |
| 4. DISPLAY Monitor | 11. Alarm Silence Setting Button |
| 5. PULSE RATE LED | 12. BACKLIGHT Setting Button |
| 6. MENU Button | 13. Pulse beep Setting Button |
| 7. SENSOR OFF Indicator | 14. Rotate Display Button |

▣ Slide View



▣ Back View

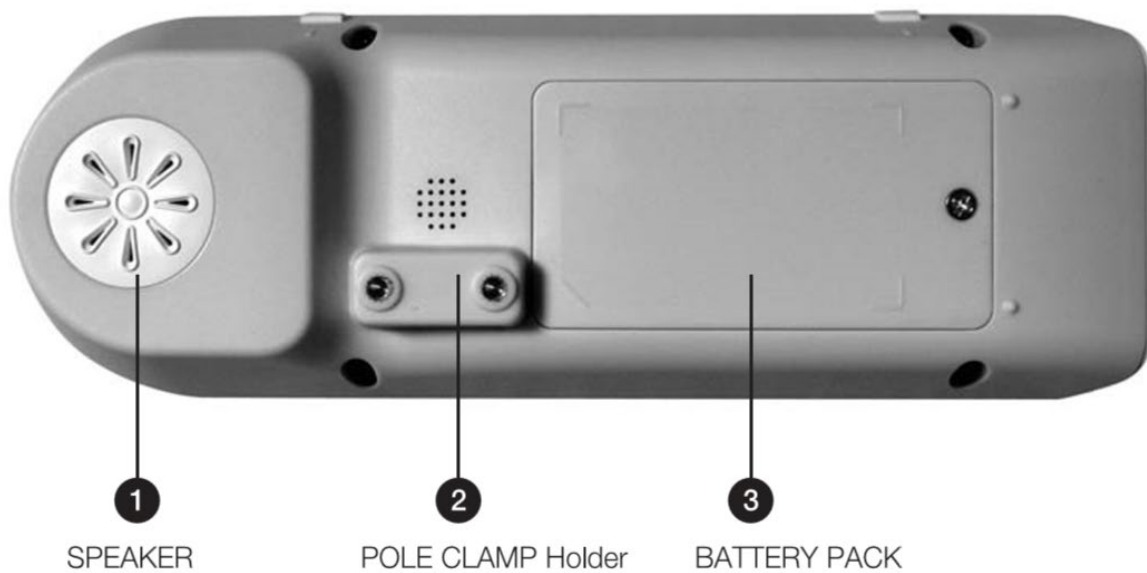

2-7. How to Use the Sensor and Precautions

WARNING : Our SPO₂ Sensor is a medical product and should be used accordingly. Improper use or use of other sensors may cause harm to the user.

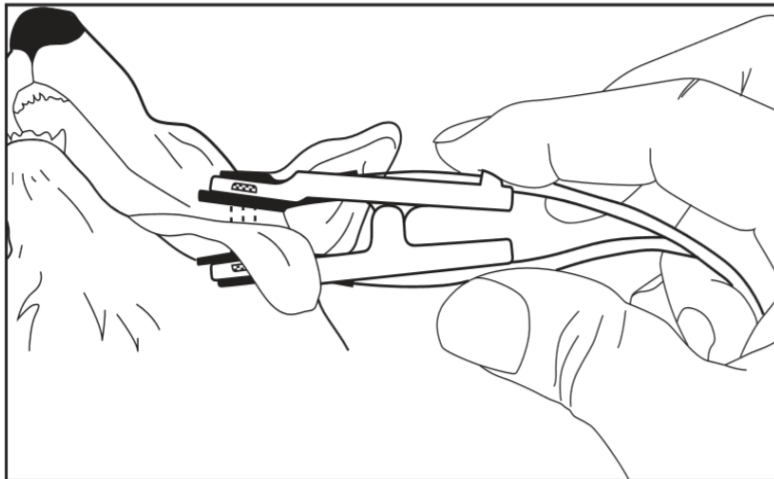
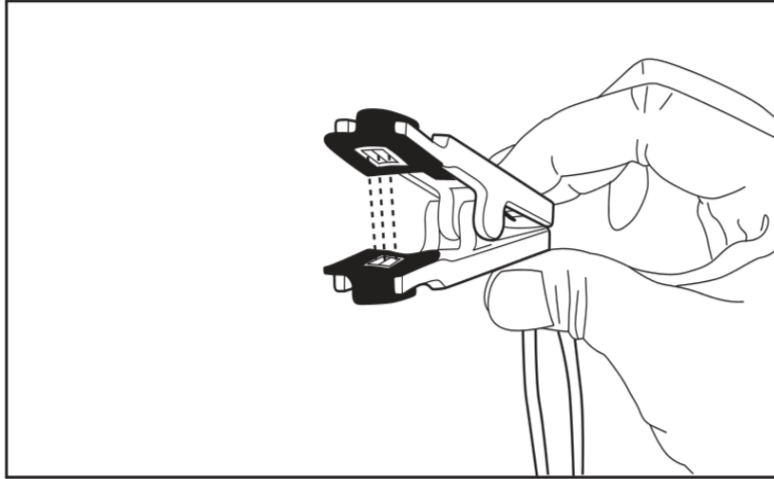

How to use

Place the probe on the animal's tongue as indicated in the illustration.

CAUTION :

- When used near EMI devices such as a microwave oven or high-frequency RF electronics, the readings may not be correct.
- When used continuously
Check the sensor every 8 hours and cycle power on the unit every 4 hours.
- When not in use, store the unit at -20 °C-+70°C

3. SETUP

3-1. LIST OF COMPONENTS

3-2. CONNECTING Oxy9Wave Vet TO DC POWER

3-3. CONNECTING A SENSOR TO Oxy9Wave Vet

3-4. CONNECTING a Clamp

3-1. LIST OF COMPONENTS

- Oxy9WaveVet Main Body 1ea
- Power Adaptor 1ea
- SpO₂ Sensor 1ea
- Lithium-ion Battery 1ea
- Pole Clamp 1ea
- Manual 1ea
- Power Cord 1ea
- USB Cable (Optional) 1ea
- Oxy9Wave Viewer Installation CD (Optional) 1ea

3-2. CONNECTING Oxy9Wave Vet TO DC POWER

WARNING :

The AC-DC adaptor (BPM010S05N07) supplied is to be used for medical purposes only.
Never use other DC adaptors with this product.

The DC power and battery power can be used simultaneously.

[DC Power]

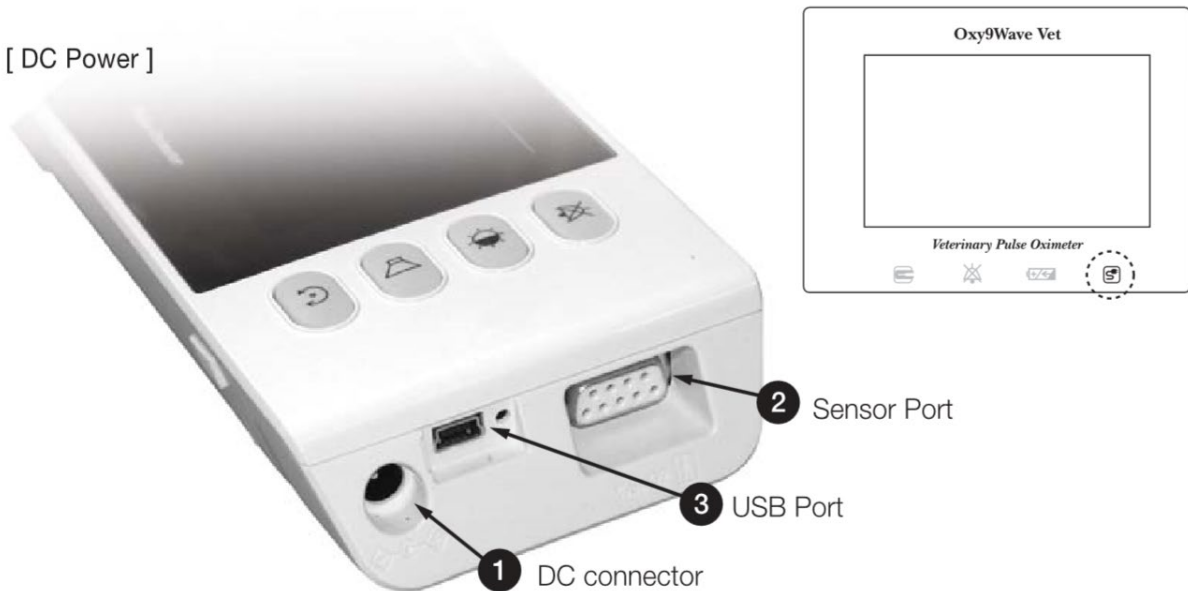

The DC Power LED lights up when DC Power is plugged into the inlet on the side of the product.
Pressing the power key makes the machine ready for use.

[Battery Power]

Connect the battery as shown below.

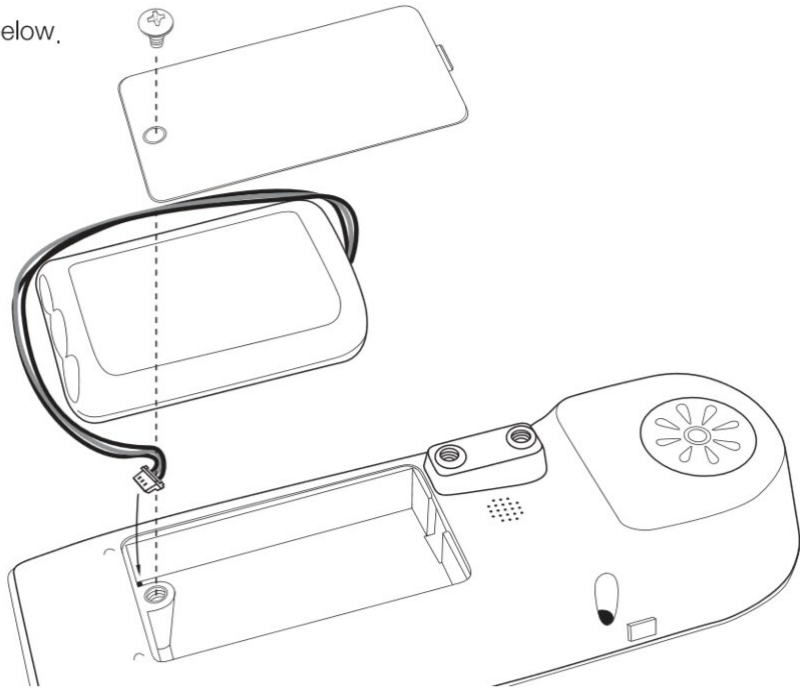

CAUTION : Check the electrodes of the batteries before charging them.
Connect the DC adaptor when changing the battery.

3-3. CONNECTING A SENSOR TO Oxy9Wave Vet

WARNING : Our SpO₂ Sensor is a medical product and should be used accordingly.
Improper use or use of other sensors may cause harm to the user.



Connect a SpO₂ sensor cable to the SpO₂ sensor port (2) of the side panel.

3-4. CONNECTING a Clamp

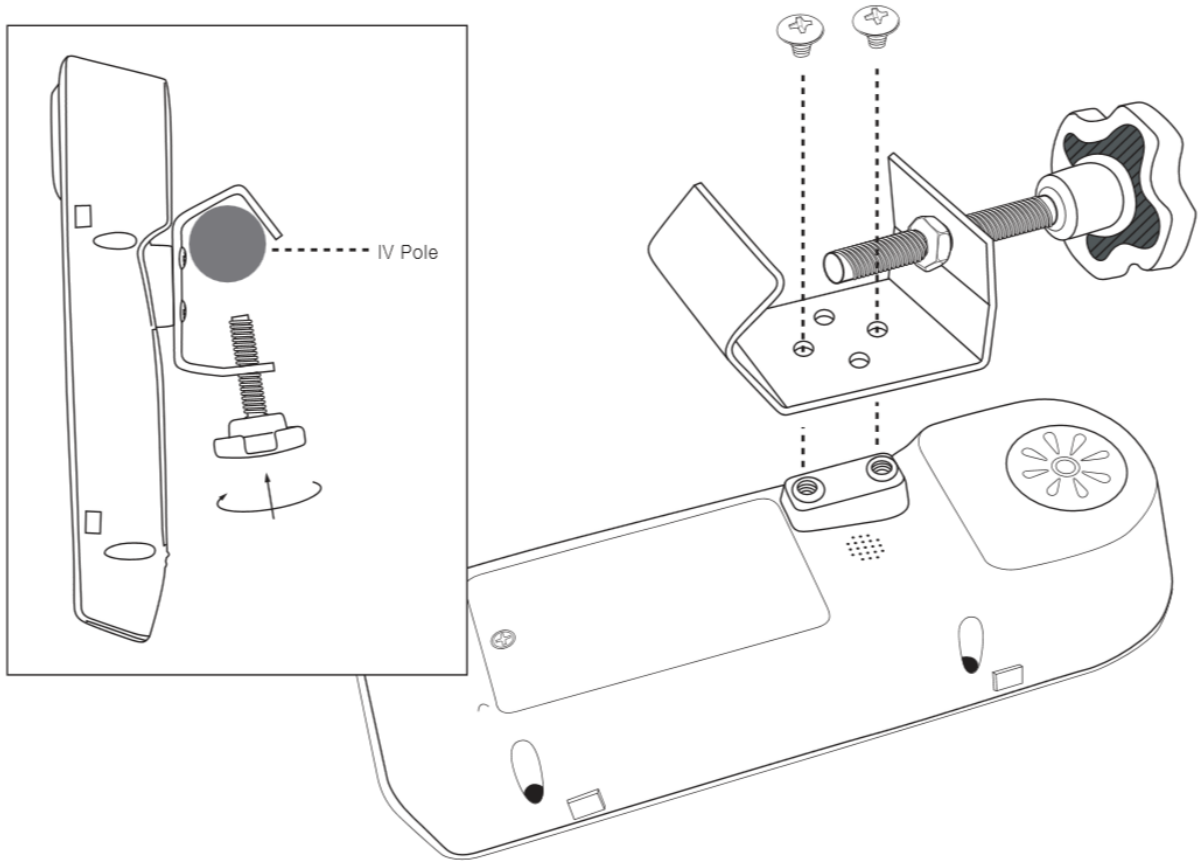

4. OPERATION

4-1. Introduction

4-2. Symbol and Icon Description

4-3. Basic operation

4-3-1. Introduction

4-3-2. Basic Setup

4-4. Details of USE

4-4-1. Turning On the Monitor

4-4-2. Sensor Attached

4-4-3. Button Description

4-4-4. How to use the monitor

4-4-5. MENU SETUP

MENU TREE

Alarm Setup

General Setup

Clock Setup

ABOUT

4-1. Introduction

The parameters of the Oxy9Wave Vet monitor are preset to factory default.



















The factory/default setting for the parameters may be changed to institutional default setting by following the procedures in the Oxy9Wave Vet service manual.

The table below lists the parameters, ranges available, and factory default.

The parameters may be set on an individual basis by the clinician; these settings will remain in effect until Oxy9Wave Vet is turned off.

Parameter	Range	Factory Default
ANIMAL TYPE	CAT / DOG	CAT
%SpO ₂ Upper Alarm Limit	41 ~ 100%	100%
%SpO ₂ Lower Alarm Limit	40 ~ 99%	90%
BPM Upper Alarm Limit	19 ~ 450 bpm	200 bpm
BPM Lower Alarm Limit	18 ~ 449 bpm	70 bpm
%SpO ₂ LEVEL	H / M / L	H
BPM LEVEL	H / M / L	H
Alarm Volume	1~5	4
Alarm	ON / OFF	ON
Alarm Silence Duration	90, 120, OFF	OFF
Brightness	1~5	4
Pulse beep	1~4 OFF	3
Display View	GRAPHICS / NUMBERS	GRAPHICS
SAVE	AUTO / EVENT / OFF	OFF
INTERVAL	10 / 30 / 60 SEC	10 SEC
DELETE	NO / YES	NO
KEY SOUND	ON / OFF	ON
PULSE LED	ON / OFF	ON
DEFAULT	NO / YES	NO

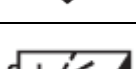
4-2. Symbol and Icon Description

	Warning
	Type BF
	Connect DC power
	Class II equipment
	Power button on/off
	Menu button
	Alarm silence
	Alarm OFF
	Screen brightness Adjusted as one of 5 levels based on the brightness
	Pulse beep Volume Adjusted as one of 5 levels based on the volume
	Screen rotation
	Data Save
	Back to the previous mode icon
	Enter/Go to
	Up/Change setting
	Down/Change setting
	Battery charging
	Bluetooth wireless communication is on.

4-3. Basic operation

4-3-1. Introduction

To operate the Oxy9Wave Vet Pulse Oximeter effectively, the device must be set up properly, and the operator must:

- Know how the pulse oximeter derives its readings.
- Be familiar with its controls, components, and operation.
- Understand its status and the alarm messages.

4-3-2. Basic Setup

[GENERAL SETUP AND USE]

1. Check whether the case is damaged.
2. Connect the cable and connector and check whether the lines are twisted or a corner is worn out.
3. Connect the power cord and turn on the power.
4. Check whether the SpO₂ sensor is the one we approved and provided and remove objects that can interfere with the transmission of light between the light source and the photo detector.
5. Press the power button.
6. Attach the sensor to the tip of the patient's tongue.
7. Check the following on the screen :
 - %SpO₂, max/min alarm value of BPM
 - %SpO₂, and value of BPM

NOTE : If it is displayed as a bar rather than as a value, please wait about 10 seconds.
8. You can set the volume of Pulse beep and alarm.
 - When the value exceeds the designated range, the alarm rings, and the color is changed.
9. Check the status of the sensor (message).
 - "Check Probe"(not connected to patient) is displayed in the message zone.
 - "Lead Fault"(sensor is not connected) is displayed in the message zone.
 - "Artifact signal"(sensor is moving too fast) is displayed in the message zone.
10. Alarm Silence
 - Button to stop the alarm that sounds when the designated range is exceeded.
 - Press the Alarm Silence button.
 - The alarm will stop during the designated period.
11. Monitor the patient.

4-4. Details of USE

4-4-1. Turning On the Monitor

Before using Oxy9Wave Vet on the patient, the proper working condition of the device must be verified each time Oxy9Wave Vet is turned on as described in the following procedure:

CAUTION : If any indicator or display element does not light up when the pulse oximeter is turned on, do not use the pulse oximeter. Instead, contact any qualified service personnel, your local Bionet representative, or the Bionet Technical Services Department.

1. Turn on Oxy9Wave Vet by pressing the POWER ON/OFF button for 1-2 seconds.
2. The Oxy9Wave Vet software version is displayed for approximately 2 seconds.

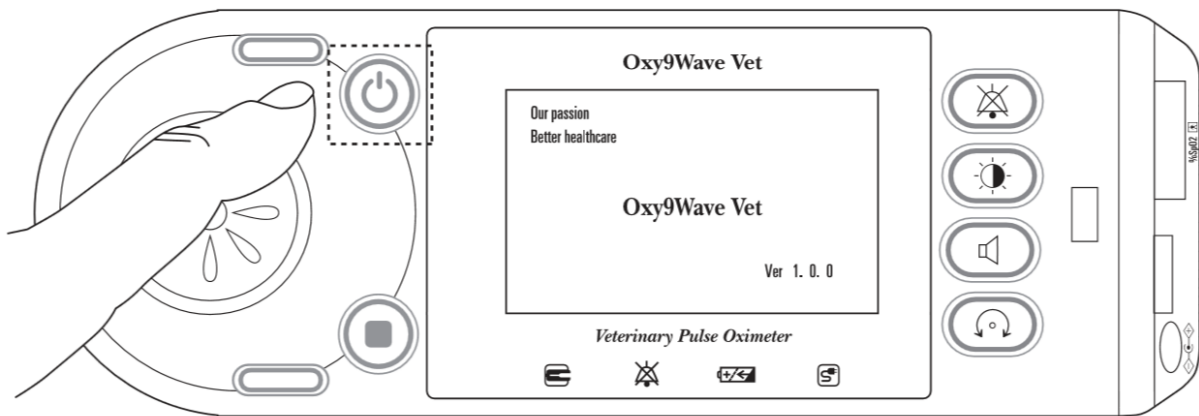

3. The Oxy9Wave Vet Monitoring Mode is displayed.

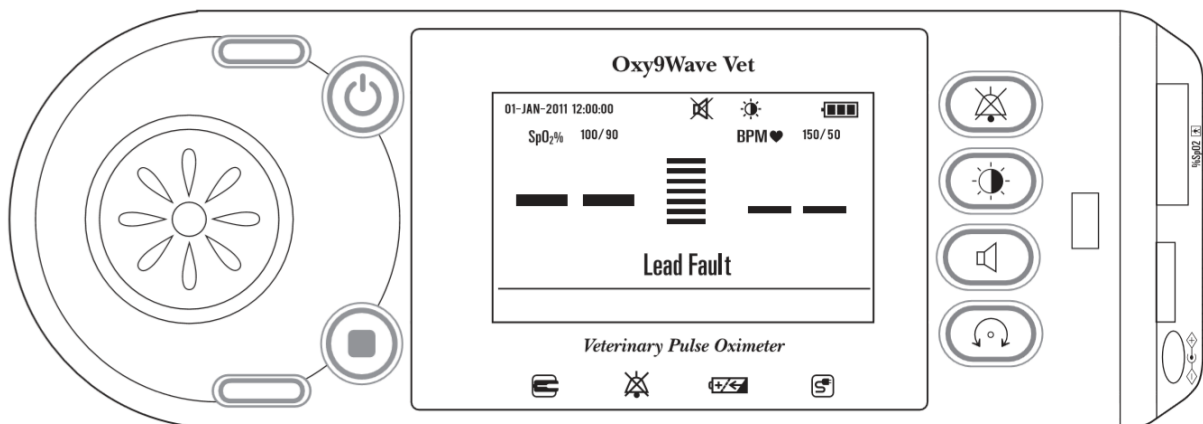

4-4-2. Sensor Attached

[No Sensor Attached]

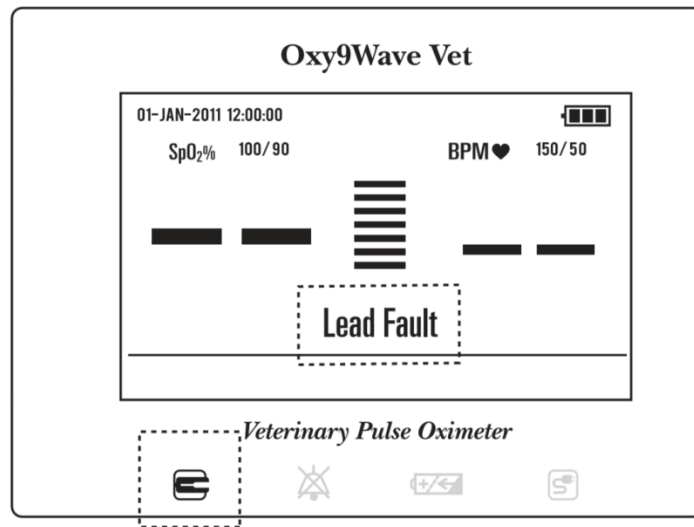

The monitor displays dashed (---), indicating the "Lead Fault" message.

[When the Sensor is Attached]

When a sensor is attached to the monitor, the sensor status is displayed on the monitor.

The monitor displays a bar in the %SpO₂ and the Pulse Rate while Oxy9Wave Vet is searching for a valid pulse. Once a valid pulse is detected, the monitor shifts to Monitoring Mode and displays the patient parameters. Check for the movement of the level bar or waveform, which indicates that the monitor is displaying real-time data.

< Sensor Message >

1. Sensor is not connected to a patient : Check Probe
2. Sensor is connected to a patient (searching a pulse) : Pulse Search
3. During normal measurement after the sensor is connected : Message is not displayed.
4. Sensor is moving too fast during measurement : Artifact signal

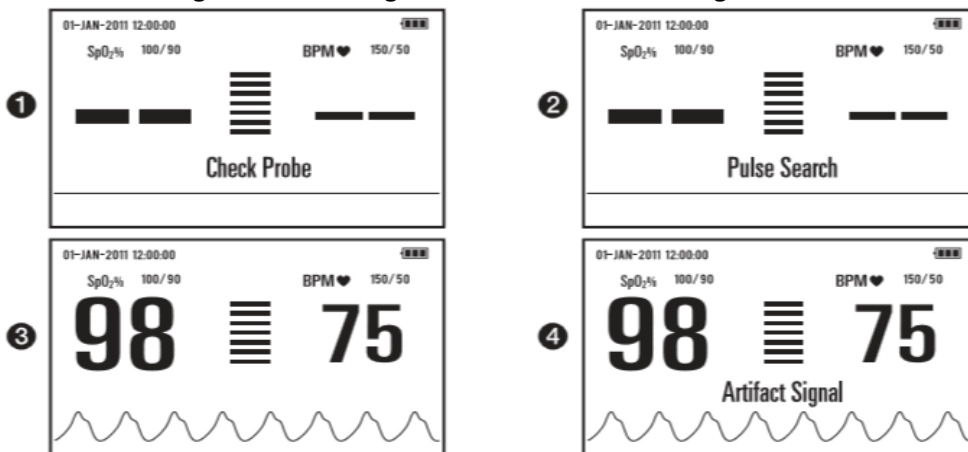

4-4-3. Button Description

(Alarm Silence, Brightness Adjustment, Pulse beep Volume Adjustment, Screen Rotation)

Description of 4 buttons on the right in the patient monitoring mode

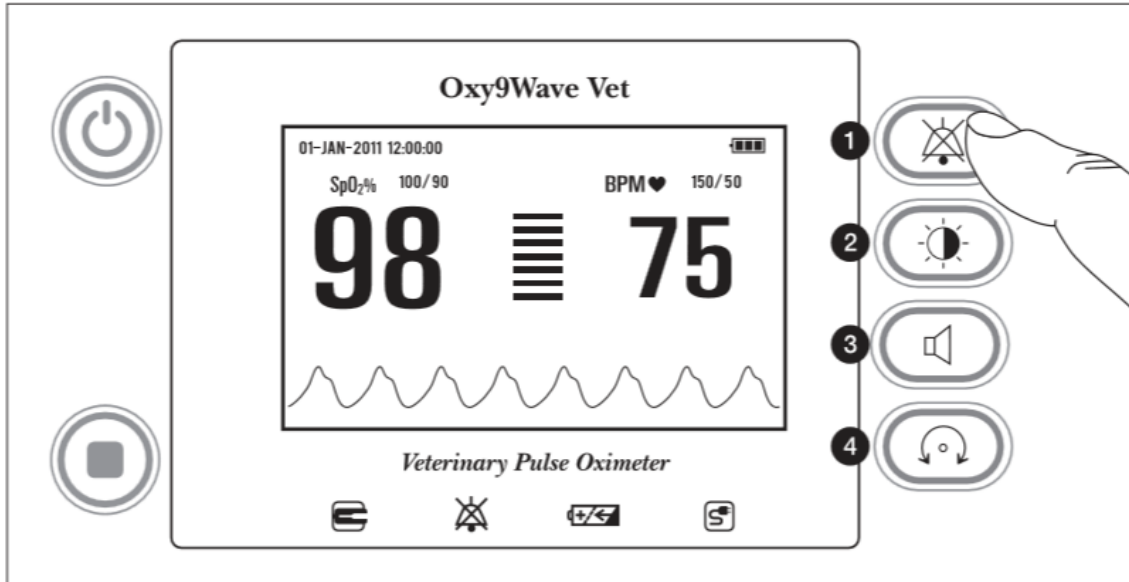

[Alarm Silence]

The user can adjust the period of alarm silence duration.

Pressing this button stops the alarm temporarily for the designated period when the alarm sounds.

- ①
-  1. Press the Alarm Silence button when the alarm sounds in the patient monitoring mode.

NOTE : The alarm silence can be set for these duration (90, 120, OFF) A timer is shown next to the bell indicating the remaining alarm silence duration.

[Brightness Adjustment]

NOTE : To adjust the backlight when it is dark, follow the procedures below.

- ②
-  1. Press the Brightness Adjustment button.
2. You can change the level of backlight to any of the 5 levels by pressing the button. Each level is displayed on the upper right side.

NOTE : To use the battery efficiently, select the lowest brightness.

[Setting the Pulse Beep Volume]

③



1. Press the Pulse Beep setting button.
2. Each step is displayed on the upper part of the screen.

The Button is used to change the sound level, Five levels of volume are available.

NOTE : During measurement, the pulse beep sound (tone) is changed automatically according to the value of SpO₂.

[Rotate Display]

④



1. Press the Rotate Display Button.

NOTE : The display rotates 90 degrees.

4-4-4. How to use the monitor

[Setting the Patient Monitoring Mode for Oxy9Wave Vet]

The user can configure the display settings.

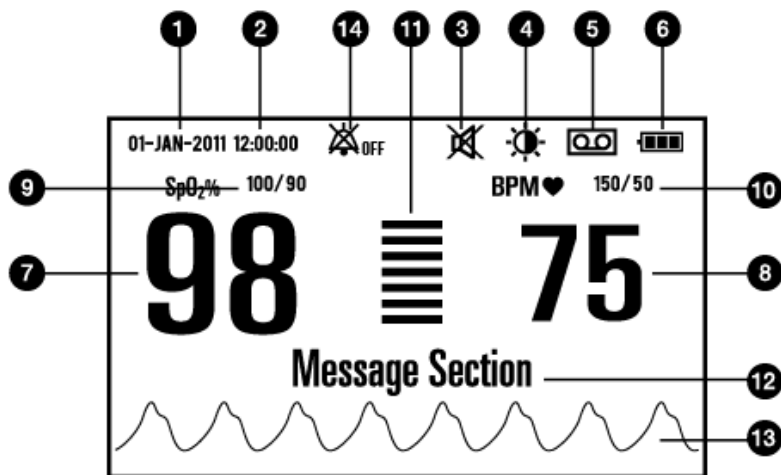

- | | |
|----------------------|---|
| 1. Calendar | 8. Pulse rate |
| 2. Clock | 9. SpO ₂ Max/Min alarm limit |
| 3. Sound volume icon | 10. BPM Max/Min alarm limit |
| 4. Brightness icon | 11. Level bar |
| 5. Save data icon | 12. System message |
| 6. Battery icon | 13. Waveform graph |
| 7. %SpO ₂ | 14. Alarm sound off icon |

[Setting the Patient Monitoring Mode for Oxy9Wave Vet Plus]

The user can configure the display settings.

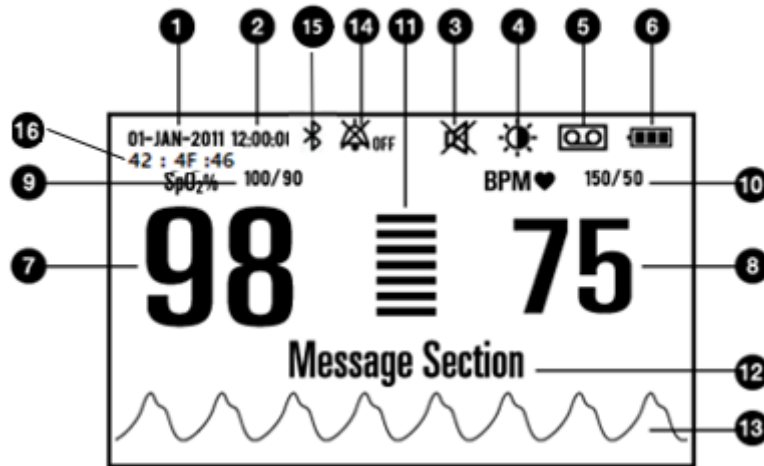

- | | |
|----------------------|---|
| 1. Calendar | 9. SpO ₂ Max/Min alarm limit |
| 2. Clock | 10. BPM Max/Min alarm limit |
| 3. Sound volume icon | 11. Level bar |
| 4. Brightness icon | 12. System message |
| 5. Save data icon | 13. Waveform graph |
| 6. Battery icon | 14. Alarm sound off icon |
| 7. %SpO ₂ | 15. Bluetooth on icon |
| 8. Pulse rate | 16. Bluetooth MAC address |

4-4-5. MENU SETUP

In menu setup, you can adjust the alarm setting, screen composition, data save, time and date display, etc.



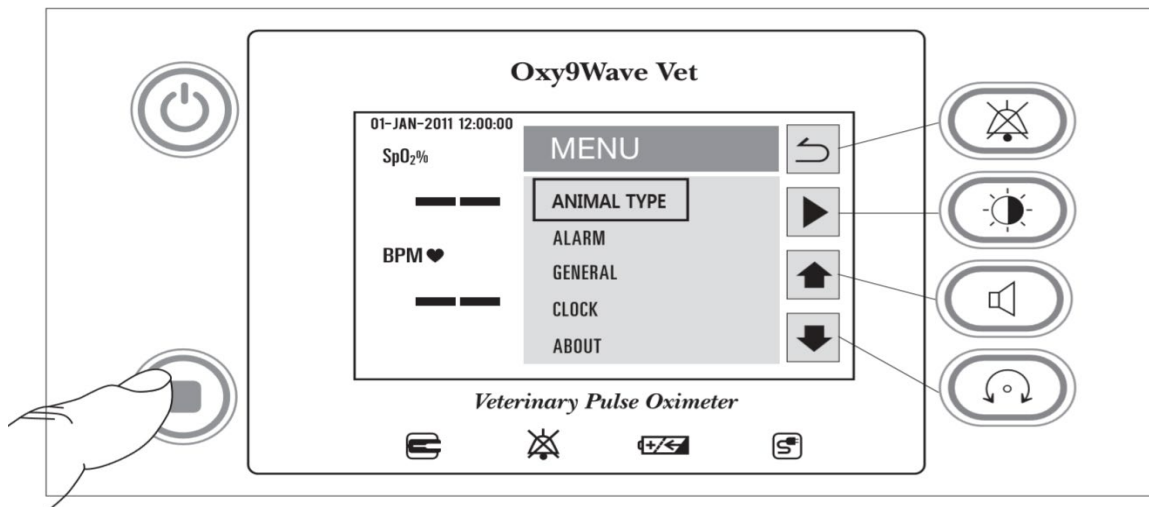

The menu screen consists of ANIMAL TYPE, ALARM, GENERAL, CLOCK, and ABOUT



1. Press the menu button to go to the corresponding menu setup screen.
2. The icons on the right side show the functions of the 4 buttons.

NOTE : The menu setup screen and monitoring and measurement screen are shown alternately when you press the menu button.

[Select Menu]

1.  Press the menu button.
2. Press the   button to go to menu you want to change.
3. Press the  button to go to the desired menu.

▣ MENU TREE

This section gives an overview of the menu selections that are available. To navigate through the menus, press the menu button on the right side using the touch keys. The icons of the menu items that can be set appear on the screen. The following sub-sections describe each menu item in more detail :

ANIMAL TYPE	CAT/DOG
-------------	---------

ALARM	% SpO ₂ high/low limit
	BPM high/low limit
	LEVEL(% SpO ₂ , BPM)
	VOLUME
	ALARM

GENERAL	VIEW
	SAVE
	INTERVAL
	DELETE

CLOCK	TIME(hour/minute/second)
	DAY
	MONTH
	YEAR
	FORMAT



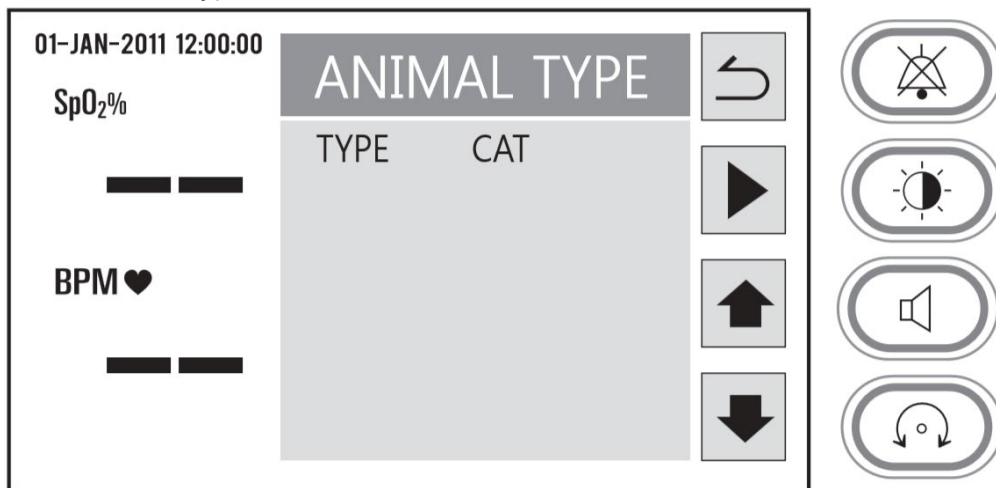

ABOUT	VERSION
	KEY SOUND
	PULSE LED

▣ ANIMAL TYPE

Set the Animal type.



[How to set the Type]

1. Press the  button to go to the desired value.
2. Press   to set the value.
3. Press the  button to return to the Menu.

▣ Alarm Setup

Set the proper alarm when monitoring each patient.



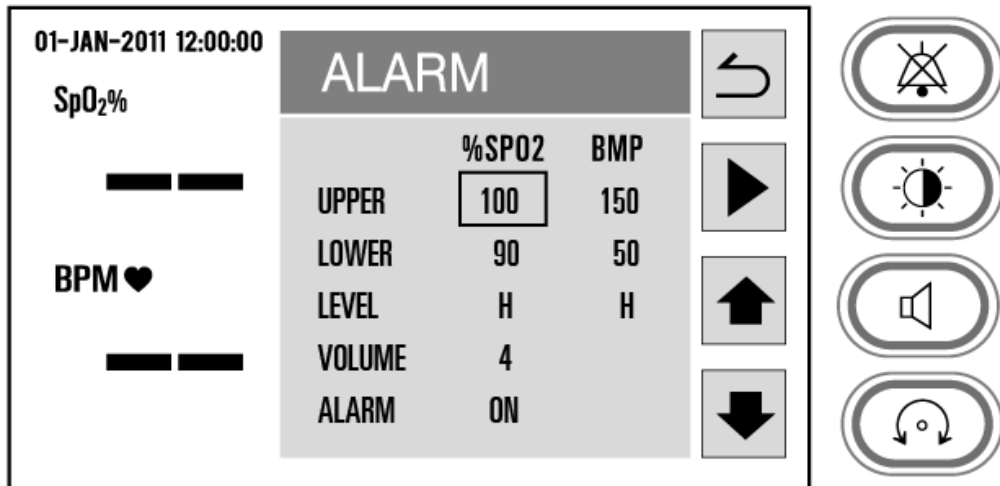

Alarm setup is used to indicate that the designated range is exceeded during measurement.

You can set the Max/Min Value, volume, and silence period of alarm.









The user can adjust the period of alarm silence duration.

[How to set the alarm]

1. Press the  button to go to the desired value.
2. Press   to set the value.
3. Press the  button to return to the Menu.

[Description]

Setup Menu	Description
Max SpO ₂ (UPPER)	Max SpO ₂ for alarm can be 41-100%. It can be adjusted by 1% <div style="display: flex; justify-content: space-around; align-items: center;"> <div style="text-align: center;"> (Menu)</div> <div style="text-align: center;"> (Alarm setup Screen)</div> <div style="text-align: center;"> (Adjust Max Limit)</div> </div>
Min SpO ₂ (LOWER)	Min SpO ₂ for alarm can be 40~99%. It can be adjusted by 1% <div style="display: flex; justify-content: space-around; align-items: center;"> <div style="text-align: center;"> (Menu)</div> <div style="text-align: center;"> (Alarm Setup)</div> <div style="text-align: center;"> (Move to Min Limit)</div> <div style="text-align: center;"> (Adjust Min Limit)</div> </div> <p>NOTE : limit must be smaller than Max limit.</p>
Max PULSE RATE (UPPER)	The max BPM for alarm can be 19bpm~450bpm, and it can be adjusted by 1bpm.
Min PULSE RATE (LOWER)	The min BPM for alarm can be 18bpm~449bpm, and it can be adjusted by 1bpm NOTE : The Min limit must be smaller than the Max limit.
LEVEL (% SpO ₂ , BPM)	This menu allows the user to set the alarm level. (HIGH, MEDIUM, LOW)

VOLUME	This menu allows the user to set the alarm volume (5step.)
--------	--

WARNING : Any alarm levels can be turned off, including lethal alarms.
 Parameters configured to use All Off do not have any visual or audio alarm indicators

■ General Setup

Menu for setting the screen display and saving and deleting data

[General Setup Screen]

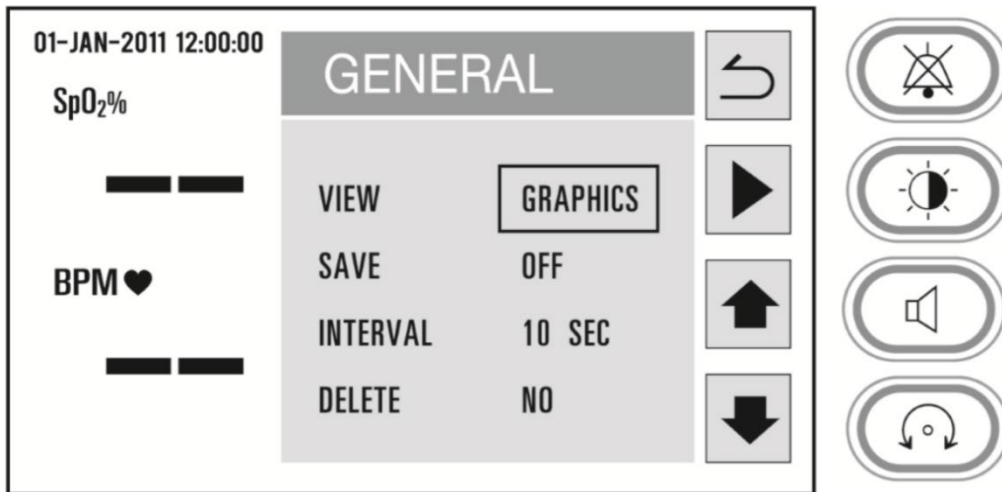

[Procedure for General Setup]

1. Press the button to go to the desired value.
2. Press to set the value.
3. Press the button to return to the Menu.

Setup Menu	Description
VIEW	Menu for the screen settings GRAPHICS %SpO ₂ and Pulse rate are displayed as a figure; the LEVEL bar of the middle signal is displayed. In addition, the Pulse rate wave is displayed at the bottom of the screen. NUMBERS %SpO ₂ and Pulse rate are displayed as a figure; the LEVEL bar of the middle signal is displayed
SAVE	AUTO : Data is saved automatically.

	EVENT: Data is saved after in the Event happen. NOTE : The saving icon is displayed when saving data.
INTERVAL	Set interval of saving among 10/30/60
DELETE	YES/NO : Delete saved data.



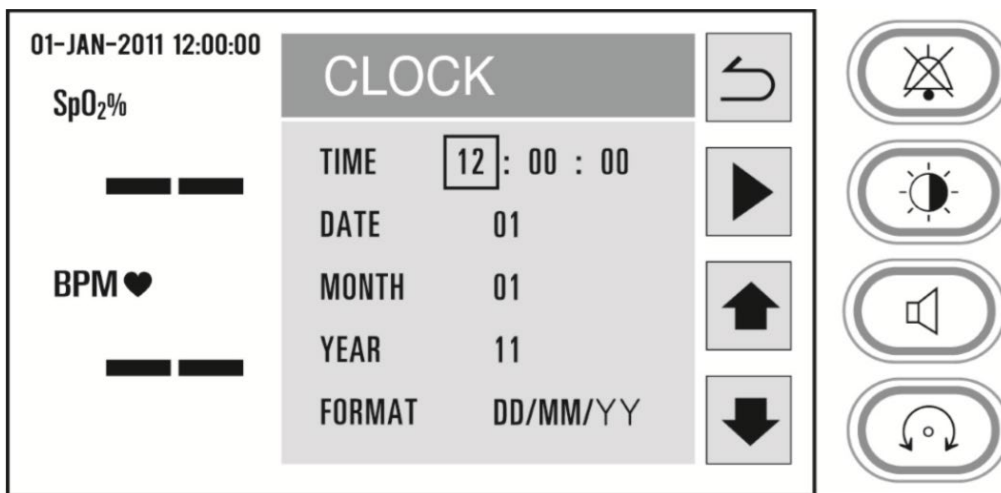

■ Clock Setup

Set the current time and date.

[Clock Setup Screen]



[Procedure for Clock Setup]

1. Press the  button to go to the desired value.
2. Press   to set the value.
3. Press the  button to return to the Menu.

Setup Menu	Description
TIME	Adjust the hour, minute, and second Time is displayed based on 24-hour notation.
DATE/ MONTH/ YEAR	Adjust the date.
FORMAT	DD/MM/YY, MM/DD/YY , YY/MM/DD It is the form of the clock displayed on the screen. The default setting is DD/MM/YY.



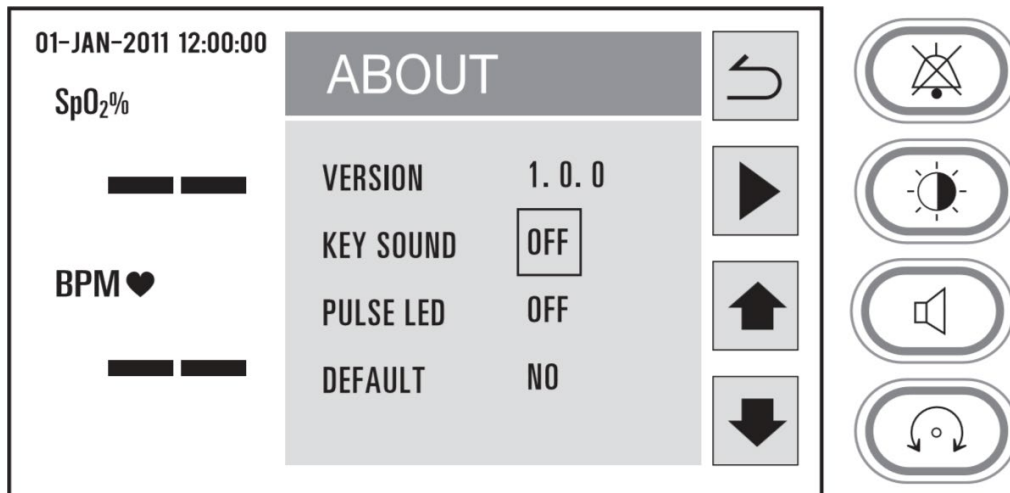

▣ ABOUT

Menu for checking the version and resetting the system and other settings.

[ABOUT Screen]



[Procedure for About Setup]

1. Press the  button to go to the desired value.
2. Press   to set the value.
3. Press the  button to return to the Menu.

Setup Menu	Description
KEY SOUND	- ON : Turn on the KEY tone. - OFF : Turn off the KEY tone.
PULSE LED	- ON/OFF - OFF : Turn off the Pulse Rate LED indicator.
DEFAULT	- YES/NO Factory Default is used to reset the system. If you select YES, the product will return to the initial status.

WARNING : If the product is reset, all saved data will be lost, Therefore, take the necessary caution.

5. Alarms/Messages

5-1. Introduction

5-2. Alarm

5-3. Alarm operation

5-4. System messages

5-1. Introduction

The following section outlines the system alarms and messages displayed on the LCD screen : Familiarize yourself thoroughly with this information before operating the pulse oximeter

5-2. Alarm

Oxy9Wave Vet visually and audibly indicates the alarm conditions detected by the system. In particular, the integrated loud speaker indicates the alarm conditions audibly. The LCD screen and the LED lights indicate the visual alarms. Audible alarms may be silenced without affecting the operation of visual alarms.

The following table outlines the alarm priority specifications:

ALARM	DESCRIPTION
HIGH PRIORITY	- Audible and visual alarms for low saturation (%SpO ₂ range:40~100%) And pulse rate (pulse rate range : 18~450 bpm).
MEDIUM PRIORITY	- Audible and visual alarms for low saturation (%SpO ₂ range:40~100%) And pulse rate (pulse rate range : 18~450 bpm). - Low battery
LOW PRIORITY	- Audible and visual alarms for low saturation (%SpO ₂ range:40~100%) And pulse rate (pulse rate range : 18~450 bpm). - Patient is not connected to the SpO ₂ Sensor. - Main body and SpO ₂ Sensor are not connected properly.

A visual alarm will be displayed in a different color and rate defined in the table below depending on its priority.

Alarm Level	LED Color	LED Flashing Duty Cycle
High Level	Red	2 flickers per 1 second
Medium Level	Yellow	1 flicker per 2 seconds
Low Level	Blue	keep ON state

Audible alarm settings are defined by Bionet. Audible alarm priority is defined by the alarm interval and beep rate as shown in the table below.

Alarm Level	Audible Alarm Interval	Beep Rate	Sound Pressure level
High Level	Continuous	5 beeps	66.4 dB ~ 75.8 dB
Medium Level	Every 10 sec	3 beeps	62.0 dB ~ 75.8 dB
Low Level	Every 15 sec	1 beeps	58.2 dB ~ 74.6 dB

5-3. Alarm operation

Alarm is a function that allows the user to listen the alarms when they exceed the limits of the oxygen saturation and the limits of the max/min values of the heart rate.

If the alarm limit exceeds the set limit, the ALARM LED flickers instantly and the measured data displays on the screen visually with the alarm sound. If an alarm is paused by Alarm Silences button, the ALARM LED flickers on the front visually without any sound.

5-4. System messages

The chart below alphabetically lists all system messages displayed on the LCD screen (the cause of the message and action(s) to be taken are also shown)

The operator should thoroughly familiarize himself/herself with this information before using the oximeter for patient monitoring.

ARTIFACT -

The SPO₂ signal is the patient's motion artifact and noise.

Check Probe -

SPO₂ data continues to be displayed, but the quality of the signal is questionable.

Check the patient and the probe.

Lead Fault –

If the multisite probe is detached from the patient, check the SpO₂ sensor.

If the SpO₂ sensor is not connected and the power of the device is turned on, the message alarm is activated. If the SpO₂ sensor is not connected from the device after connecting it to the device, a low alarm is activated.

Poor Signal –

The SPO₂ signal is too low. No SPO₂ data is displayed. This can be due to low patient pulse, patient motion, or some other interference. Check the patient and the probe.

Pulse Search –

Detection by the monitor of a repeatable pulse has ceased. Check the patient and the probe site.

NOTE : No SPO₂ data is displayed. One of the following conditions is indicated:

- Defective or damaged probe
- Defective or damaged cable
- Probe is detached from the patient.
- Detection of repeatable pulse has ceased.
- Check the probe and cable: reposition or replace as needed.

NOTE : When 'Artifact Signal' is displayed, measured values are displayed in gray.

- These indicate the most recently measured value among those measured under normal conditions

6. Standard Power Supply Application

6-1. Power

6-2. Battery Power Supply Application

6-3. When to Replace the Battery

6-4. How to Recycle the Battery

6-1. Power

①

②

The Power LED lights up when Power is plugged into the inlet at the back of the product. Pressing the power key makes the machine ready for use.

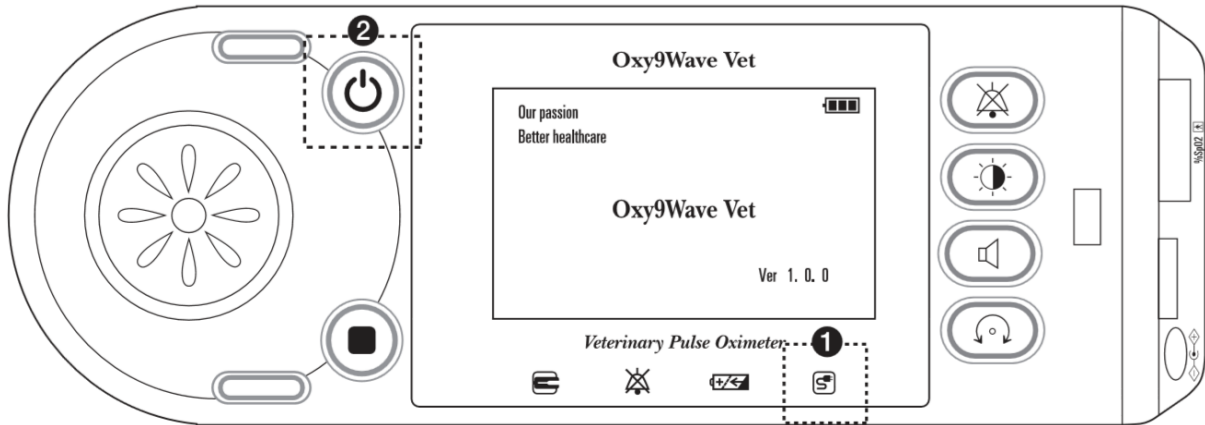

CAUTION :

- This Product is intended for indoor use only.
- Not water-resistant
- This product should be protected from excessive force or shock.
- Do not pull the output plug excessively.
- No user-serviceable part inside
- Use only the rated input and output range indicated at the bottom of the equipment.

WARNING : The AC-DC adaptor (BPM010S05N07) supplied is to be used for medical Purpose only.
Never use other DC adaptors with this product.

If you use the adaptor of other companies, the Power LED will flicker, and the battery will not charge. Take the necessary caution.

6-2. Battery Power Supply Application

WARNING : Dispose of battery in accordance with local requirements and regulations.

Battery power can be supplied to enable portable use or for use in case of DC power failure.

< Operation >

1. The Battery Power LED lights up when the machine is in use.
2. Battery power lasts for 20 hours.
3. The battery is automatically charged when the machine is connected to DC Power Supply. The Battery LED lights up after blinking.
4. The charging status of the batteries is displayed as 3 boxes, each indicating a different charging level.



< Battery type >

The lithium-ion battery is a rechargeable battery containing lithium-ion cells. Each battery contains an integrated electronic fuel gauge, a safety protection circuit, and a temperature sensor.

5. When the remaining battery power is only 10%, power is automatically cut off after 5 minutes. The machine will no longer operate when the battery icon flashes. Charge the batteries with the power adaptor provided by BIONET

WARNING : Check the electrodes of the batteries before charging them.
Likewise, connect the DC adaptor when charging the battery.

6. Battery status indication : When the battery is disconnected from the equipment or is out of order, the image below is displayed.



6-3. When to Replace the Battery

WARNING : Be sure to replace the old battery with a new battery of the same type.

Once you start using the battery, be sure to use it continuously until it is completely discharged.

Frequent charging and discharging shortens the service life of the battery.

Do not use a damaged battery in this device. If the device is supplied with power, the battery will be charged automatically.

6-4. How to Recycle the Battery

When the battery can no longer be recharged, it should be replaced. The battery is recyclable.

Remove the old battery from the monitor and follow your local recycling guidelines.

WARNING : EXPLOSION HAZARD -
DO NOT incinerate the battery or store at high temperature
(may cause serious injury or death).

WARNING : This product contains a chemical known to the State of California to cause cancer, birth defects, or other reproductive harm

7. References and Others

7-1. Cleaning and Maintenance

7-2. Warranty Period

7-3. How to Contact Us

7-1. Cleaning and Maintenance

Check the items below before operating the equipment.

We do not provide free repair even if the warranty is still valid if the product is contaminated or damaged due to the use of non-approved dangerous material for washing.

CAUTION : Do not use acetone or ketone solvents for cleaning; do not use an autoclave or a steam cleaner.

Cables and lead wires can be cleaned with warm, damp cloth and mild soap or isopropyl alcohol wipes. For more intensive disinfecting (near-sterile), Ethylene Oxide (ETO) is acceptable, but it will shorten the service life of the cable or lead wire.

CAUTION : The decision to sterilize must be made as per your institution's requirements with awareness of the effect on the integrity of the cable or lead wire.

Carefully check both frame and sensor after cleaning the Equipment. Do not use worn out or damaged equipment.

Clean and wipe the frame at least once a month using a soft cloth wet with water and alcohol. Do not use lacquer, thinner, ethylene, or oxidizer (may damage the equipment).

Make sure both cables and accessories are free of dust or contaminants; wipe them with soft cloth wet with warm water(40°) and at least once a week. Clean them using clinical alcohol.

7-2. Warranty Period

- This product is manufactured based on – and has passed – strict quality control and thorough inspection.
- The compensation standard concerning repair, replacement, and refund of the product complies with the "Consumer Protection Law" announced by the Economic Planning Dept.
- We Shall repair or replace any part of the Oxy9 wave Vet that is found to be defective under usual operating circumstances for free.
- This warranty does not apply to any defect caused by improper use, misuse, or abuse.

7.3 Federal Communication Commission Interference Statement

This equipment has been tested and found to comply with the limits for a Class B digital device, pursuant to Part 15 of the FCC Rules. These limits are designed to provide reasonable protection against harmful interference in a residential installation. This equipment generates, uses and can radiate radio frequency energy and, if not installed and used in accordance with the instructions, may cause harmful interference to radio communications. However, there is no guarantee that interference will not occur in a particular installation. If this equipment does cause harmful interference to radio or television reception, which can be determined by turning the equipment off and on, the user is encouraged to try to correct the interference by one of the following measures:

- Reorient or relocate the receiving antenna.
- Increase the separation between the equipment and receiver.
- Connect the equipment into an outlet on a circuit different from that to which the receiver is connected.
- Consult the dealer or an experienced radio/TV technician for help.

FCC Caution

Any changes or modifications not expressly approved by the party responsible for compliance could void the user's authority to operate this equipment.

This device complies with Part 15 of the FCC Rules. Operation is subject to the following two conditions:

- (1) This device may not cause harmful interference, and
- (2) this device must accept any interference received, including interference that may cause undesired operation.

IMPORTANT NOTE:

FCC Radiation Exposure Statement

This equipment complies with FCC radiation exposure limits set forth for an uncontrolled environment. This equipment should be installed and operated with minimum distance 20cm between the radiator & your body.

This device and its antenna(s) must not be co-located or operation in conjunction with any other antenna or transmitter.

7-4 IC Notice

- Contains IC : 30025-BOTNLE521

This Class A digital apparatus complies with Canadian ICES-003.

This device complies with Industry Canada licence-exempt RSS standard(s). Operation is subject to the following two conditions: (1) this device may not cause interference, and (2) this device must accept any interference, including interference that may cause undesired operation of the device.

Le present appareil est conforme aux CNR d'Industrie Canada applicables aux appareils radio exempts de licence. L'exploitation est autorisee aux deux conditions suivantes: (1) l'appareil ne doit pas produire de brouillage, et (2) l'utilisateur de l'appareil doit accepter tout brouillage radioelectrique subi, meme si le brouillage est susceptible d'en compromettre le fonctionnement.

7-5. How to Contact Us

If you have any questions or comments relating to our products or purchasing, please contact the telephone numbers or E-mail below. You can talk to our sales people. Bionet always welcomes your enquiries. Please contact us.

Headquarters &

International

Sales & Service

Bionet Co., Ltd.:

5F, 61 Digital-ro 31 gil, Guro-gu, SEOUL

08375, REPUBLIC OF KOREA

Tel : +82-2-6292-6410 / Fax : +82-2-6499-7789

E-mail : service@ebionet.com

Website: www.ebionet.com

U.S.A

Sales & Service

Representative

Bionet America, Inc.

2691 Dow Ave. Suite B

Tustin, CA 92780

Toll Free : 1-877-924-6638 / Fax : 1-714-734-1761

E-mail : support@bionetus.com

Website: www.bionetus.com

European

Sales & Service

Representative

Bionet Europe GmbH :

2Li Bessemerstr. 51,

D-12103 Berlin, Germany

Tel : +49-30-240-374-52

E-mail : bionetEU@ebionet.com

Website: www.bioneteu.com

※ In the event of a malfunction or failure, contact Service Dept. Of Bionet Co., Ltd. along with the model name, serial number, date of purchase and explanation of failure.



PRODUCT WARRANTY



■ Product Name	:	PULSE OXIMETER
■ Model Name	:	Oxy9Wave Vet
■ Approval Number	:	
■ Approval Date	:	
■ Serial Number	:	
■ Warranty Period	:	2 years (USA, Canada, Europe), 1 year (other countries)
■ Date of Purchase	:	
■ Customer Section		
		※ Hospital Name :
		※ Address :
		※ Name :
		※ Phone :
■ Distributor :		
■ Manufacture :		

Thank you for purchasing Oxy9Wave Vet

This product is manufactured based on – and has passed – strict quality control and through inspection.

memo



Headquarters & International Sales & service

Bionet Co., Ltd.:

5F, 61 Digital-ro 31 gil, Guro-gu, SEOUL

08375, REPUBLIC OF KOREA

Tel: +82-2-6292-6410 / Fax: +82-2-6499-7789 / E-mail: service@ebionet.com

Website: www.ebionet.com

U.S.A sales & service representative

Bionet America, Inc.:

2691, Dow Ave, Suite B

Tustin, CA92780 U.S.A.

Toll Free: 1-877-924-6638 / Fax: 1-714-734-1761 / E-mail: support@bionetus.com

Website: www.bionetus.com

European sales & service representative

Bionet Europe GmbH

2Li Bessemerstr. 51,

D-12103 Berlin, Germany

Tel: +49-30-240-374-52 / E-mail: bionetEU@ebionet.com

Website: www.bioneteu.com

BIONET CO., LTD.

Model Name: Oxy9Wave Vet