

# Cardio7e/ Cardio7 (ECG) Operation Manual

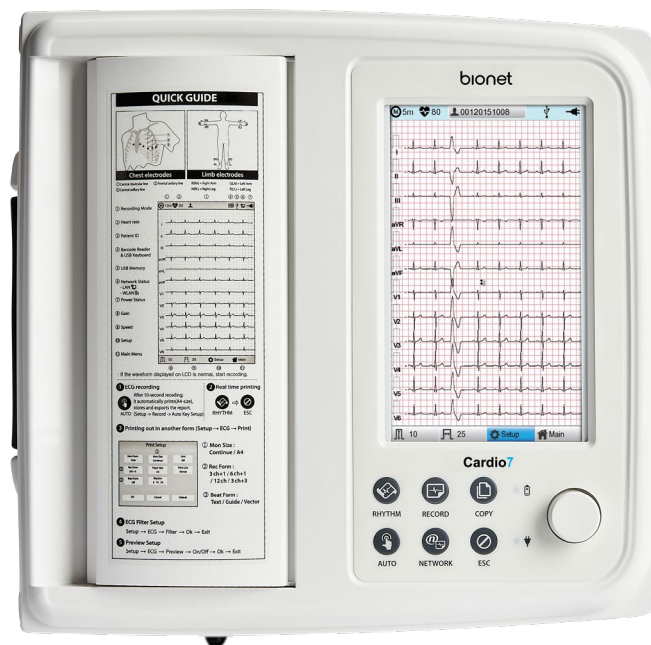

Ver. 1.36

2023.05.18



---

# Warranty

- This product was made through strict quality control and examination. The repair and compensation standards follow the consumer damage compensation regulations of the Ministry of Finance and Economy.

- The warranty for this product runs for 1 year. (2 years in EU) But the warranty for accessories runs for 6 months.

- This product is guaranteed against faulty workmanship for a period of 1 year. Under this warranty, we undertake to repair free of charge at our service centers.

- When having troubles during this period, please provide us with the model name, serial number, date of purchase and a description of the problem you are experiencing.

Caution
Federal law restricts this device to sale by or on the order of a physician

---

## Contact Bionet

If you have any questions or comments relating to our products or purchasing, please contact the telephone numbers or E-mail below. You can talk to our sales people. Bionet always welcomes your enquiries. Please contact us.

---

**Headquarters &  
International  
Sales & service****Bionet Co., Ltd.:**

5F, 61 Digital-ro 31 gil, Guro-gu, SEOUL  
08375, REPUBLIC OF KOREA  
Tel : +82-2-6292-6410 / Fax : +82-2-6499-7789  
E-mail : [sales@ebionet.com](mailto:sales@ebionet.com)  
Website: [www.ebionet.com](http://www.ebionet.com)

---

**U.S.A  
sales & service  
representative****Bionet America, Inc.:**

2691, Dow Ave, Suite B  
Tustin, CA 92780 U.S.A.  
Toll Free : 1-877-924-6638 / Fax : 1-714-734-1761  
E-mail : [support@bionetus.com](mailto:support@bionetus.com)  
Website: [www.bionetus.com](http://www.bionetus.com)

---

**European  
sales & service  
representative****Bionet Europe GmbH :**

2Li Bessemerstr. 51,  
D-12103 Berlin, Germany  
Tel : +49-30-240-374-52  
E-mail : [bionetEU@ebionet.com](mailto:bionetEU@ebionet.com)  
Website: [www.ebionet.com](http://www.ebionet.com)

---

Leg  
E

---

※ In the event of a malfunction or failure, contact Service Dept. Of Bionet Co., Ltd. along with the model name, serial number, date of purchase and explanation of failure.

※ 'CE1434' only supports Cardio7e equipment.

## Fee-Based Service

**If you wish to make a claim when the product is damaged through misuse, we charge repair fees. Please read the manual before you make a claim.**

<ul style="list-style-type: none"> <li>- For simple inspection without giving instruction or disassembling the product</li> <li>- For reinstalling due to poor installation by the retailer</li> </ul>	<p style="text-align: center;">Fee charged: From the second time Free of charge: One time</p>
<ul style="list-style-type: none"> <li>- For poor installation due to moving</li> <li>- For reinstallation after initial installation due to customer's requirements.</li> <li>- For reinstallation due to customer's unskilled installation</li> <li>- For offering service when a foreign substance is introduced or mis-cleaned by the customer</li> </ul>	<p style="text-align: center;">Fee charged</p>

### **1. The warranty does not cover cleaning, adjusting and instruction for use.**

(Separate standard will apply when repair is impossible)

### **2. Fault of customer**

When the product is damaged or broken due to customer's improper use or misuse

- When the power cord is replaced improperly by the user
- When the user drops the product while moving, after the initial installation
- When the user uses unauthorized accessories
- When the product is repaired by unauthorized person

### **3. Others**

- When the product is damaged by a natural disaster (fire, flood or earthquake)
- When lifespan of accessories ends

## Definition of WARNING, CAUTIONS and NOTE

- In order to stress the contents of this manual, we define the terms as below. Please follow the warning and cautions instruction.
- The manufacturer or service agents are not responsible for damage resulting from inappropriate use or carelessness.

### WARNING

There may be serious injuries, fatal accidents or financial damages if you violate this instruction

### CAUTIONS





There may be slight injuries or reduced damages if you violate this instruction

### NOTE

There may not be any dangerous events, but it is important to note this instruction for installation, use, maintenance or repair

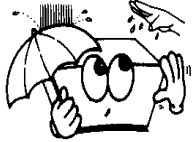
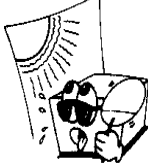
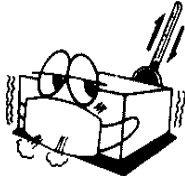
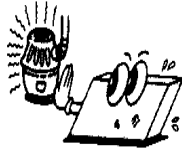
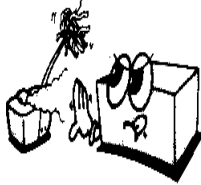
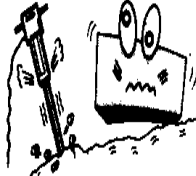
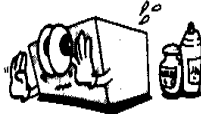
## Environment Instructions

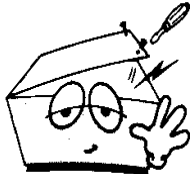
- Please do NOT use or place the product in such environments explained below.

	<p>Steamy environment. Do not use the product with wet hands.</p>		<p>Direct sunlight.</p>
	<p>Place where the temperature and humidity condition are extreme (Use the equipment between the ambient temperature 10 to 40°C (50 to 104°F) and humidity 30 to 85%.)</p>		<p>Near electronic heaters</p>
	<p>High humidity or ill-ventilated place</p>		<p>Place where excessive shock or vibration may occur</p>
	<p>Place exposed to flammable chemicals or explosive gas.</p>		<p>Never introduce dust or metal into the product.</p>
	<p>Do not disassemble the product. The product does not cover problems resulting from disassembling the product.</p>		<p>Do not plug the power supply cord before installing the product completely. It may cause damage to the product.</p>

## Safety Instructions for Electricity

### Please note the following precautions before using the product.

- Is the power supply cord proper? (100 - 240V AC)
- Is every cord connected properly to the product?
- Is the grounding connected correctly? (Otherwise, noise can occur.)
- There is a risk of electric shock if the Rest stand of the equipment is damaged or can not be fixed to the product. Do not use the product and immediately ask the manufacturer and the seller for repair

### Classification.

- This device is classified as follows, in accordance with IEC60601-1.
- Its classification against electric shocks is Class I , Type CF defibrillation -proof applied part.
- Degree of protection against harmful ingress of water: Ordinary
- It is not proper to use this product near a flammable anesthetic or solvent.
- Continuous operation.
- IEC/EN60601-1-2 (Electromagnetic Compatibility Requirements) standard:

Classification	Description
Class A	The device or system is suitable for use in all establishments other than domestic and those directly connected to the public low-voltage power-supply network that supplies buildings used for domestic purposes. Mains power should be a typical commercial or hospital environment.

#### NOTE

Diagnosis provided by Cardio7e/Cardio7 must be confirmed by a qualified medical professional.

#### NOTE

The EMISSIONS characteristics of this equipment make it suitable for use in industrial areas and hospitals (CISPR 11 class A). If it is used in a residential environment (for which CISPR 11 class B is normally required) this equipment might not offer adequate protection to radio-frequency communication services. The user might need to take mitigation measures, such as relocating or re-orienting the equipment.

---

## Safety Messages

The following messages apply to the product as a whole. Specific messages may also appear elsewhere in the manual.

**WARNING:**

ACCIDENTAL SPILLS — If liquids enter a device, take the device out of service and have it checked by a service technician before it is used again.

To avoid electric shock or device malfunction, liquids must not be allowed to enter the device.

**WARNING:**

BATTERY OPERATION — If the integrity of the electrical ground is in doubt, operate the unit from its battery.

**WARNING:**

CABLES — To avoid possible strangulation, route all cables away from the patient's throat.

**WARNING:**

CONNECTION TO MAINS — This is class I equipment.

The mains plug must be connected to an appropriate power supply.

**WARNING:**

DEFIBRILLATOR PRECAUTIONS — Do not come into contact with patients during defibrillation.

Otherwise, serious injury or death could result.

Patient signal inputs labeled with the CF symbols with paddles are protected against damage resulting from defibrillation voltages.

To ensure proper defibrillation protection, use only the recommended cables and lead-wires.

Proper placement of defibrillator paddles in relation to the electrodes is required to ensure successful defibrillation.

**WARNING:**

ELECTRODES — Polarizing electrodes (stainless steel or silver constructed) may cause the electrodes to retain a residual charge after defibrillation. A residual charge will block acquisition of the ECG signal.

Whenever patient defibrillation is a possibility, use non-polarizing electrodes (silver or silver chloride construction) for ECG monitoring.

**WARNING:**

MAGNETIC AND ELECTRICAL INTERFERENCE — Magnetic and electrical fields are capable of interfering with the proper performance of the device.

For this reason, make sure that all external devices operated in the vicinity of the device comply with the relevant EMC requirements. X-ray equipment or MRI devices are possible sources of interference as they may emit higher levels of electromagnetic radiation.

Use of this equipment adjacent to or stacked with other equipment should be avoided because it could result in improper operation. If such use is necessary, this equipment and the other equipment should be observed to verify that they are operating normally.

**WARNING:**

EXPLOSION HAZARD — Do NOT use in the presence of flammable vapors or liquids.

**WARNING:**

INTERPRETATION HAZARD — Computerized interpretation is only significant when used in conjunction with clinical findings.

A qualified physician must verify all computer-generated diagnoses.

**WARNING:**

OPERATOR — Medical technical equipment such as this system must be used only by qualified and trained personnel.

**WARNING:**

**SHOCK HAZARD** — Improper use of this device presents a shock hazard. Strictly observe the following guidelines. Failure to do so may endanger the lives of the patient, user, and bystanders.

When disconnecting the device from the power line, remove the plug from the wall outlet before disconnecting the cable from the device; otherwise, there is a risk of coming into contact with line voltage by inadvertently introducing metal parts in the sockets of the power cord.

Additional equipment connected to medical electrical equipment must comply with the respective IEC or ISO standards (e.g. IEC 60950 for data processing equipment). Furthermore all configurations shall comply with the requirements for medical electrical systems (see IEC 60601-1-1 or clause 16 of the 3 Ed. of IEC 60601-1, respectively). Anybody connecting additional equipment to medical electrical equipment configures a medical system and is therefore responsible that the system complies with the requirements for medical electrical systems.

Attention is drawn to the fact that local laws take priority over the above-mentioned requirements.

If in doubt, consult your local representative or the technical service department.

**WARNING:**

**SITE REQUIREMENTS** — Improper placement of the device and/or accessories may result in a hazard to the patient, operator, or bystanders.

Do not route cables in a way that they may present a stumbling hazard.

For safety reasons, all connectors for patient cables and lead-wires are designed to prevent inadvertent disconnection, should someone pull on them.

For devices installed above the patient, adequate precautions must be taken to prevent them from dropping on the patient.

**WARNING:**

**TREADMILLS** — Avoid rapid changes in treadmill speed and/or grade during a stress test.

**CAUTION:**

**PROPER LEADWIRE CONNECTION** — Improper connection will cause inaccuracies in the ECG.

Trace each individual lead-wire from its acquisition module label to the colored connector and then to the proper electrode to ensure that it is matched to the correct label location.

**CAUTION:**

**ACCESSORIES (SUPPLIES)** — Parts and accessories used must meet the requirements of the applicable IEC 60601 series safety standards and essential performance standards, and/or the system configuration must meet the requirements of the IEC 60601-1-1 medical electrical systems standards.

Use of accessories, transducers and cables other than those specified or provided by the manufacturer of this equipment could result in increased electromagnetic emissions or decreased electromagnetic immunity of this equipment and result in improper operation.

**CAUTION:**

**ACCESSORIES (EQUIPMENT)** — The use of accessory equipment that does not comply with the equivalent safety requirements of this equipment may lead to a reduced level of safety of the resulting system.

Consideration relating to the choice of equipment shall include:

- Use of the accessory in the patient vicinity, and Evidence that the safety certification of the accessory has been performed in accordance with the appropriate IEC 60601-1 and/or IEC 60601-1-1 harmonized national standard.

**CAUTION:**

**BATTERY POWER** — If a device equipped with an optional battery pack will not be used or connected to the power line for a period of over six months, remove the battery.

**CAUTION:**

BEFORE INSTALLATION — Compatibility is critical to safe and effective use of this device. Please contact your local sales or service representative prior to installation to verify equipment compatibility.

**CAUTION:**

DISPOSABLES — Disposable devices are intended for single use only. They should not be reused as performance may degrade or contamination could occur.

**CAUTION:**

DISPOSAL — At the end of its service life, the product described in this manual, as well as its accessories, must be disposed of in compliance with local, state, or federal guidelines regulating the disposal of such products.

If you have questions concerning the disposal of the product, please contact bionet or its representative.

**CAUTION:**

EQUIPMENT DAMAGE — Devices intended for emergency application must not be exposed to low temperatures during storage and transport to avoid moisture condensation at the application site.

Wait until all moisture has vaporized before using the device.

Portable RF communications equipment (including peripherals such as antenna cables and external antennas) should be used no closer than 30 cm (12 inches) to any part of the , including cables specified by the manufacturer.

**CAUTION:**

ELECTRIC SHOCK — To reduce the risk of electric shock, do not remove cover or back. Refer servicing to qualified personnel.

**CAUTION:**

OPERATOR — Medical technical equipment such as this electrocardiograph system must only be used by persons who have received adequate training in the use of such equipment and who are capable of applying it properly.

**CAUTION:**

POWER REQUIREMENTS — Before connecting the device to the power line, check that the voltage and frequency ratings of the power line are the same as those indicated on the unit's label. If this is not the case, do not connect the system to the power line until you adjust the unit to match the power source.

In the USA, if the installation of this equipment will use 240V instead of 120V, the source must be center tapped, 240V single-phase circuit.

This equipment is suitable for connection to public mains as defined in CISPR 11.

Equipment connected to the ECG system and in the patient, environment must be powered from a medically isolated power source or must be a medically isolated device. Equipment powered from a non-isolated source can result in chassis leakage currents exceeding safe levels. Chassis leakage current created by an accessory or device connected to a non-isolated outlet may add to the chassis leakage current of the ECG system.

**CAUTION:**











SERVICEABLE PARTS — This equipment contains no user serviceable parts.





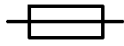

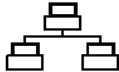

Refer servicing to qualified service personnel.

**CAUTION:**

SUPERVISED USE — This equipment is intended for use under the direct supervision of a licensed health care practitioner.

## Safety Symbols

Symbols	Contents
	ATTENTION: Consult accompanying documents
	Consult instructions for use: This symbol advises the reader to consult the operating instructions for information needed for the proper use of the device.
	Safety Sign: To signify that the instruction manual must be read. Reading the instruction manual before starting work or before operating equipment.
	General prohibition sign
	Defibrillation –proof type CF APPLIED PART
	Type B APPLIED PART
	Alternating Current Power
	Fuse
	Conductor provides a connection between equipment and the potential equalization bus bar of the electrical installation
	ECG Patient Cable Connector
	USB Connector

Symbols	Contents
	Spirometry Connector
	Local Area Network (LAN) Connector
	Power Off
	Power On
	Battery Operation Indicator
	AC Power Connection Indicator
	Manufacturer name and address
	Authorized European representative
	Waste of electrical and electronic equipment must not be disposed as unsorted municipal waste and must be collected separately. Please contact an authorized representative of the manufacturer for information concerning the decommissioning of your equipment.

---

# Contents

<b>Chapter 1. General Information .....</b>	<b>16</b>
1) Product Overview .....	17
2) Indication for use .....	17
3) Recording ECGs During Defibrillation .....	18
4) Product Features .....	18
5) Product Configuration .....	19
6) System Installation .....	32
7) System Start.....	35
<b>Chapter 2. Preparation for Electrocardiography .....</b>	<b>41</b>
1) Location of Electrodes.....	42
2) Electrode Connection .....	43
3) Starting ECG recording.....	45
4) Basic Setup .....	46
5) LCD Monitor display .....	57
6) Disclosure .....	58
7) Rhythm Mode Printing.....	59
8) Record Mode Printing .....	60
9) Printing Form.....	61
10) Copy Mode Printing .....	71
11) System Setup.....	73
<b>Chapter 3. ECG file management .....</b>	<b>138</b>
1) Display and function .....	139
2) Data printing.....	140
3) Data deleting .....	141
4) System Setup .....	142
5) Switching menu .....	145

---

6) Patient information .....	146
7) Data search .....	147
8) Data transfer .....	148
9) Data import .....	150
<b>Chapter 4. ECG worklist management .....</b>	<b>153</b>
1) Display and function .....	154
2) ECG Test .....	155
3) Data deleting .....	156
4) System Setup .....	157
5) Switching menu .....	158
6) Patient information .....	158
7) Data search .....	159
<b>Chapter 5. System Management .....</b>	<b>160</b>
1) Maintenance and Cleaning .....	161
2) Regular Check-up .....	162
3) Trouble Shooting .....	162
4) Manufacturer Declaration .....	166
<b>Chapter 6. Specification .....</b>	<b>172</b>

## Chapter 1. General Information

### 1) Product Overview

### 2) Indications for use

### 3) Recording ECGs During Defibrillation

### 4) Product Features

### 5) Product Configuration

- Basic Components and Accessories

- Optional components

- Body Configuration

- Front Panel

- Graphic display LCD

- Control Panel

- Power

### 6) System Installation

- Precautions for Installation

- Power Connection

- Patient Cable Connection

- Paper Installation

### 7) System Start

## 1) Product Overview

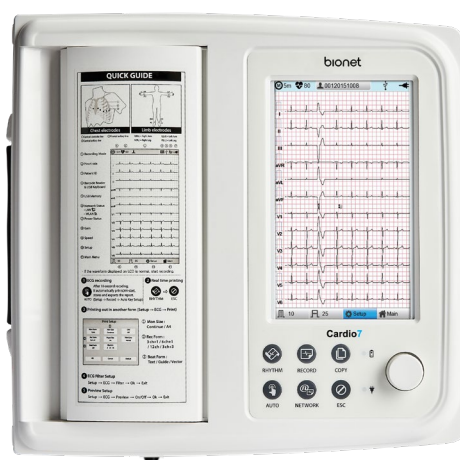

Cardio7e/Cardio7 is an electrocardiogram (ECG) device capable of measuring and recording 12 channels of cardiac signals of patients. The device enables operators to record cardiac signals, review them using various viewing modes, and perform automatic detection of cardiac conditions.

In addition, the device allows operators to enter patient information for it to be printed alongside cardiac signals, so that operators can sort and manage charts conveniently. It is also possible to manage the digital files by transferring the stored data to a networked PC.

Furthermore, user convenience has been further enhanced by addition of a functionality that can initiate ECG recording & saving, filter enhancing, parameter sorting and automatically detecting cardiac signal all at once by pressing one key.

A battery (optional) can be added to the device so that the device can be operated conveniently during bedside visits or emergency conditions.

## 2) Indication for use

The Cardio7e/Cardio7 ECG Analysis System is intended to acquire, analyze, display and record electrocardiographic information from adult and pediatric populations.

Basic systems deliver 12 lead ECG's, interpretive analysis, vector loops, and can be upgraded to provide software analysis options such as high-resolution signal averaging of QRS and P wave portions of the electrocardiogram. Transmission and reception of ECG data to and from a central ECG cardiovascular information system is optional.

The Cardio7e/Cardio7 is intended to be used under the direct supervision of a licensed healthcare practitioner, by trained operators in a hospital or medical professional's facility.

### Indications

The ECG has proven to be among the most useful diagnostic tests in clinical medicine. The ECG is now routine in the evaluation of patients with implanted defibrillators and pacemakers, as well as to detect myocardial injury, ischemia, and the presence of prior infarction as well. In addition to its usefulness in ischemic coronary disease, the ECG, in conjunction with ambulatory ECG monitoring, is of particular use in the diagnosis of disorders of the cardiac rhythm and the evaluation of syncope.

### Contraindications

No absolute contraindications to performing an electrocardiogram, other than patient refusal, exist. Some patients may have allergies, or more commonly, sensitivities to the adhesive used to affix the leads; in these cases, hypoallergenic alternatives are available from various manufacturers.

## 3) Recording ECGs During Defibrillation

This equipment is protected against the effects of cardiac defibrillator discharge to ensure recovery, as required by test standards. The patient signal input of the acquisition module is defibrillation-proof. Therefore, it is not necessary to remove the ECG electrodes prior to defibrillation.

When using stainless steel or silver electrodes a defibrillator discharge current may cause the electrodes to retain a residual charge causing a polarization or dc offset voltage. This electrode polarization will block acquisition of the ECG signal. To avoid this condition, use non-polarizing electrodes (which will not form a dc offset voltage when subjected to a dc current) such as silver/silver-chloride types if there is a situation where there is a likelihood that a defibrillation procedure will be necessary.

If polarizing electrodes are used, we recommend disconnecting the lead-wires from the patient before delivering the shock.

Electrode defibrillation recovery is the ability of the electrode to allow the ECG trace to return after defibrillation. We recommend using non-polarizing disposable electrodes with defibrillation recovery ratings as specified in AAMI EC12 4.2.2.4. AAMI EC12 requires that the polarization potential of an electrode pair does not exceed 100mV, 5 seconds after a defibrillation discharge.

## 4) Product Features

- Print 12-channel (ch) cardiac signals with reports in: 3ch+1 rhythm, 3ch+3 rhythms, 6ch+1 rhythm, and 12ch rhythm patterns on A4 or Letter size printing paper.
- Record a rhythm from 1 channel for an extended time (1 minutes, 5 minutes, 10 minutes) then print it on A4 or Letter size printing paper.
- Record and print 12 channel rhythms continuously and simultaneously.
- Calculate heart rate, P-R-T axis and PR, RR, QRS, QT and QTc widths and SV1/RV1/R+S volumes from recorded signals automatically and print them on a report for use in rhythm analysis.
- Get diagnostic reports using automatic detection functionality about Neonatal, pediatric, adult.
- Able to modify filter setting, signal sensitivity, printing speed, channel view settings and rhythm settings, and print on previously recorded EKG signals to aid data analysis.
- Able to attach a battery so that the device can become portable.
- Manage chart effectively by addition of patient and operator data on EKG printout.
- More than 200 patient's data can be saved and transferred to a PC through LAN as well as through USB Memory.
- It offers various protocols to make it possible to link with hospitals' computing networks. Also, File and worklist Databases are strengthened.

## 5) Product Configuration

The Cardio7e/Cardio7 system consists of the items below. Unpack the package and check the items below are included. Also, be sure to check for any damage to the body and accessories.

### Basic Components and Accessories



- ① Cardio7e/Cardio7 body (1 EA) - Dimension 300(W) x 290(D) x 89.5(H) mm
- ② Patient cable (1 EA)- Length 3,700mm (Max)
- ③ Limb electrodes (1 SET)
- ④ Chest electrodes (1 SET)
- ⑤ ECG paper (1 EA)
- ⑥ Power cable (1 EA)- Length 2,500mm (Max)
- ⑦ ECG Gel (1 EA)

#### NOTE

The model Cardio7e/Cardio7 only provides the ECG function as part of the Cardio7 products.

## Optional components

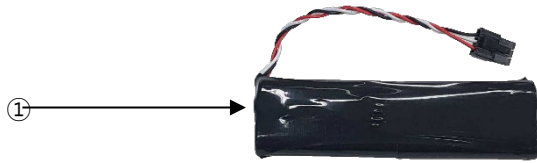

① Battery (1 EA)

### Caution

You may have distortion or signal noise when you use nonstandard or other brand accessories. We strongly recommend you use only the authorized accessories which we supply.

### WARNING

If the battery provided by us is not used, we are not responsible for any problems arising from it. Be sure to use the battery provided by our company.

## Body Configuration

### ■ Top View

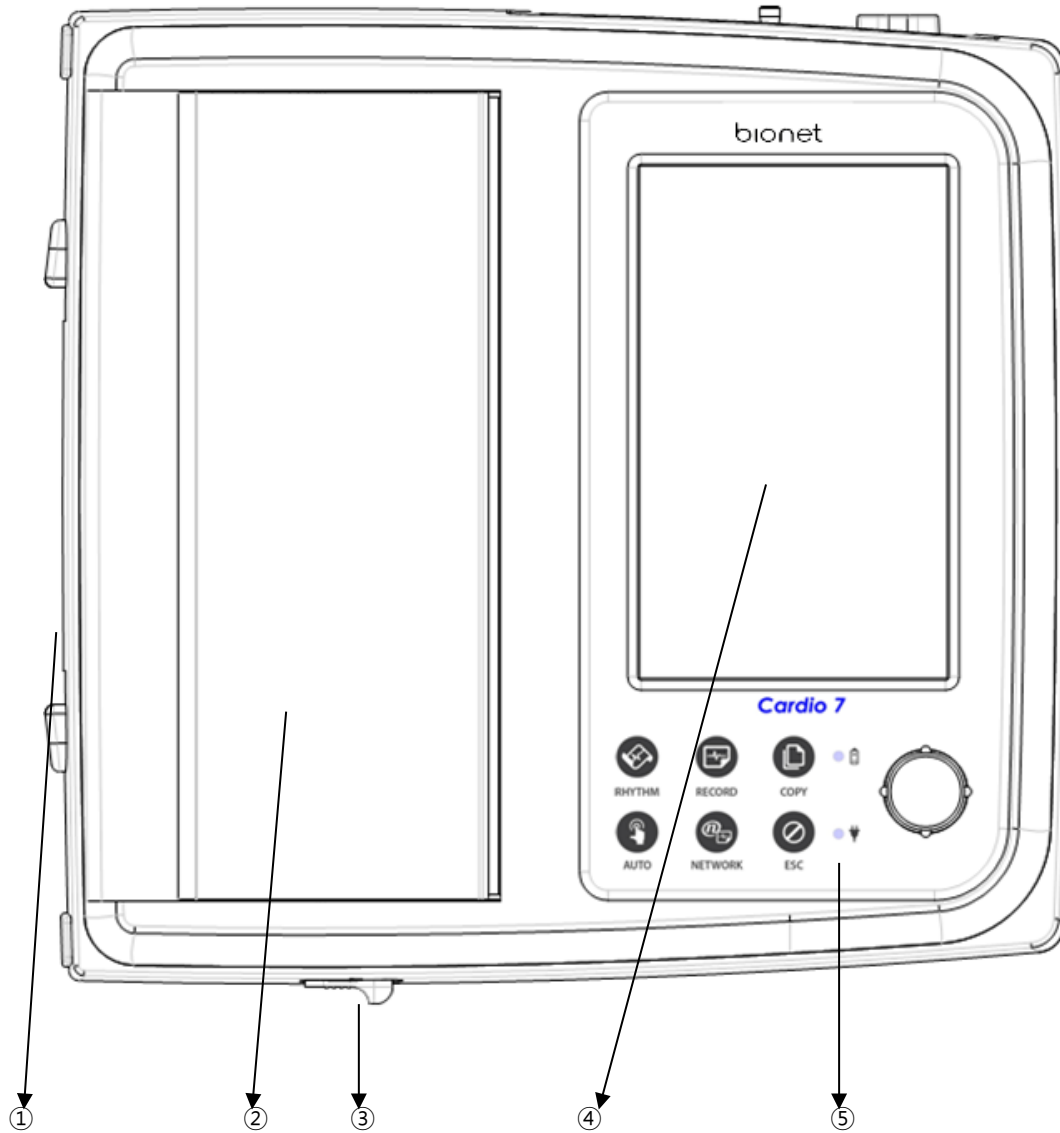

- ① Handle
- ② Printer Cover
- ③ Printer Cover Switch
- ④ LCD
- ⑤ Control Panel

■ Front View

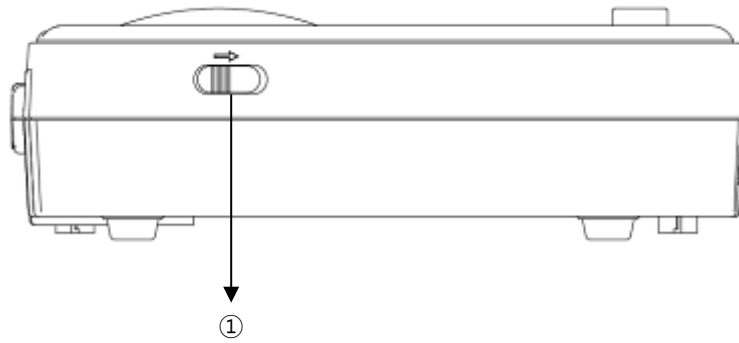

① Printer Cover Switch

## ■Rear View

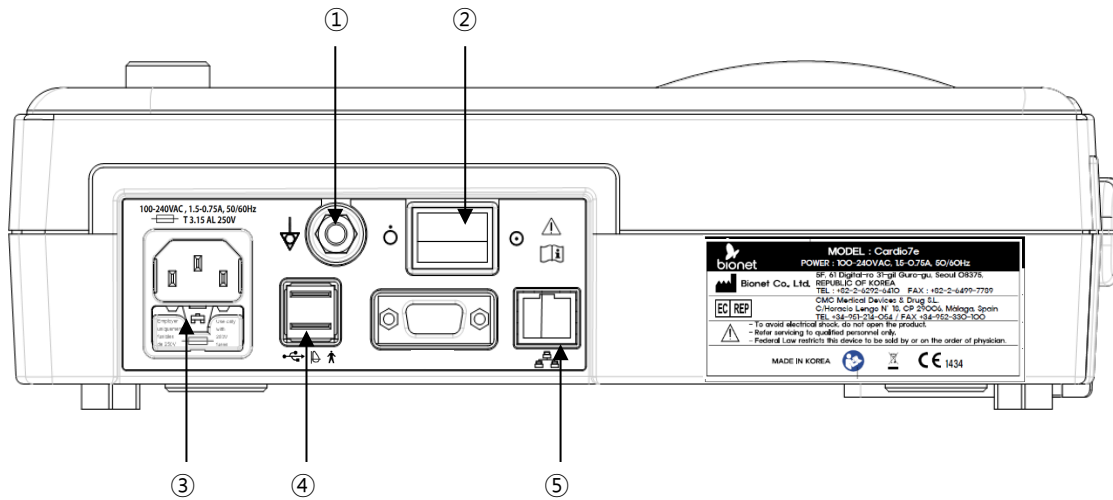

- ① Protective Ground Terminal
- ② Power Switch
- ③ AC Power Connection Port (+ Fuse (250V, 3.15AL) x 2)
- ④ USB Port
- ⑤ RJ45 LAN Port

### NOTE

Appliance inlet of separate power supply unit is used as mains disconnecting device.

### NOTE

For Cardio7, the following label is attached.



## ■ Left Side View

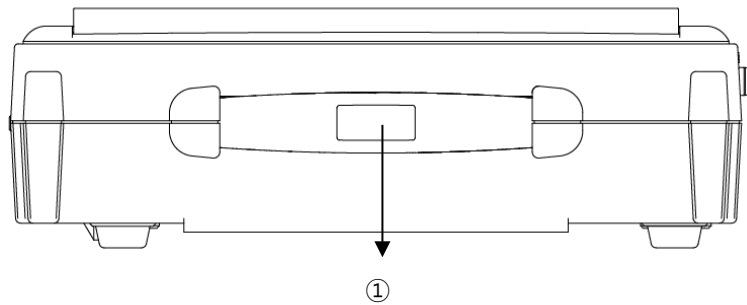

## ① Handle

## ■ Right Side View

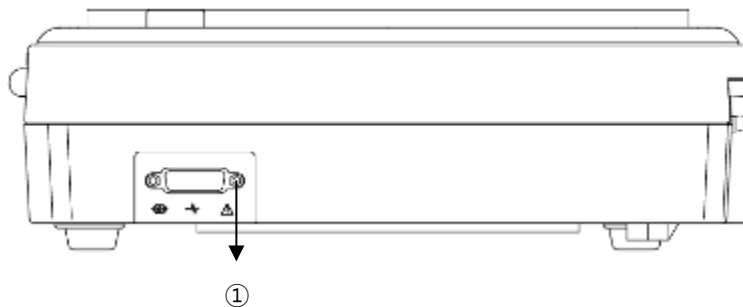

## ① Patient Cable Connection Port

**WARNING**

There is a risk of electric shock if the Rest stand of the equipment is damaged or can not be fixed to the product. Do not use the product and immediately ask the manufacturer and the seller for repair

**NOTE**

To avoid an expected electric shock, do not open the equipment cover or disassemble the equipment. Refer servicing to Bionet, Inc.

**Front Panel**

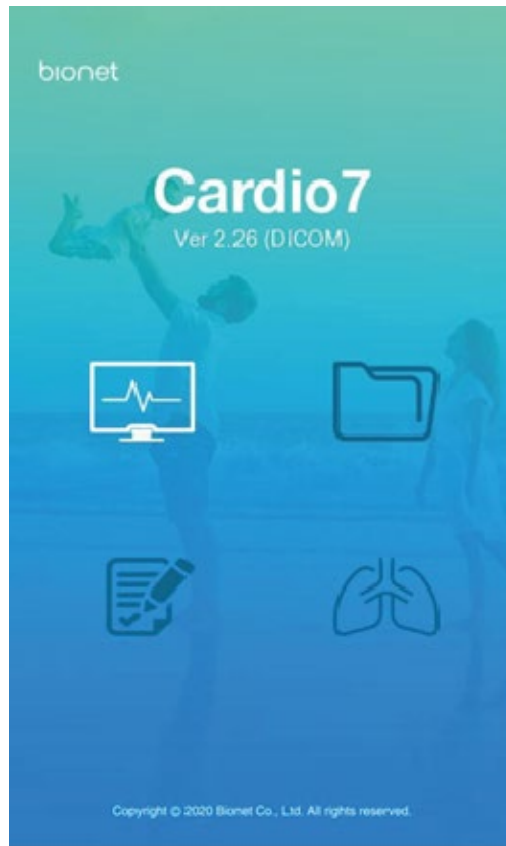

Graphic display window

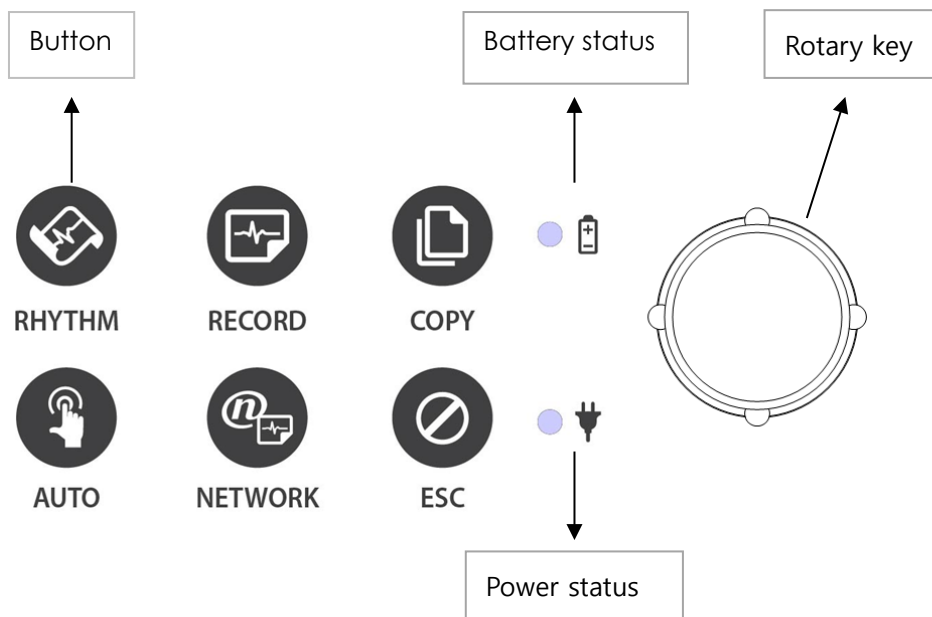

During device boot up, you can see the system software version and the Bionet name.

## Graphic display LCD

The following descriptions explain data on the graphic LCD.

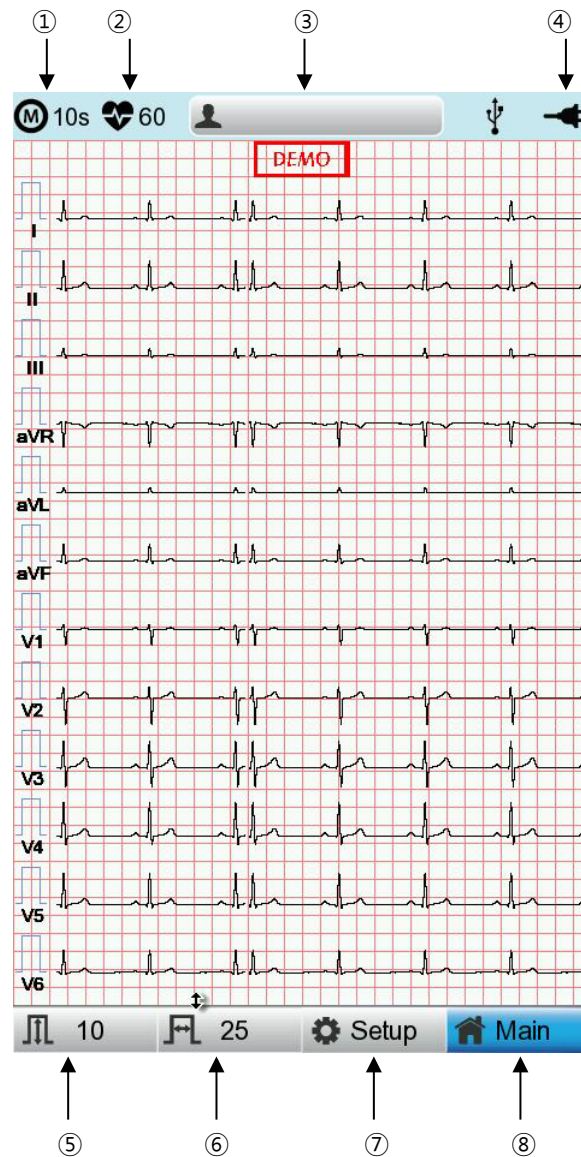

- ① Select one ECG recording mode (10s, 1m, 3m, 5m, or 10m (seconds, minutes))
- ② Displays the Heart Rate.
- ③ Displays Patient ID.
- ④ Displays Battery Status or AC Power Connection Status.
- ⑤ Displays ECG Sensitivity with One of 5, 10, 20, and Auto (mm/mV).
- ⑥ Displays Printing Speed with One Of 5, 12.5, 25, 50 And 100 (mm/sec).
- ⑦ Modify the preferences of 6 items, i.e., Basic Setup, Network Setup, Hospital Setup, ECG Setup, Record Setup and Service Setup
- ⑧ Choose the menu where you want to move (ECG, File, Worklist or Spiro)

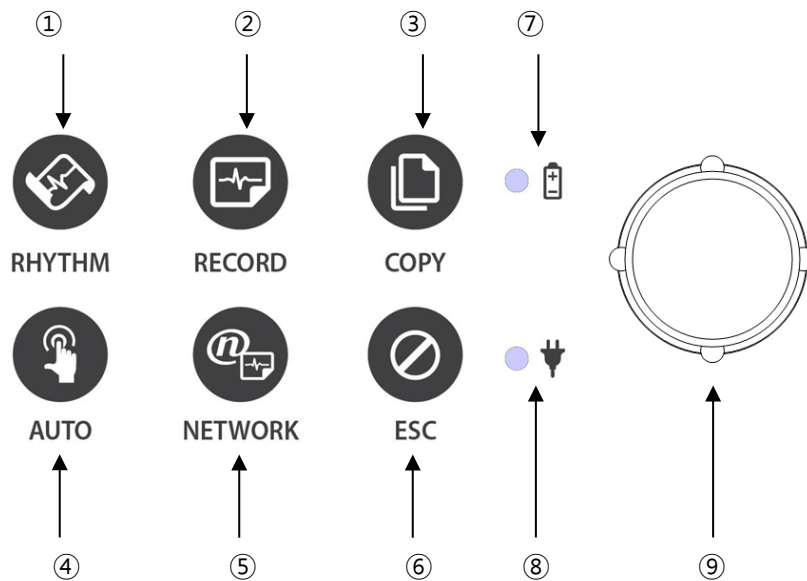

## Control Panel



### ■ Button

①		Print out the rhythm data on A4 size or continuous paper.
②		10sec. and long-term readings (1min., 3min., 5min., 10min.) are saved and are printed as an output form after processing.
③		Process the recorded data with or without revision and print them out.
④		It operates the product in the most frequently used operation from the ECG diagnosis test to data saving.
⑤		It transfers the test data or saved data to the server PC.
⑥		Cancel commands or change into the former mode for main menu printing.

### ■ LED

⑦		A light indicator lets you know that the battery is on and shows your current battery charging status. A red-light indicator lets you know that the battery is charging, and a green light indicator lets you know the batter is fully charged.
⑧		Green light indicates connection with an AC adapter.

### ■ Rotary Switch

⑨		Use when navigating or selecting menu items (Same functionalities can be achieved by touching menu items on the screen).
---	---	---

## Power

### ■ AC Power

When AC Power is connected to the device, power LED light will be green; if the battery is installed, charging will commence.

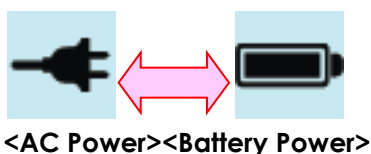

### WARNING

This equipment must be connected to a power supply with a protective earth.

### ■ Battery Power

The device will get its power from the battery and the unit will display the battery power icon (shown above), when the system is powered on, the battery is connected to the device and the AC power is disconnected. When the battery power is low, an alarm sound will ring from the device speaker and LCD display will show a "Battery Low" message. Connect the AC power immediately or the device will automatically shut down in 1minute.

- Time to complete full recharge after full discharge: Max. 3 hours while the power is turned off
- Duration of continuous usage after full recharge: if running ECG record in 12 channel format by choosing to set successive function for about 360 min. at 25mm/s and 10mm/mV or in the absence of ECG record, it is possible to record a max. of 200

ECG.

- Battery Type: Lithium-ion battery

The lithium-ion battery is rechargeable batteries with lithium-ion cells. Each battery cell contains an electrical residual measurement circuit and a safety circuit.

#### WARNING

- The battery charging display will show correctly if the battery is operating normally.
- Old or defective batteries are significantly reduced capacity or operating time





#### NOTE

The battery charging display will take up to 15 seconds to reflect the actual capacity of the internal battery if AC power is not supplied.

#### NOTE

- Bionet recommends replacing the lithium-ion battery after 24 months of use.
  - Battery life depends on usage.
- Continuing battery use will reduce battery life and increase the frequency of replacement.
- Recharge the battery after it is discharged to prevent pre-discharge.

#### ■ Display Battery Power Status

- : Battery Fully Charged
- : Battery Charge Half-Full
- : Battery Charge Low
- : Battery Almost Fully Drained

#### ■ Replacing Battery

When replacing battery for this device, the same type of battery should be used.

- Type: Lithium-ion battery 3BL335-BIO-4(10.8V, 3250mAh)
- When to replace: Battery will automatically be charged when the device is connected to AC power and cannot be charged when separated from the device. Battery is designed to have a charging cycle of 300 times or more. If the device only lasts 20 minutes or less on battery power, the battery needs to be replaced. Additionally, when a battery pack is damaged or leaking chemicals, replace it immediately. Do not use damaged battery packs with the device.

**CAUTIONS**

For the protection of environment, do NOT throw wasted battery away. Please inquire at the biomedical engineering lab of the hospital and dispose according to the appropriate procedure to the authorized place (according to national regulations).

**WARNING**

Take care of the polarity when replacing the battery.  
It is strongly recommended using the battery provided by the Bionet.  
Using non-approved batteries may damage the equipment.

**Effect of Lithium-ion Battery Technology on the Battery**

This is explained about the lithium-ion battery technology.

The battery will discharge itself even though it is not connected to the equipment. Because it is caused by the induced current in a circuit integrated with the lithium-ion battery, which is own properties, it is self-discharged. The self-discharge rate increases by twice every 10°C (18°F) increase in temperature.

Battery retention is more lost in the higher temperatures. Depending on battery life, the volume of the full charge rate may decrease gradually or out of work. As a result, the total amount of charge stored and available is reduced.

**Inspection Instructions**

Ensure battery performance by fully charging and discharging equipment every six months.

**Storage Instructions**

The battery must be stored between 20°C and 25°C (68°F and 77°F) from outside the monitor. If the battery is connected to an AC power source in the system, the battery temperature increases by 15°C to 20°C (59°F to 68°F) at room temperature and it shortens the life of the battery

When AC power is connected in the monitor equipment, the battery doesn't work and doesn't supply power. Battery life may be less than 12 months. Bionet recommends it should be kept separate from the equipment during the moving.

**Battery recycles**

Replace the battery when it is no longer charged. This battery is a regenerative product.

Remove the battery from the system and put it in a separate bin.

**WARNING**

Don't keep at high temperatures or burned of a battery due to there is a risk of explosion.

You can wear serious injuries resulting from the explosion.

Do not use and dispose of the battery if it is damaged, shocked and flooded externally.

## 6) System Installation

### Precautions For Installation

While installing Cardio7e/Cardio7, please pay attention to the following items:

- Use the equipment between the ambient temperature 10 to 40°C (50 to 104°F) and humidity 30 - 85%.
- Check the power cord is properly connected, and the probe carefully handled.
- Do not plug multiple cords in a power outlet.
- Install and operate Cardio7e/Cardio7 unit on a flat surface.
- If you experience noise, ground the device.
- Do not use a power cord that may make a connection noise.
- Device settings will be recorded in the internal memory even when it is off.
- Prevent any shock or excessive force that may cause damage to the device.
- Place the device away from any dust or flammable materials.

### Power Connection

The equipment needs electrical power to operate. Plug in one end of the power cable to wall socket and the other to Cardio7e/Cardio7.

### Patient Cable Connection

- Connect the patient cable to the patient cable connection port on the right side of the body.
- Connect limb electrodes to RL (N), LL (F), RA(R), and LA (L) leads of the patient cable and chest electrodes to V1 (C1), V2 (C2), V3 (C3), V4 (C4), V5 (C5), and V6 (C6), respectively.

### Paper Installation

- Push the printer cover release switch to the right to open the printer door of the Cardio7e/Cardio7. Install EKG paper with the side to be recorded appearing on top. Close the cover to finish the paper installation process.

#### WARNING

Use only those products provided by us for ECG records. Otherwise, the output is in poor condition and may affect the diagnosis during a pseudo-verification. We are not responsible for any problems caused by ignoring them.

**WARNING**

No modification of this equipment is allowed.

Do not modify this equipment without authorization of the manufacturer.

If this equipment is modified, appropriate inspection and testing must be conducted to ensure continued safe use of equipment.

**Network Connection**

- No one other than service personnel can connect this device to the network. Consult with hospital IT staff in advance. It is recommended to follow IEC 80001-1 (Risk management of IT networks connected to medical devices)

**LAN Network**

- LAN networks are usually configured through a star topology. Individual devices can be grouped together via a layer-n-switch. Other data traffic is separated by a separate VLAN network. Configure the device's network settings according to this user guide and network specifications.
- LAN connection specifications are described in the following standard specifications.
  - Wired network: IEEE 802.3
  - Wireless network: IEEE 802.11 (a, b, g, n)
- If the device is used as a layer-2-switch or layer-3-switch, the port settings must be configured on the network switch. "Bionet device" must be configured so that the network settings are compatible with the specifications of the operating organization.
- These devices exchange data with other medical devices over a LAN network. The network must support the following transports and protocols.
  - TCP/IP
  - BROADCAST

**VLAN Network**

- If data is exchanged within a single network, an independent VLAN network must be established for clinical information systems, such as a network dedicated to medical devices in hospitals. In addition, it is necessary to establish a network system that detects and defends against denial-of-service attacks by installing dedicated DDos defense system.

## When using an inappropriate network

- If the network does not meet the requirements, the following situations can occur:

- Without firewall and anti-virus software:
    - Your data is not protected.
    - Data is transmitted in an incomplete state or not transmitted at all.
    - Data may be transmitted to the wrong server.
    - Data may be blocked, forged or damaged.
  
  - in case there is no independent network environment or DDos defense system
- You may be subject to denial of service attacks (DDos). In this case, the device may become slow or may not work properly. In rare cases, the boot may be delayed or repeated reboots may occur.

## 7) System Start

When every preference is set, the company name will be displayed when the switch is turned on, and then after approx. 10 seconds, the initial menu selection will appear on the screen, as shown in the figure below.

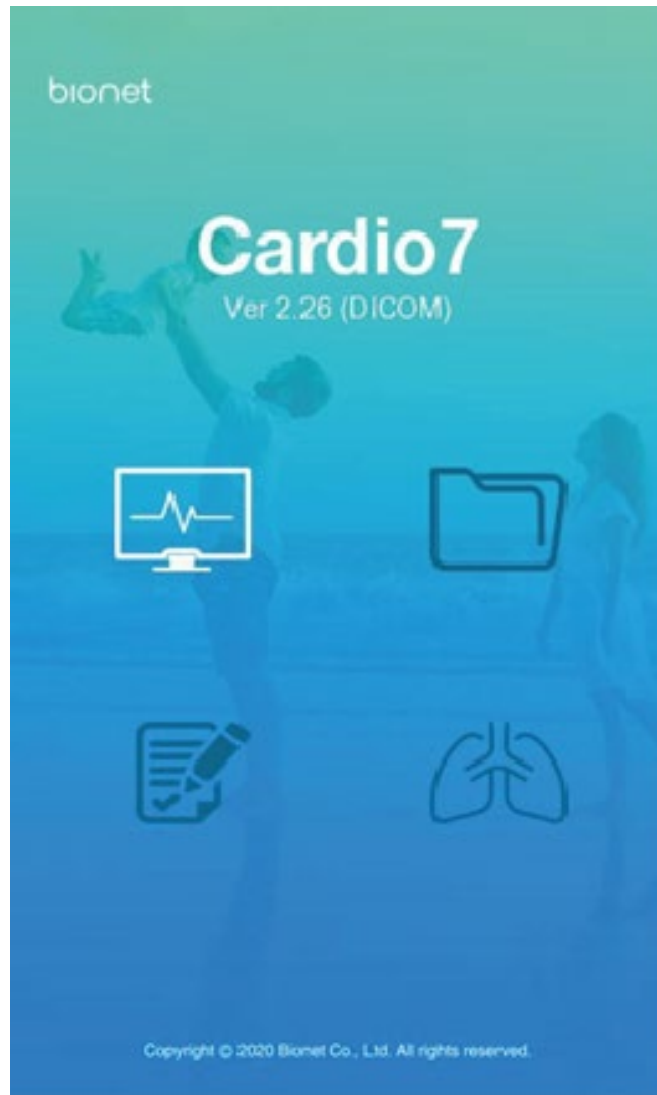





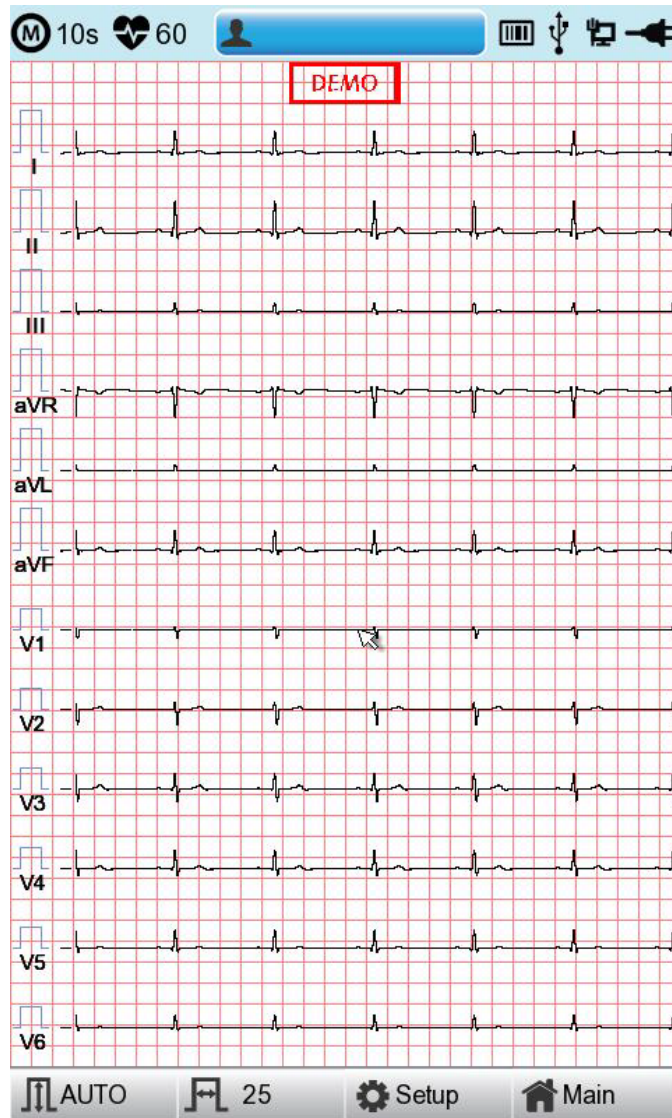







You can move to the main page of the chosen menu by touching the menu on the screen or rotating the key on the control panel.

The following is the main page of ECG menu.



If you remember the information shown below, it will be easier for you to use the main page of ECG.

Menu	Description
	Recording mode (marked as 10 s, 1 m, 3 m, 5 m and 10 m unit)
	Heart rate mark
	To Input or check the patient's information
	Barcode reader or USB Keyboard connection mark
	Replaced by the  icon when a network error occurs during transfer to the PACS server. You can move to the Study Queue screen by touching the  icon.
	USB memory connection mark
	Network status mark (wired:  , wireless :  ).
	Move to the Network Setup screen by touching the icon.  : The error icon will appear in the event of an IP conflict
	Display battery status or AC power connection status
Gain	To set up the size of the ECG waveform
Speed	To set up the speed for printing out the ECG waveform
Setup	To set up the various contents related to the equipment
Main	To skip to main page of ECG File management, ECG worklist management and Spirometer





The following is the main page of ECG file management, shown when selecting the 'File' menu.

No	ID	Name	Age	Date	Study
1	uuj	ryhj	0	20150708	ECG
2	1234		0		ECG
3	234		0		ECG
4	cdee		0	20150512	MVV
5	ddrrg	rdvgy	0	20150512	FVC
6	ed		0	20150512	FVC
7	gjin		0	20150512	ECG
8	ujj		3	20150512	FVC
9	wrtu		0	20150512	FVC
10	1234		0		ECG
11	234		0		ECG
12	cdee		0	20150512	MVV
13	ddrrg	rdvgy	0	20150512	FVC
14	ed		0	20150512	FVC
15	gjin		0	20150512	ECG
16	ujj		3	20150512	FVC
17	wrtu		0	20150512	FVC
18	1234		0		ECG
19	234		0		ECG
20	cdee		0	20150512	MVV
21	ddrrg	rdvgy	0	20150512	FVC
22	ed		0	20150512	FVC
23	gjin		0	20150512	ECG
24	ujj		3	20150512	FVC

File 1/6

Print Delete Setup Main

If you remember the information shown below, it will be easier for you to use the main page of ECG file management.

Menu	Description
File 1/6	Going to Patient List
	To skip to previous page
	To skip to next page
	To check the patient's information
	To search the data by inputting what you want to find
Print	To print out the chosen data
Delete	To delete the chosen or all data
Setup	To set up the various contents related to the equipment
Main	To skip to main page of ECG, ECG worklist management and Spirometer

The following is the main page of ECG worklist management, shown when selecting the 'worklist' menu.

No	ID	Name	Age	Date	Study
1	201507080...	Kim	32	20150708	ECG
2	201507080...	Kim	32	20150708	FVC

If you remember the information shown below, it will be easier for you to use the main page of ECG worklist management.

Menu	Description
Worklist 1/1	Going to Patient List
	To skip to previous page
	To skip to next page
	To check the patient's information
	To search the data by inputting what you want to find
Exam	To start the test with the chosen data
Delete	To delete the chosen or all data
Setup	To set up the various contents related to the equipment
Main	To skip to main page of ECG, ECG worklist management and Spirometer

The following is the initial screen of the Study Queue Data Management, which is where you will navigate to if you select the 'Study Queue' icon () . The Study Queue is managing data errors when an error occurs during transfer to the PACS server.

Study Queue					
Studies : 3					
No	ID	Name	Date	Study	Status
3	11270410	phudg	2015112...	ECG	Ready
2	11275510	gqafb	2015112...	ECG	Ready
1	11275510	gqafb	2015112...	ECG	Ready

Memorizing the following at the Study Queue Management screen will help more convenient use.

Menu	Description
Studies	Number of Study file marks
>>	To skip to previous page
<<	To skip to next page
Delete	To delete the chosen or all data
Retry	Re-transfer selected data or all data
Close	Close window

#### NOTE

-  This icon appears on the top right side when data transport is an error.

---

## Chapter 2. Preparation for Electrocardiography

### 1) Location of Electrodes

### 2) Electrode Connection

Patient Cable Connection

How to Attach Electrodes

Countermeasures for Bad Lead Connection

### 3) Starting ECG recording

### 4) Basic Setup

General

Patient Information Input

Sensitivity Setup

Printing speed Setup

### 5) LCD Monitor display

### 6) Disclosure

### 7) Rhythm Mode Printing

### 8) Record Mode Printing

10 seconds ECG recording

### 9) Printing Form

### 10) Copy Mode Printing

### 11) System Setup

Basic Setup

Network Setup

Hospital Setup

ECG Setup

Record Setup

Service Setup

## 1) Location of Electrodes

Attach electrodes to the patient's body to record an electrocardiogram of twelve standard leads [I, II, III, aVR, aVL, aVF, V1, V2, V3, V4, V5, V6], as shown below.

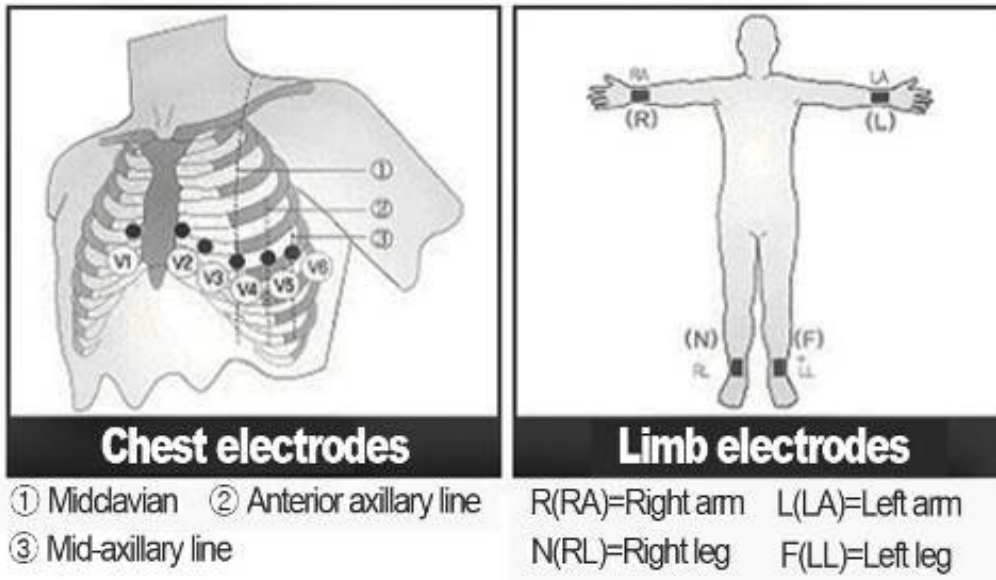

Limb electrodes are located as follows.

- RL (N): Right Leg
- LL (F): Left Leg
- RA (R): Right Arm
- LA (L): Left Arm

Chest electrodes are located as follows.

- V1 (C1): Fourth Intercostal Space at The Right Border of The Sternum
- V2 (C2): Fourth Intercostal Space at The Left Border of Sternum
- V3 (C3): Midway Between Location V2 and V4
- V4 (C4): At the Mid-Clavicular Line in The Fifth Intercostals Space
- V5 (C5): At the Another Axillary Line on The Same Horizontal Level as V4
- V6 (C6): At the Anterior Axillary Line on The Same Horizontal Level as V4 and V5

## 2) Electrode Connection

### \* Check Points

- Check the status of equipment and attachment to patient's body before measuring.
- Check for any mechanical danger.
- Check cables and accessories connected to the outside.
- Check all the devices to measure the patient.

### Patient Cable Connection

Connect the device cable to the patient cable connection port on the right side of the main body, and then connect electrodes for extremities to the terminal of patient cable RL (N), LL (F), RA(R) and LA (L), while you can connect electrodes for the chest to the terminal of 'V1 (C1), V2 (C2), V3 (C3), V4 (C4), V5 (C5) and V6 (C6).

### How to Attach Electrodes

Lay down the patient on the bed and let the patient relax. Attach the electrodes cleaned with water or antiseptic alcohol to the patient's body. If it is hard to attach the electrodes due to the patient's hairs or curves of the body, apply the ECG gel. Please make sure the electrodes are attached correctly as explained above. When using the gel, please remove the gel after use as it may cause noise of the ECG signals.

#### **WARNING**

Use only electrodes and patient cables provided from Bionet, Inc. Bionet America, Inc. will take no responsibility for any accidents involving 3<sup>rd</sup> party accessories.

## Countermeasures for Bad Lead Connection

After turning on the power switch, enter the ECG test to check waveforms of all leads. On this menu, operators can check waveforms of all leads and their noise and may see "Lead Fault" message displayed on the LCD screen.

**Lead Fault! All Leads.**

### NOTE

- Message will be displayed when Lead fault is set to ON in System Setup and will NOT be displayed when set to OFF.
- Please conduct an ECG test with the lead connection is correct.

The following two cases could cause a lead fault error.







- First case, leads are detached from the patient's body. In this case, re-attach leads normally.
- Second case, signal conductivity between leads and the patient's body is low. In this case, replace the electrodes.

If the two above cases have been performed and the operator is still experiencing noise or lead fault conditions, the patient cable may be faulty. Please contact the Bionet service center.

### 3) Starting ECG recording

- Input the patient's information follow the entering procedure.
- Connect leads to the patient with the preparation steps for measuring electrocardiogram.
- Check the setting for filter, size of signals, printing speed, channels and rhythm. Set up the new values if you want to modify them.
- If the waveform displayed on the LCD is abnormal or has excess noise, follow the instruction of "Countermeasures by Bad Lead Connection".
- If the waveform displayed on the LCD is normal, press the 'RECORD' key to record the electrocardiogram of the patient.
- Press the 'COPY' button to print out the previously saved 10-second data or modified data.
- Press the 'RHYTHM' key to monitor the ECG waveform through the printer not through the LCD.
- Press the 'ESC' key to stop the operation while printing or recording.

**The following buttons will be most commonly used when operating Cardio7e/Cardio7.**

	Print out the rhythm data on A4 size or continuous paper.
	10sec. and long-term readings (1min., 3min., 5min., 10min.) are saved and are printed as an output form after processing.
	Process the recorded data with or without revision and print them out.
	It operates the product in the most frequently used operation from the ECG diagnosis test to data saving.
	It transfers the test data or saved data to the server PC.
	Cancel commands or change into the former mode for main menu printing.

## 4) Basic Setup

### General

When turning on the system, it is displayed top and down menu bars and graphic window in the LCD screen.

Top menu bar shows a measurement mode, heart rate, patient information, the status of the external connection and power state in, and down menu bar contains the output speed, size of the signal and setup.

They can be modified in two ways.

These configuration values can be changed using either a rotary key or touch screen. With the rotary key, the desired menu and changed configuration values can be set easily.

Same functionality can also be achieved with the touch screen by pressing and changing the desired information on the LCD.

### Changing the Configuration Value with The Rotary Key

In this case, please follow these steps: enter Menu Mode, navigate and select Menu and then change values.

#### - Entering Menu Mode

The rotary key is supposed to rotate clockwise. When the user selects the ECG Main, the initial focus will point to the 'patient' item.

The following is the page you will see when you rotate the key clockwise and click it to enter the speed menu.

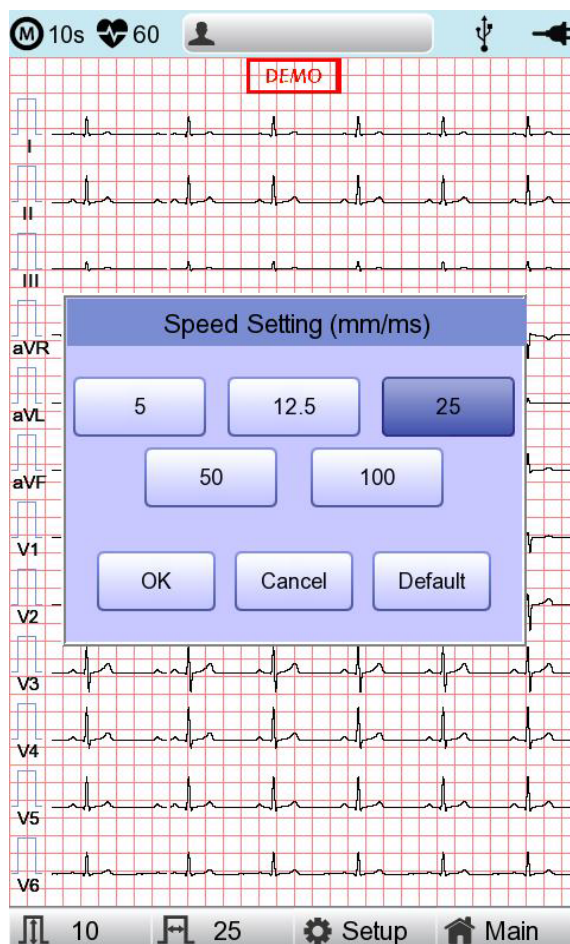

- Menu Navigation  
Operate by rotating the rotary key. Menu movement will occur in the same direction as the direction of the key's rotation.
- Menu Selection  
Initiate by pressing the rotary key. Menu box for setting of the selected menu will be displayed.
- Modifying setting values  
Move to desired setting, then modify & select values in the same manner as menu movement shown above. When you select either 5mm/sec, 12.5mm/sec, 25mm/sec, 50mm/sec or 50mm/sec at the 'Speed Setting' POP-UP, the POP-UP window will disappear.

### **Using the touch screen to modify the information**

When using the touch screen, only two procedures, menu selecting and information modification, are required.

- Select Menu  
Press the menu on the screen. Unlike the rotary key, the menu box you want to set up will show at the same time.
- Change the value  
Press the chosen item on the screen after moving to the page.

## Patient Information Input

In this menu, operators can input the patient's ID, name, age, sex, height, weight, race and smoking habit.

The screenshot shows a 'Patient Information' form with the following fields and values:

- ID: [Empty]
- Name: [Empty]
- Age: [Empty] years
- Gender: Female
- Height: [Empty] cm
- Weight: [Empty] kg
- Race: Asian
- Smoke: No
- Department: [Empty]
- Room No: [Empty]
- Study Desc.: [Empty]
- Accession No.: [Empty]
- Ref. Physician: [Empty]

Buttons at the bottom of the form are OK, Cancel, and New.

### NOTE

- The patient's surname is available after changing the file version to 1.1 in the BMS Server settings.

When the user selects the line of ID, NAME, Department, a keyboard will show up on the screen. The default of every line is a blank and if there is a certain figure on the line, it should be shown exactly when loading the keyboard window.

When the user wants to set the data after inputting, the user can press OK button on the keyboard and if the user wants to cancel the setting, pressing ESC button will do it and the keyboard window will disappear.

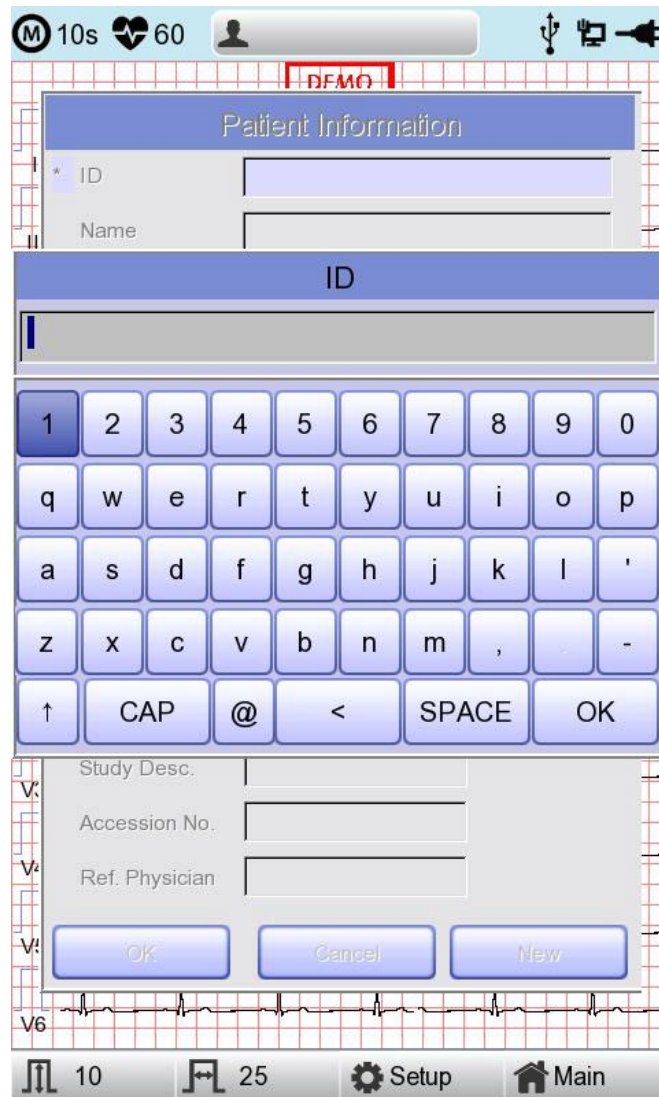

#### NOTE

- When entering an ID, it is impossible to enter special characters such as ", <, >, ?, /, \*, |, :, \, etc. (these invalid characters are set to be inactive)
- When entering an ID, an English keyboard will be displayed, regardless of whether there is a multi-language set-up.
- When entering an ID by connecting to an external keyboard, proceed by using general alphabet and numbers only. If you enter an ID using Latin extended characters and Russian, an error may occur when transferring files via PC and USB.

When the user selects the line of Age, Birth, Height or Weight, a keypad will show up on the screen. The default of every line is a blank and if there is a certain figure on the line, it should be shown exactly when loading the keypad window.

Enter an age and select the year of birth for >1 year old; enter age in the form of week or day for 1 < year old. Automatic diagnosis is available from postnatal day 1 for pediatrics.

When the user wants to set the data after inputting, the user can press OK button on the keypad and if the user wants to cancel the setting, pressing ESC button will do it and the keypad window will disappear.

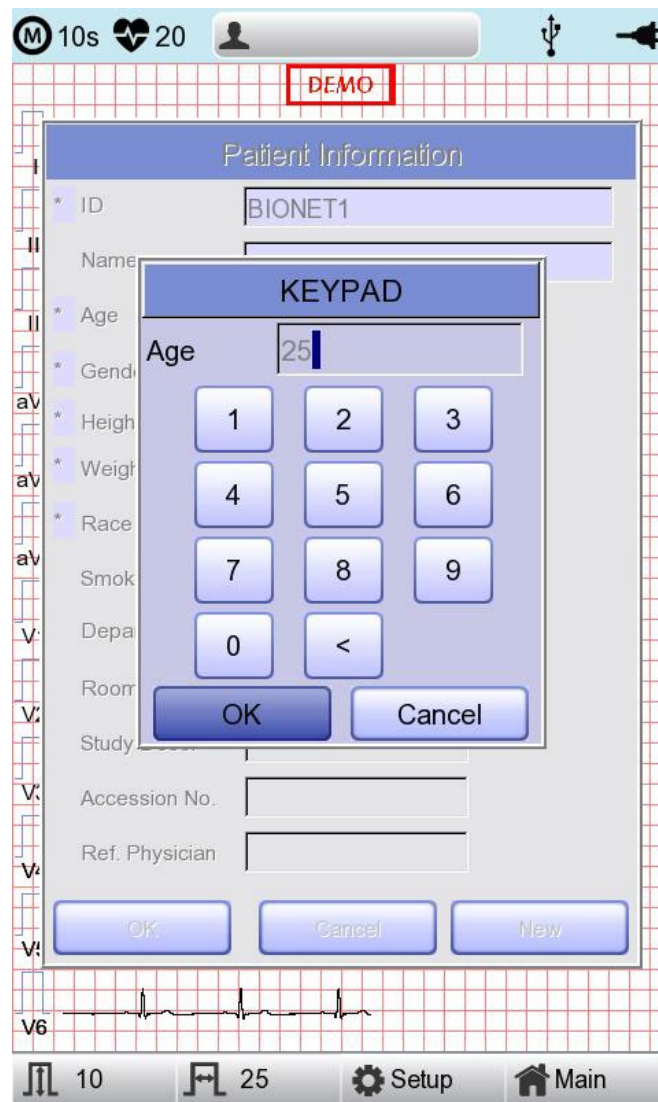

#### NOTE

- Pediatric diagnosis of the ECG is available from the first day of birth.
- If age is not entered, it will be diagnosed as an adult.

When clicking the Gender Line, the letter Male or Female will be shown respectively. After selecting the data which you want, input all the information of the patient. When pressing OK button, the information will be saved, while pressing cancel button will cancel the setting. The default of the Gender line will be set as a Female.

**Patient Information**

* ID	BIONET1
Name	Jane
F. Name	Smith
* Age	25 years
* Gender	Female
* Height	Female cm
Weight	Male kg
* Race	Asian
Smoke	No
Department	
Room No	
Study Desc.	
Accession No.	
Ref. Physician	

OK Cancel New

10 25 Setup Main

When clicking the Race Line, the choices of White, Asian, Black will show up. After selecting the data which you want to, input all the information of the patient. When pressing OK button, the information will be saved, while pressing cancel button will cancel the setting. The default of the Race line will be set as Asian.

**Patient Information**

* ID	BIONET1
Name	Jane
F. Name	Smith
* Age	25 years
* Gender	Female
* Height	173 cm
Weight	55 kg
* Race	Asian
Smoke	White
Department	Black
Room No	
Study Desc.	
Accession No.	
Ref. Physician	

OK Cancel New

10 25 Setup Main

You can decide whether or not to smoke by clicking Smoke. The default setting for Smoke is "No."

When you have completed inputting all information, you will see the window as shown below. After checking all information then pressing OK button, the information will be saved, while pressing cancel button will cancel the setting.

When pressing the 'New' button, all of the information will be initialized.

#### Note



Patient information will be initialized if the language preference is changed in the system setup.

### Entering patients information using a barcode reader

Patients' ID can be registered using a barcode scanner. Patients' ID will be entered automatically when the user scans the barcode on Spiro main screen.

Normally barcode scanners are compatible with all products. However, because of inconsistencies in barcode scanner manufacturers implementation of input methods, you need to verify the scanner whether it is supported by Bionet.

- Input methods supported by Bionet: International standards, USB
- Products below are tested and confirmed by Bionet for Cardio7e/Cardio7.

No	Manufacturer	Product name	Product image
1	Symbol	LS-2208	
2	ZEBEX	Z-3110	
3	Honeywell	MS5145	

#### Caution

It is must be read the user manual of the barcode scanner to get complete information about it.

The initialization codes for various products would be included. You must run the initialization after verifying the input type.

## Sensitivity Setup

This is a functionality that can modify sensitivity of the output signal, when the outputting signal's amplitude is too large and causes overlap with neighboring signals, or too small so that signal diagnosis is difficult.

Users can set all 12 channels to 2.5mm/mV, 5mm/mV, 10mm/mV or 20mm/mV. Users can also set it to Auto which will automatically set the sensitivity level for each channel; for example limb electrodes(I, II, III, aVR, aVL, aVF) to 10 mm/mV and chest electrodes(V1, V2, V3, V4, V5, V6) to 5mm/mV. Note that 10mm/mV means printing 1mV signal as 10mm in amplitude on the printing paper.

The left side of the graph display will show the channel name and a bar graph, so users can notice recently changed values easily. However, for 20mm/mV, the size of signal is set to be shown for 6 signals only to avoid overlapping signal size displays.

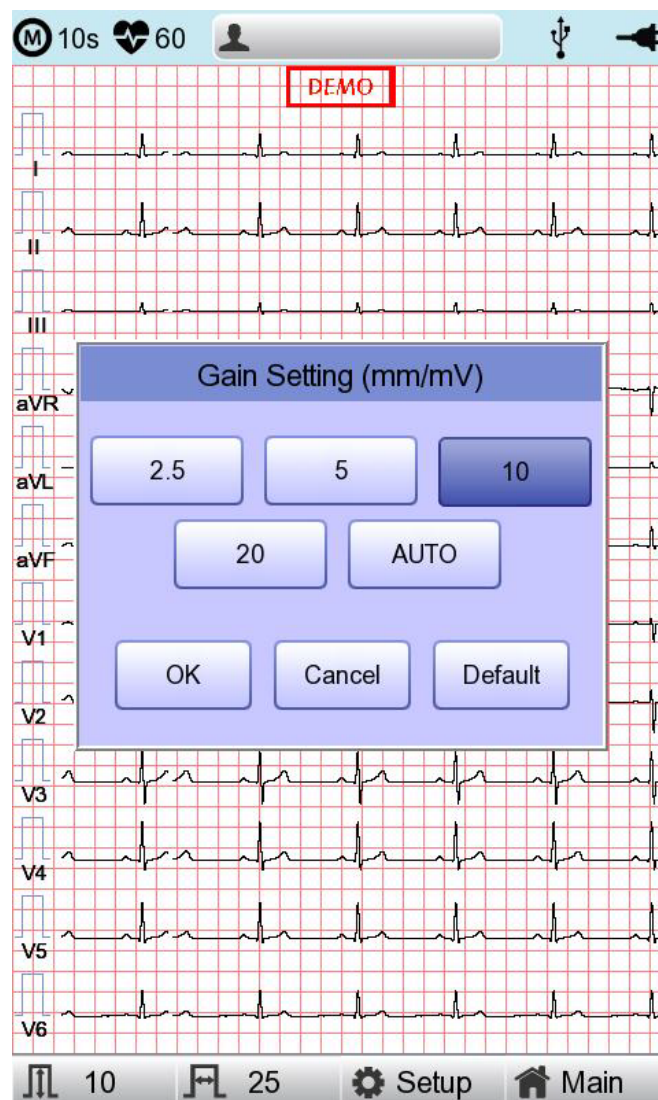

### NOTE

If Long Time function is set as 3min, 5min and 10min, output will result in 5.0mm/mV.

## Printing speed Setup

This is a function to adjust the width of the printing signal. The values are available in 12.5mm/sec, 25mm/sec and 50mm/sec. If you set 25mm/sec up, the ECG signal will be recorded in 25mm for one second. Therefore, the 12.5 mm/sec width is equal to half of the 25 mm/sec width; the 5 mm/sec width is equal to 1/5 of the 25 mm/sec width.

The 50mm/sec width is equal to twice that of the 25mm/sec width; the 100mm/sec width is equal to twice that of the 50mm/sec width. Therefore, if you want to have a wide signal, set up the bigger value.

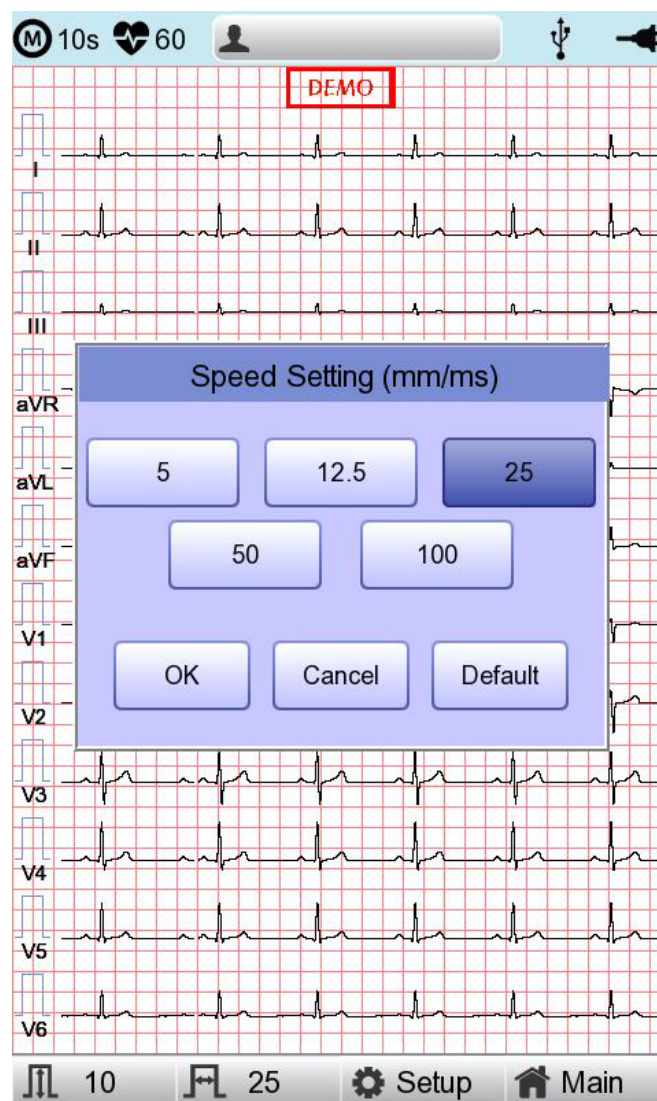

### Note

- When monitoring is set to 'Mon Size' -> 'A4', the printing speed is 25mm/s.
- if Recording is set as Long time 3 min, 5 min and 10 min, the resulting output will be in 12.5 mm/sec.

## 5) LCD Monitor display

Monitor mode display shows the currently measured electrocardiogram signal in real time. The monitor mode display function is used for the following two purposes: One is to check whether the signals from all channels are coming out properly; the other one is to see the status of the electrocardiogram of the patient for an extended time.

The printing speed can be selected to 5mm/s, 12.5 mm/s, 25 mm/s, 50mm/s and 100 mm/s, and the sensitivity can be selected to 2.5 mm/mV, 5 mm/mV, 10 mm/mV, 20 mm/mV, and Auto.

Displayed heart rate is the average of 4 heartbeats

NOTE
The heart rate is between 30 ~ 300 bpm, and the error range is $\pm 3$ bpm.

## 6) Disclosure

The screen can be shifted to the 'Disclosure' function by pressing and holding the LCD at ECG main screen state for 3 seconds. 'Disclosure' function means data is buffered in the Disclosure Buffer, and then is shown when running the Disclosure menu; 5-minute data which is already saved is fully displayed at 1CH (refer to setting Print -> Rhythm ), and as the square field for the 10-second section where the user can select it to perform diagnosis output and data transfer.

The 10-second square field on the 'Disclosure Window' can be moved in 1-second increments by using rotary right/left keys; front and back 5-second section of touch pointer will be set by touching.

On this 'Disclosure Window', designated 10-second ECG data will be shown as 12-channel 10-second ECG data. If you press the 'All' button again, the screen will be converted to a 5-minute full ECG screen; if you press the 'Close' bottom, the initial ECG screen will return.

From the 'Disclosure Window', it is possible to output and transfer diagnosis by using 'Record,' 'Auto' and 'Net' key.

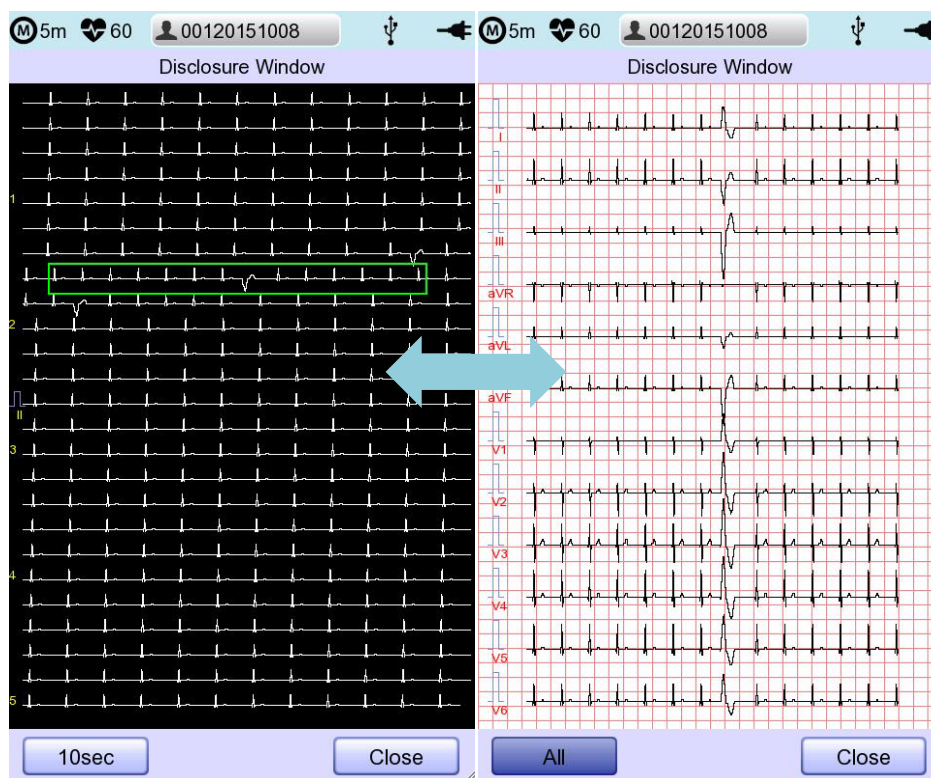

## 7) Rhythm Mode Printing

In rhythm mode printing, the measured ECG signals would be printed in real-time. Rhythm mode printing allows operators to perform the following two functions: one is to verify that signals in all channels are active before recording ECGs, and the other is to print the ECGs rhythm status of the patient for a longer duration.

Printing speed can be set to 5mm/s, 12.5 mm/s, 25mm/s, 50mm/s, 100mm/s and signal level can be set to 2.5mm/mV, 5mm/mV, 10mm/mV, 20mm/mV, and Auto.

When pressing the 'RHYTHM' key on the control panel, you will see the message as shown below and printing will start in accordance with the speed you set up.

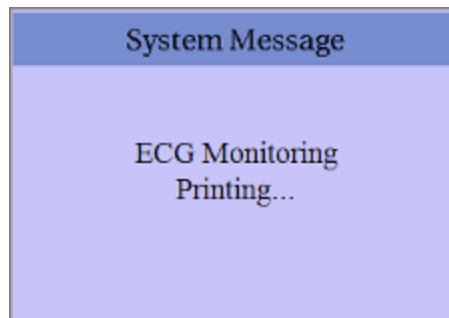

Press 'ESC' key to stop printing the ECG rhythm. After pressing the key, the system will stop printing and the display system setting after indicating the following message for 1 second on the LCD:

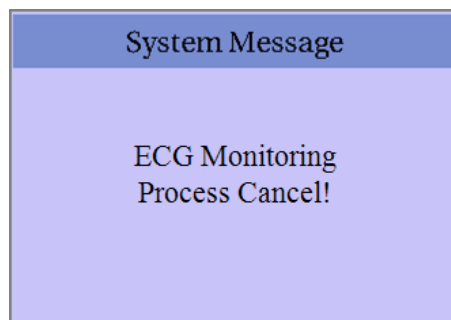

### Note

Even if ECG output speed is set as 100 mm/sec, it is not supported when outputting monitoring.

### Note

You should avoid connecting or disconnecting a USB device while printing out, as it could cause the printer module to rattle.

## 8) Record Mode Printing

For the record mode display, save the electrocardiogram in the memory first, and apply the filter which is set up by the user to the saved electrocardiogram, and then extract the parameters for the heart rate, PR interval, QRS duration, QT/QTc, and P-R-T axes. Then, print out the heart rate according to the sensitivity, printing speed, and channel form that are set up by the user.

### 10 seconds ECG recording

When one of 3ch+1rhy, 6ch+1rhy, 12ch, 3ch+3rhy and beat is selected for the channel form, press the 'RECORD' key to display the saving time as below and save the 10-second data.

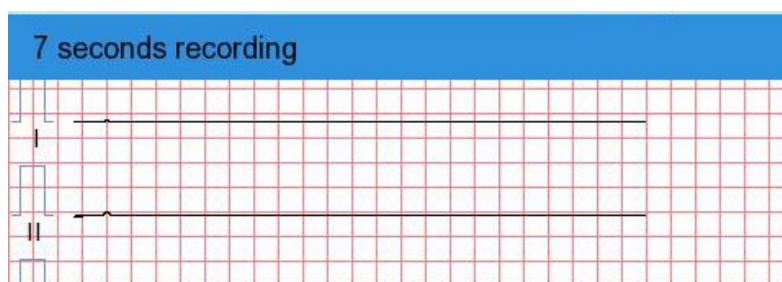

After saving the 10-second data and the parameters for diagnosis will be extracted, it will show the message as shown below and printing will begin.

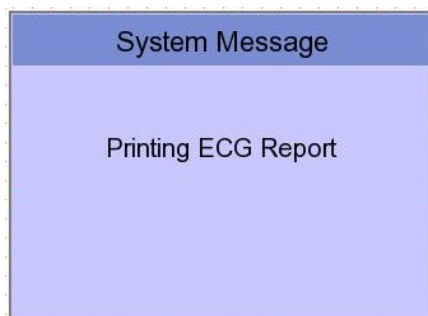

Enter 'ESC' key on the operation panel in order to stop while obtaining or printing out data. In this case, display the following message on the screen; cancel ECG recording if saving, otherwise end output while printing out.

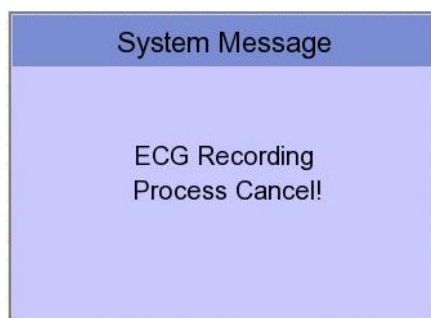

## 9) Printing Form

In this section, descriptions and samples of various printing forms are provided.

### ■ Rhythm Printing Form

- 3CH printing: To print 3 channels at the same time (I ~ III / aVR ~ aVF / V1 ~ V3 / V4 ~ V6)
- 6CH printing: To print 6 channels at the same time (I ~ aVF / V1 ~ V6)
- 12CH printing: To print 12 channels at the same time (I ~ V6)

### ■ Record Printing Form

- '3CH+1': I, II and III will be recorded for the first 2.5 seconds, aVR, aVL and aVF for the next 2.5 seconds, V1, V2, V3 for the next 2.5 seconds and V4, V5, V6 for the next 2.5 seconds. And 1 channel of rhythm will be recorded for 10 seconds at the bottom.
- '6CH+1': I, II, III, aVR, aVL and aVF will be recorded for the first 5 seconds and V1, V2, V3, V4, V5 and V6 for the next 5 seconds. And 1 channel of rhythm will be recorded for 10 seconds at the bottom.
- '12CH': 12-channel rhythm will be recorded as I, II, III, aVR, aVL, aVF, V1, V2, V3, V4, V5 and V6 at the same time for 10 seconds.
- '3CH+3': I, II and III will be recorded for the first 2.5 seconds, aVR, aVL and aVF for the next 2.5 seconds, V1, V2, V3 for the next 2.5 seconds and V4, V5, V6 for the next 2.5 seconds. And 3 channels of rhythm will be recorded for 10 seconds at the bottom.
- 6CH+1(ST): I, II, III, aVR, aVL and aVF will be recorded for the first 4 seconds and V1, V2, V3, V4, V5 and V6 for the next 4 seconds. And 1 channel of rhythm will be recorded for 10 seconds at the bottom. The amplitude of the measured ST wave is printed as an ST map. It is printed at 25mm/sec regardless of output speed

### ■ Form of Beat Report Output

- Choose an additional output form after printing out diagnosis: either Text, Guide or Vector.
- Text: to output representative beat and each diagnostic parameter. Output will come at 50mm/sec if the output speed is set at '5, 12.5 and 25 mm/sec', whereas it will come at 100 m/sec if set at '50 and 100mm/sec'.
- Guide: to output representative beat and each diagnostic parameter, with diagnostic guide for arrhythmia. Output will come at 50 mm/sec regardless of the output speed.
- Vector: to output representative beat and each diagnostic parameter and Vector of QRS, as indicated by the arrow. Output will come at 50 mm/sec regardless of the output speed.
- -ST Map (Dot): Prints the representative bit and each diagnostic parameter and displays the amplitude of the ST wave as a point and a linear ST Map. It is printed at 50mm/sec regardless of output speed.
- ST Map (Bar): Prints the representative bit and each diagnostic parameter and displays the amplitude of the ST wave as a bar ST Map. It is printed at 50mm/sec regardless of output speed

### Rhythm Report Form(3CH)

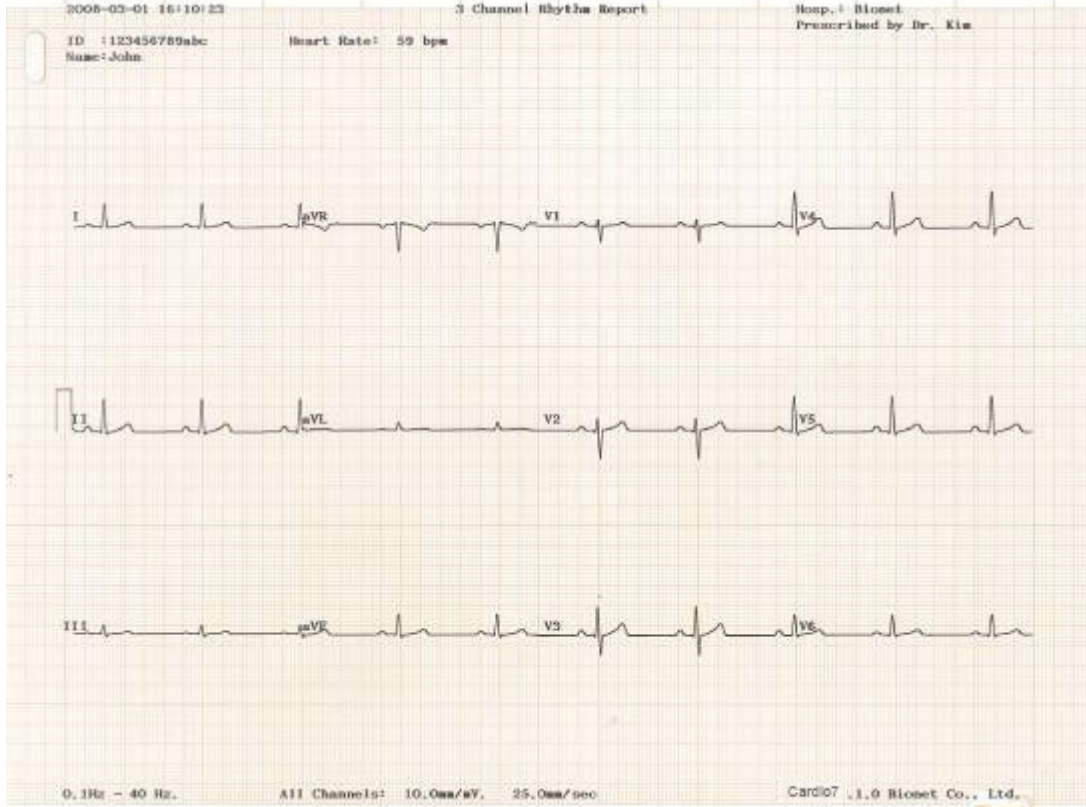

### Rhythm Report Form(6CH)

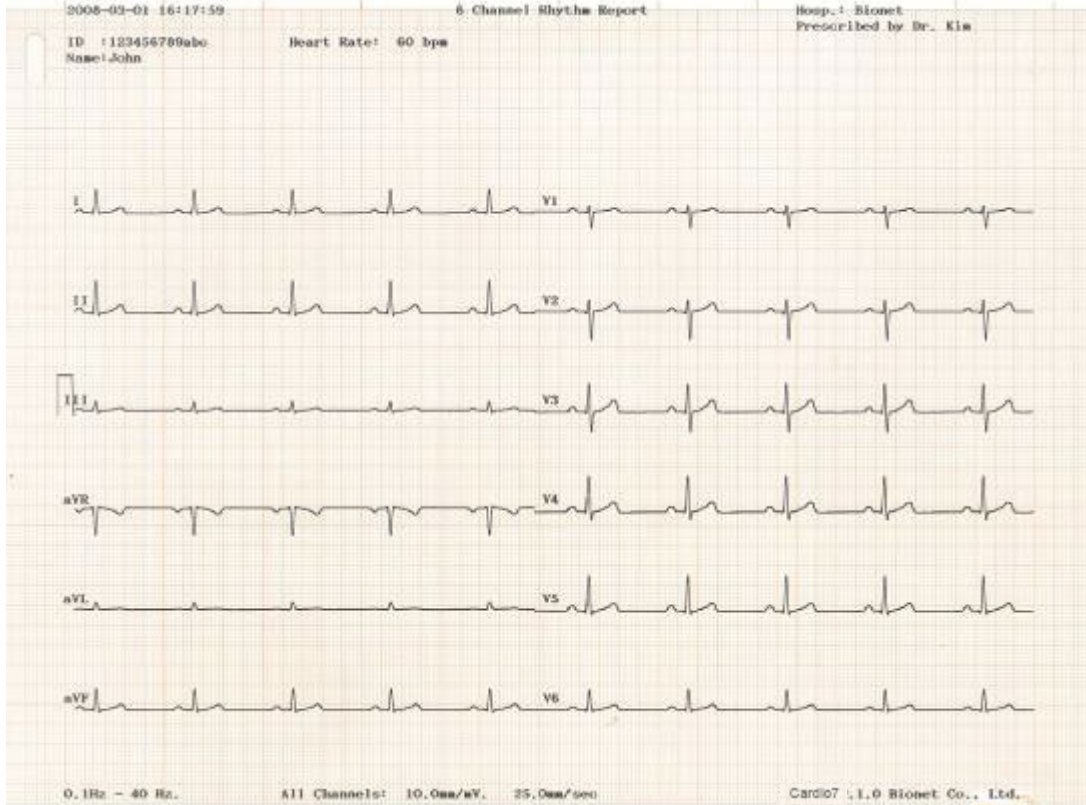

### Rhythm Report Form(12CH)



### Record Report Form (3CH + 1 RHY)

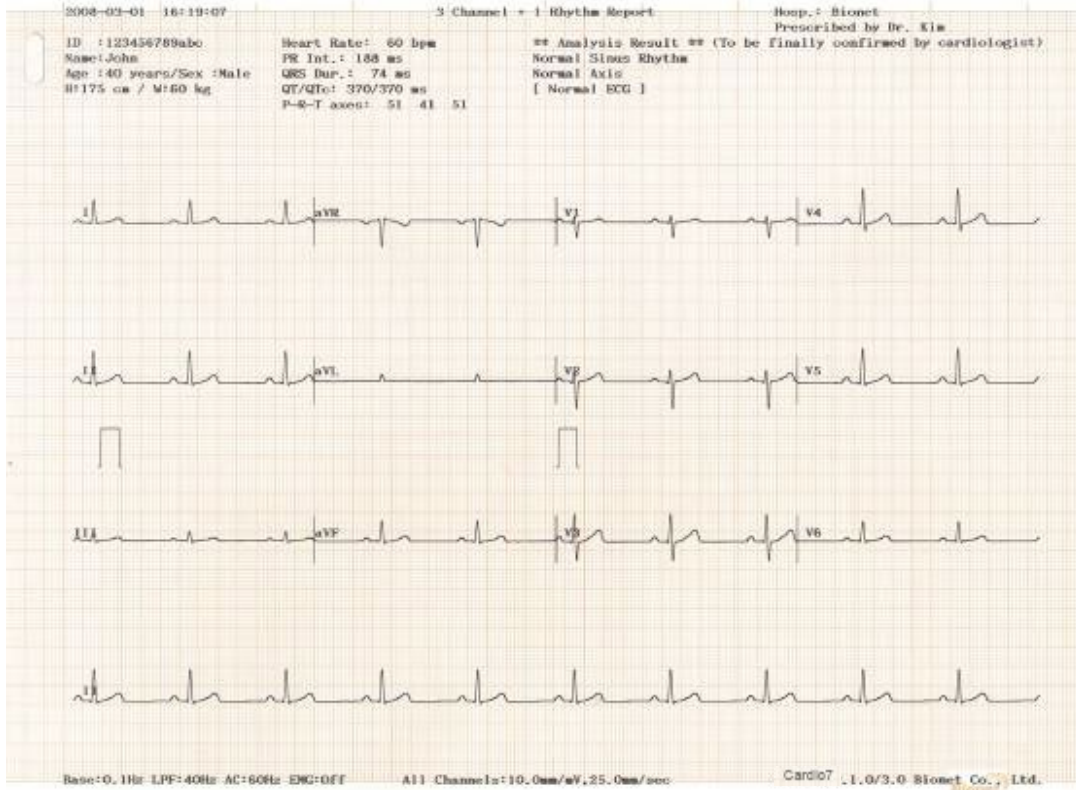

### Record Report Form (3 CH + 3 RHY)

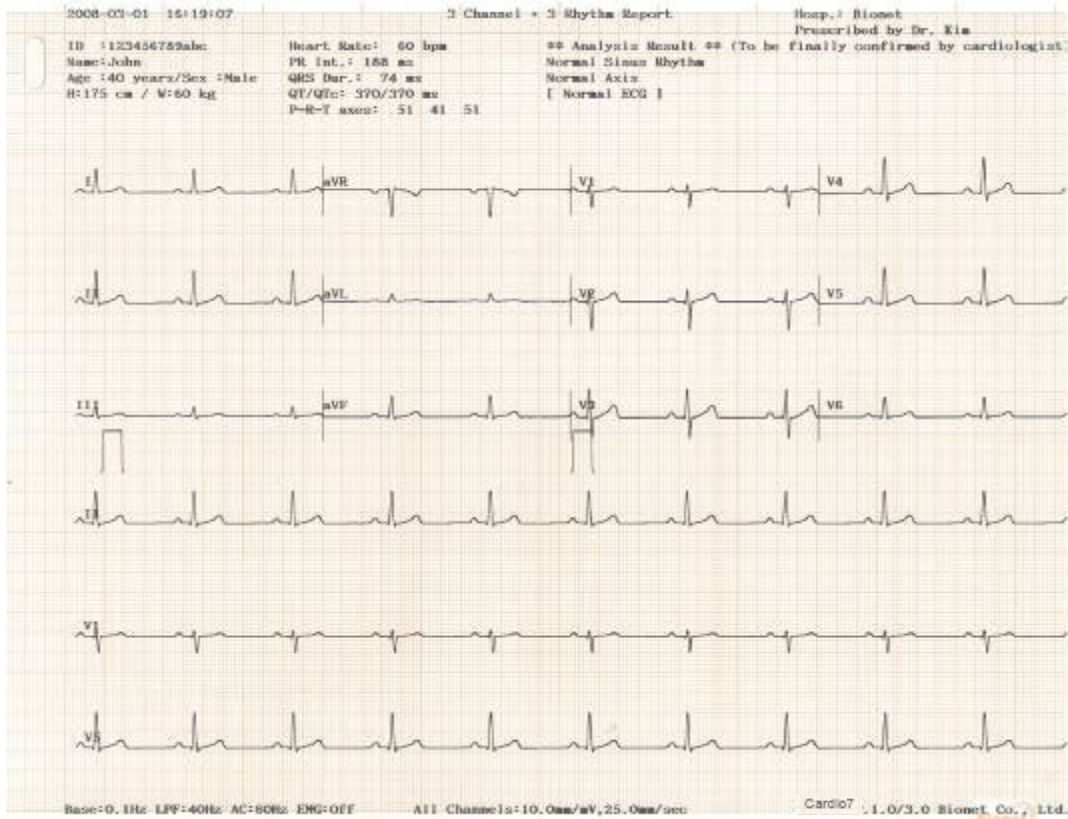

### Record Report Form (6 CH + 1 RHY)

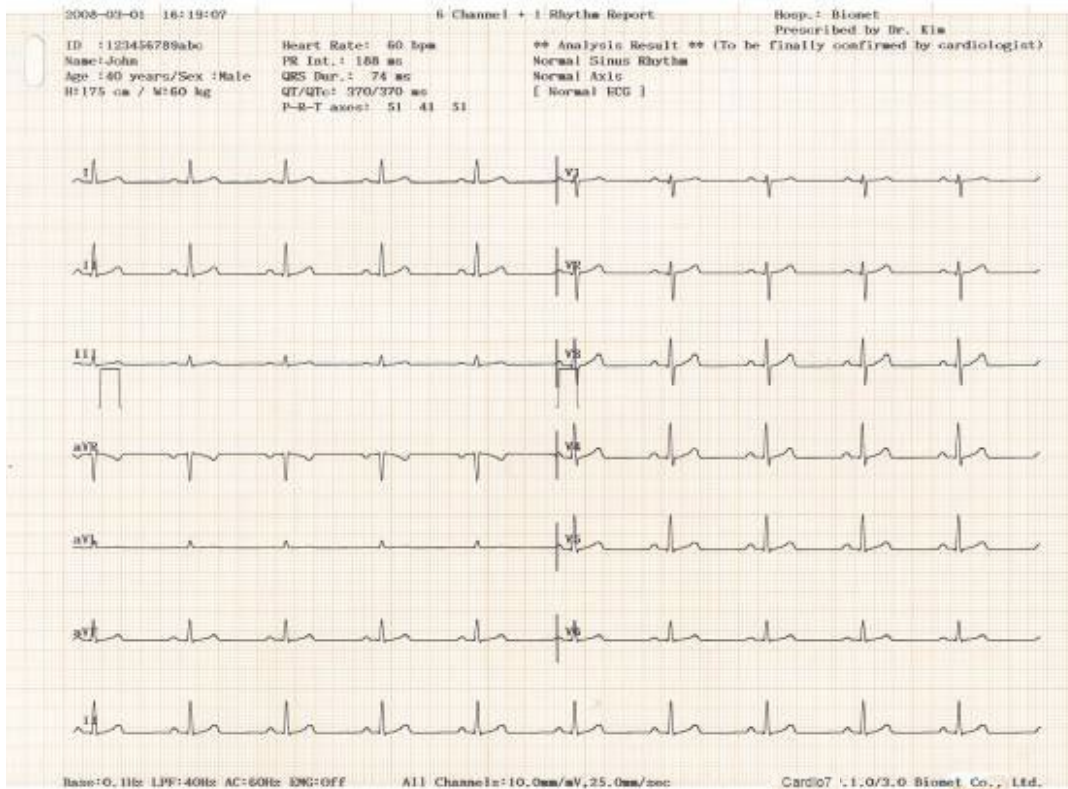

Record Report Form (12 CH)

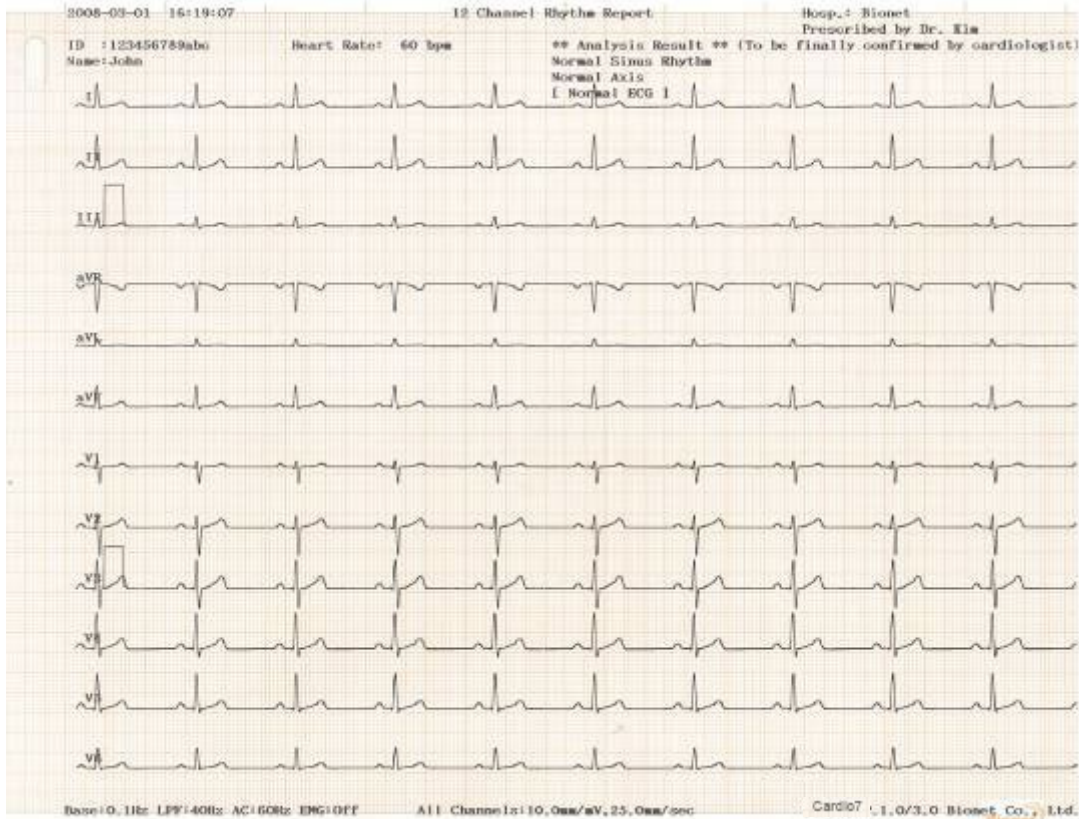

Record Report Form (6 CH + 1 RHY (ST Map))

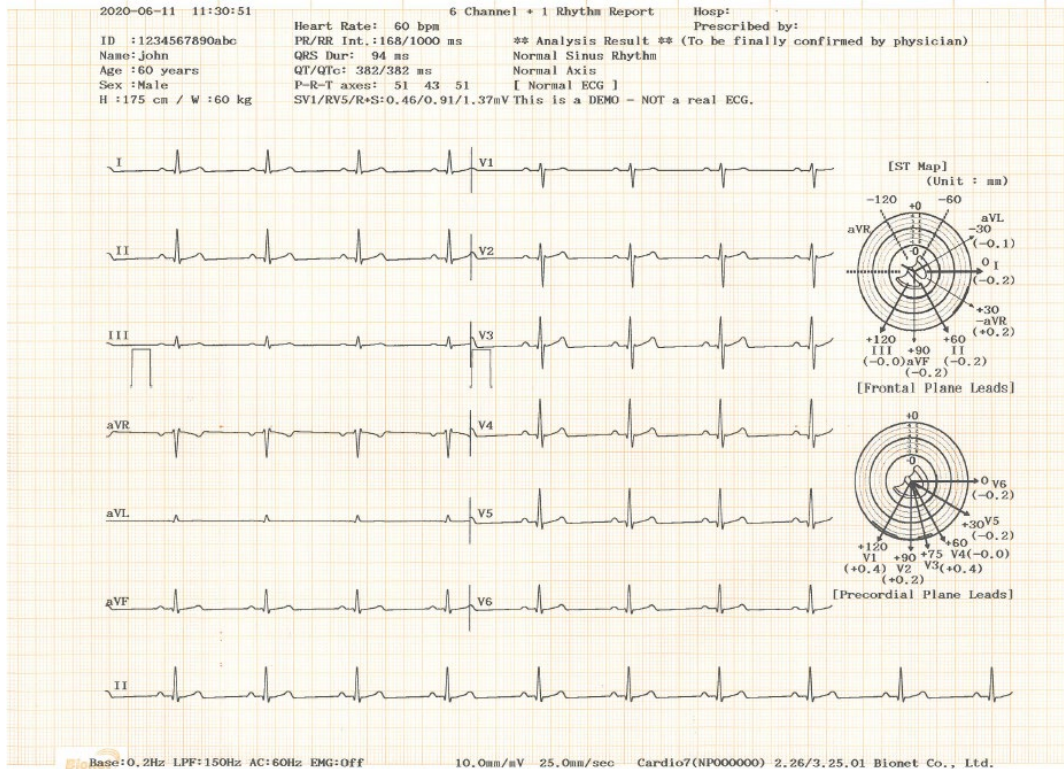

Record Report Form (BEAT REPORT - TEXT)

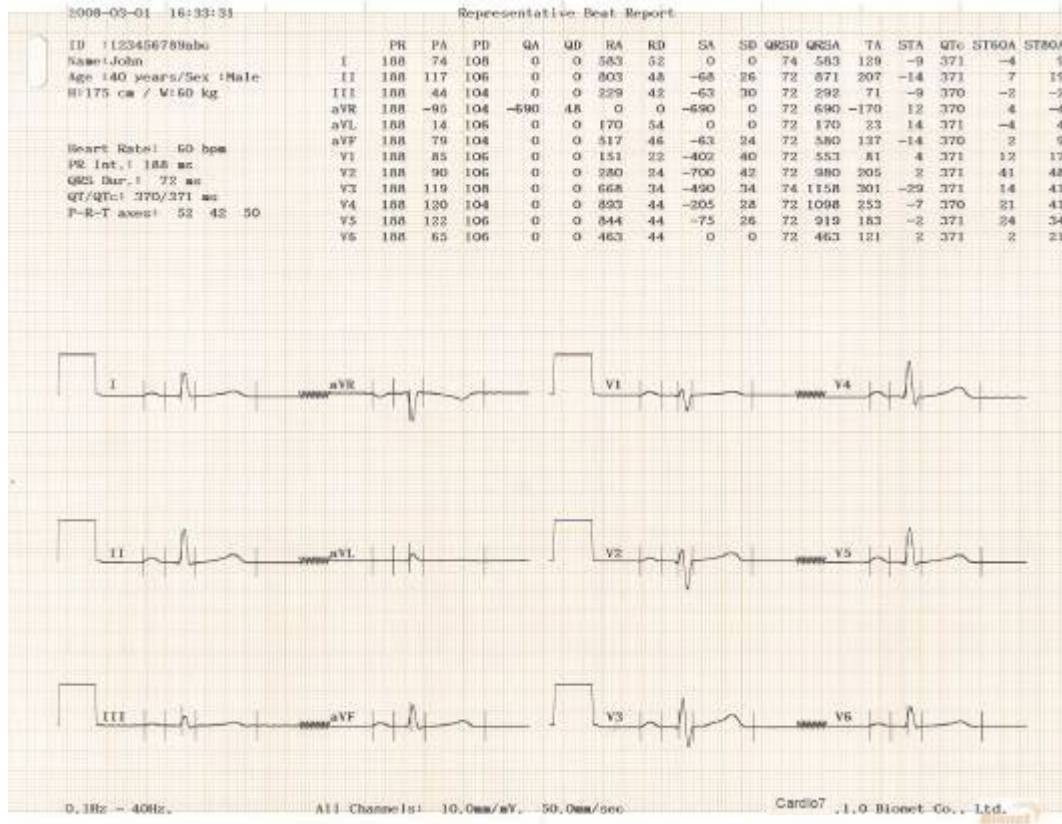

Record Report Form (BEAT REPORT - VECTOR)

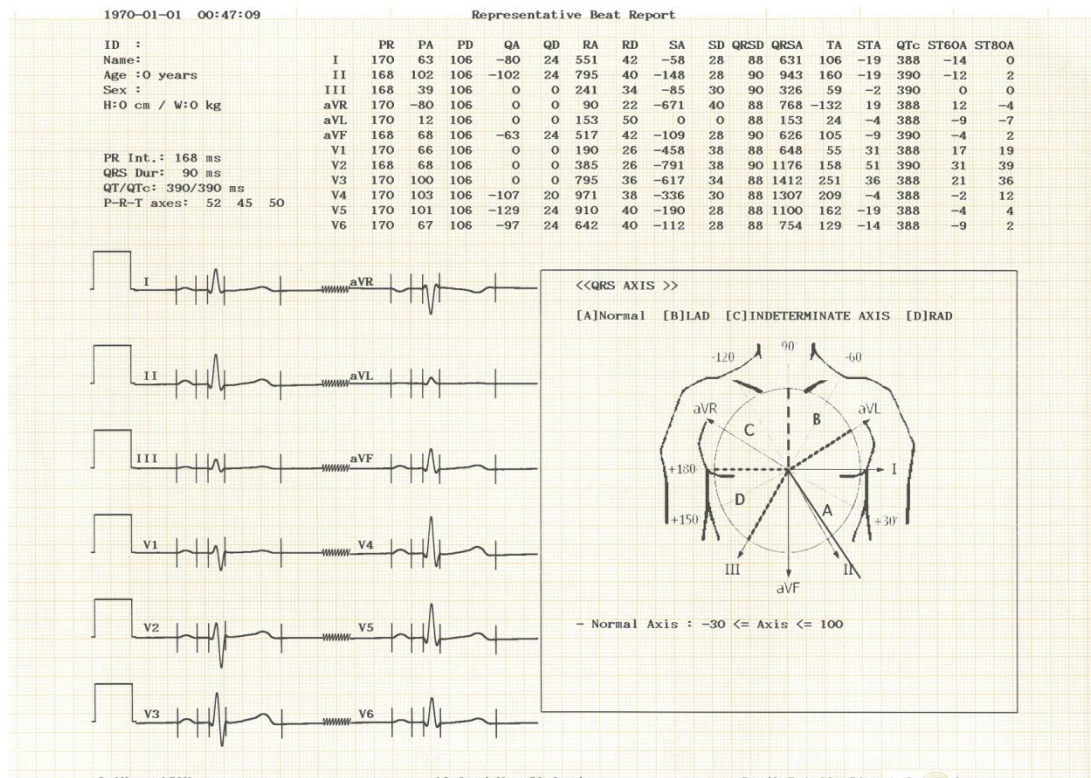

Record Report Form (BEAT REPORT - GUIDE)

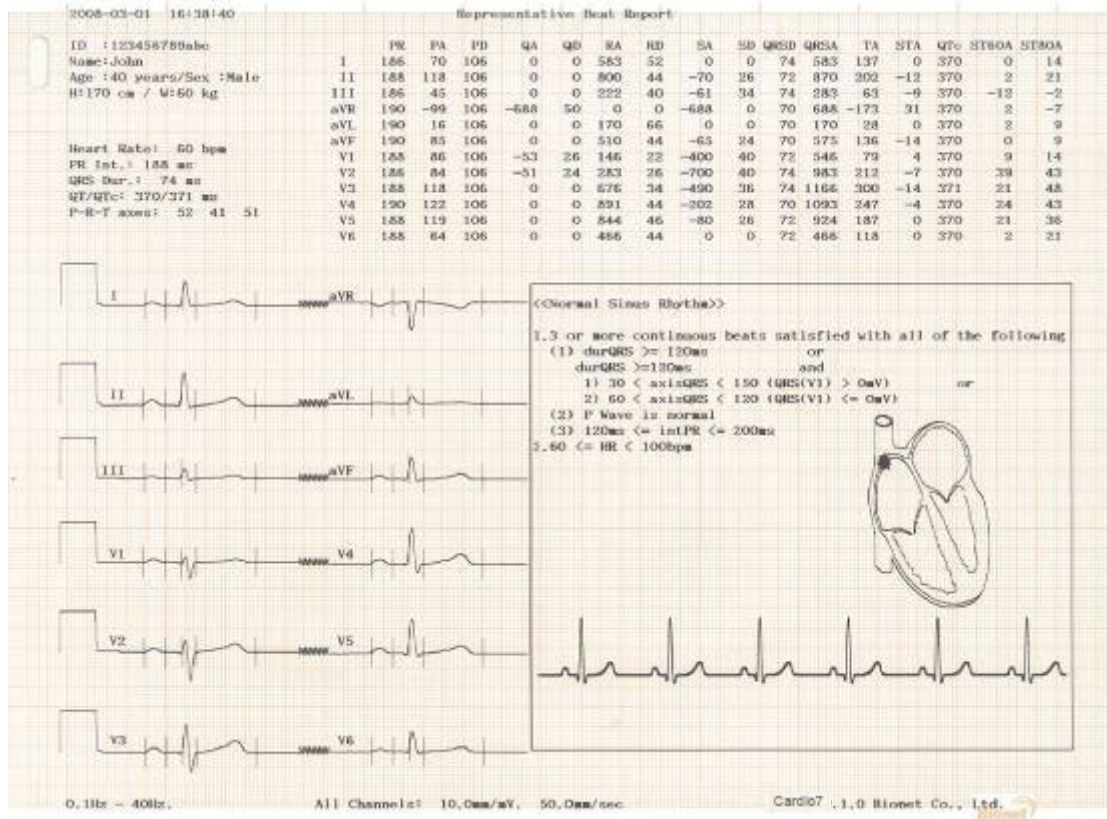

Record Report Form (BEAT REPORT - ST Map (Dot))

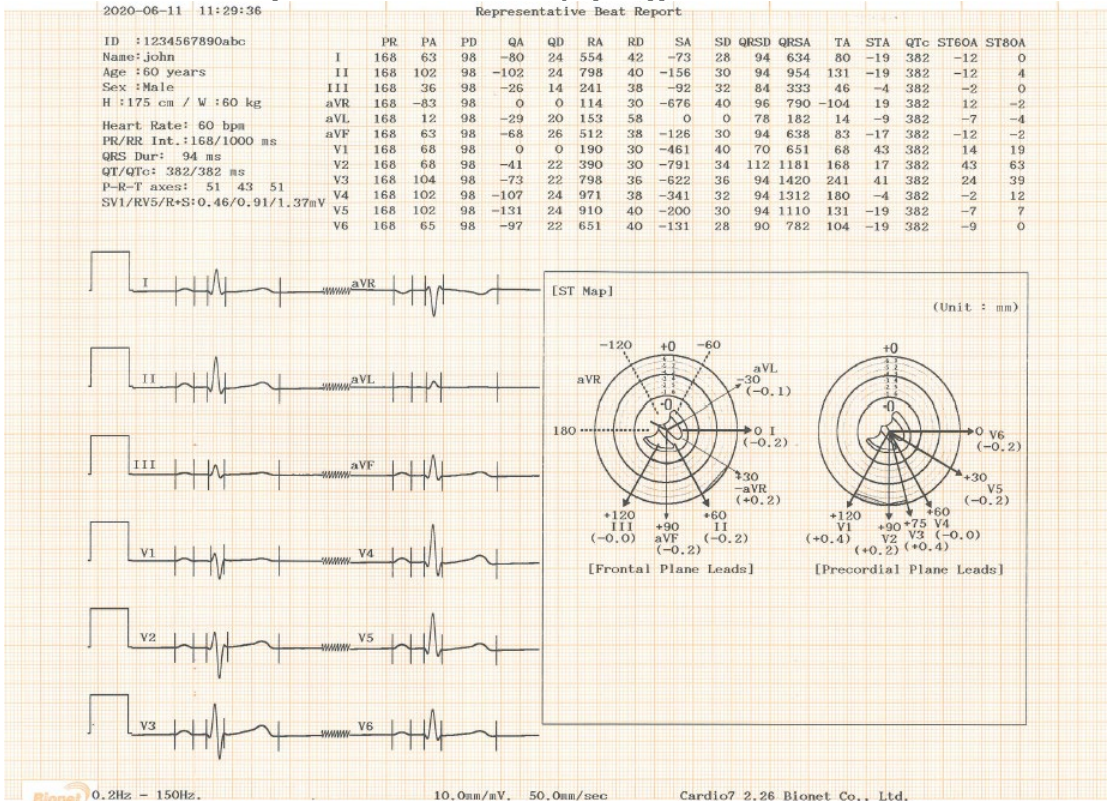

Record Report Form (BEAT REPORT -ST Map (Bar))

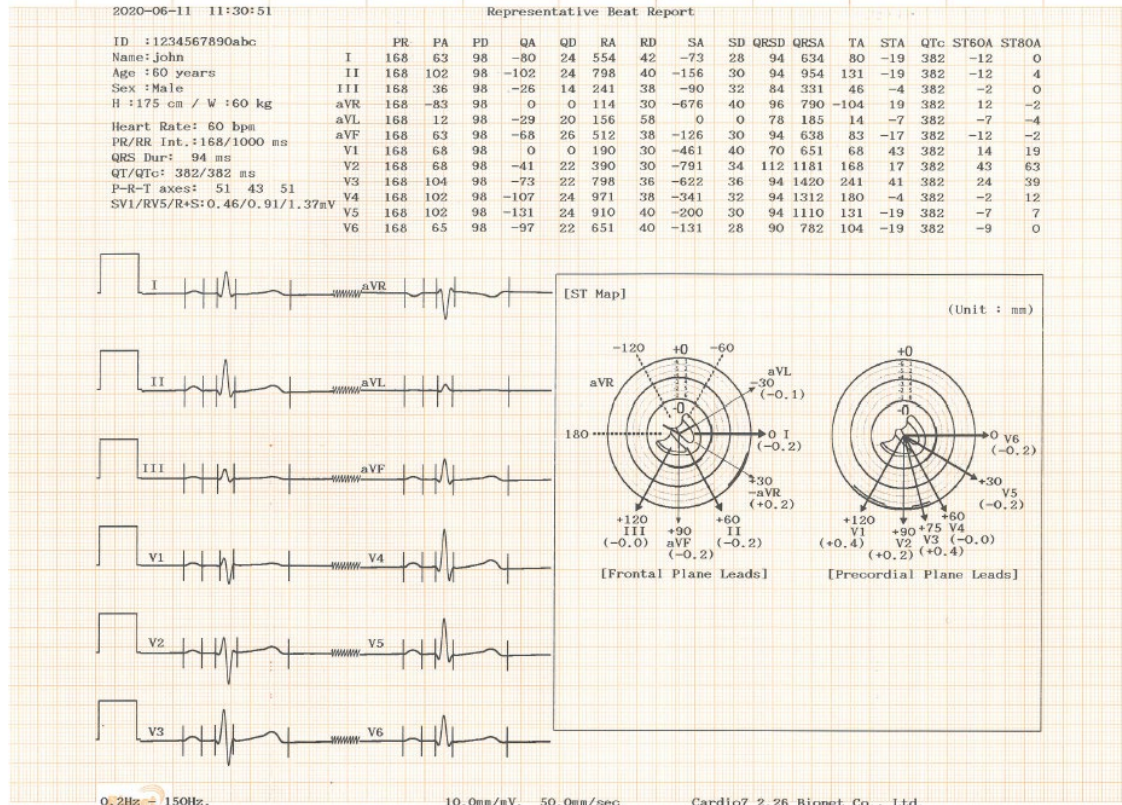

### Beat Report Parameters

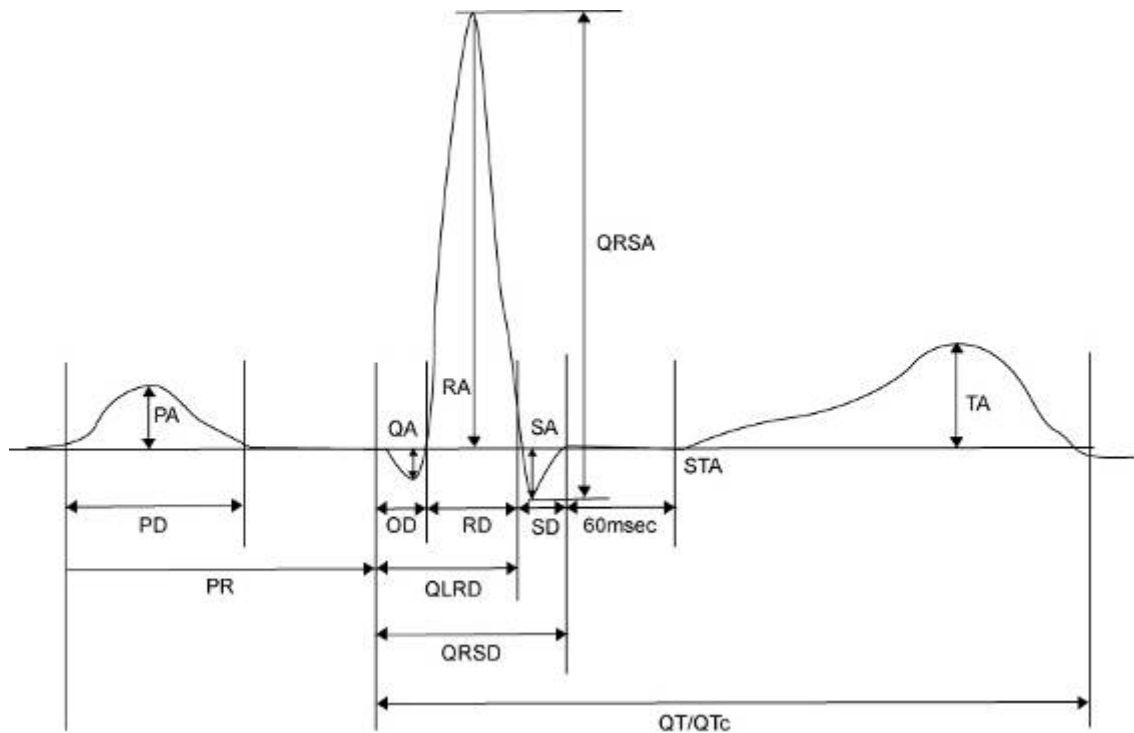

- PR: PR Interval
- PA: P Amplitude
- PD: P Duration
- QA: Q Amplitude
- QD: Q Duration
- RA: R Amplitude
- RD: R Duration
- SA: S Amplitude
- SD: S Duration
- QRSD: QRS Duration
- QRSA: QRS Amplitude
- TA: T Amplitude
- STA: ST Amplitude
- QTc: collect Q-T Interval
- ST60A: ST60ms Amplitude
- ST80A: ST80ms Amplitude

#### Note

The interval (duration, interval) of the parameters output to the Beat Report is in ms, and the unit of height (amplitude) is in  $\mu\text{V}$ .

**NOTE****Dextrocardia**

The human heart is normally located on the left side of the chest. However, in rare cases it is located on the right-side chest, which is a condition called Dextrocardia.

There is potential for dextrocardia if:

- P, QRS and T are all reversed on Lead I.
- aVR and aVL as well as lead II and III are switched with each other.
- As you proceed from V1 to V6, R wave is reducing on Chest lead.

For patients with dextrocardia, the result of a normal automated diagnosis can be obtained if measurement is conducted by switching electrodes over, as follows:

- Switch between Right hand (R) and Left hand (L) electrodes.
- Attach chest leads starting from the left side, rather than from the right.

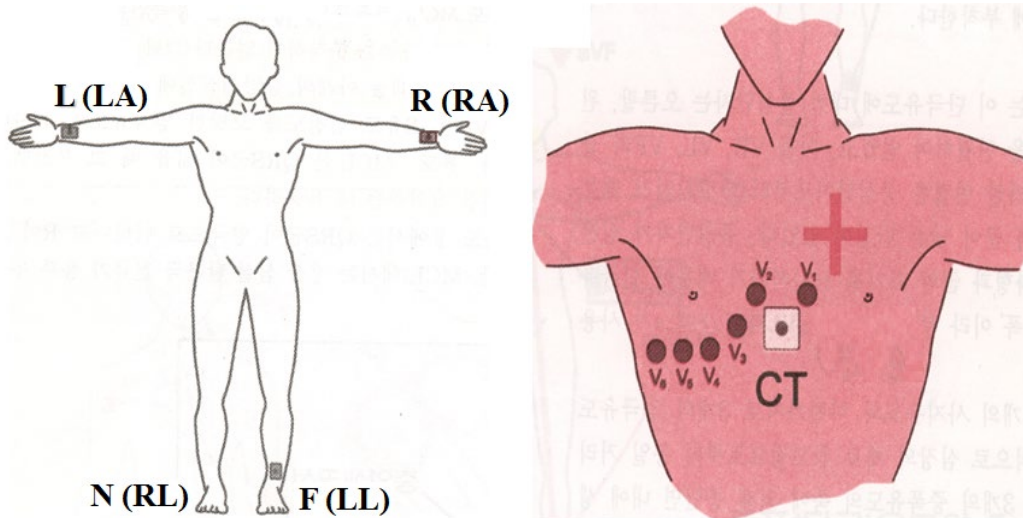

## 10) Copy Mode Printing

Copy Mode Printing is a function to print out the same report as the previously printed report. In Copy Mode, users can also print out the same previous data but with changed settings such as filter type, sensitivity, printing speed, channel form, and rhythm number if more than one rhythm is recorded.

Copy Mode can be entered by pressing the 'COPY' key following an EKG recording. After pressing the COPY Key, the following message will be displayed on the LCD screen, and the printing process will start:

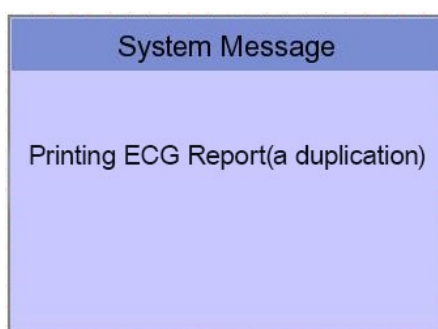

If Copy Mode Printing is called without performing an EKG recording, there would be no EKG data to copy. In this case, the following message box will be displayed:

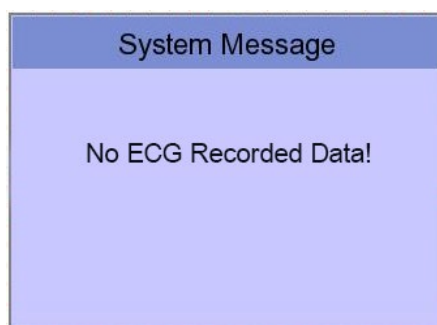

### Note

Copy function will become unavailable as data is considered as not existing if Long time function was set after 10-second recording or before 10-second recording. Copy function will become unavailable if the predetermined value of Long Time is changed.

If you change the filters on a previously saved ECG, it will adapt to the new filter. When the new filter is adapted completely, it will start printing after showing the message as below.

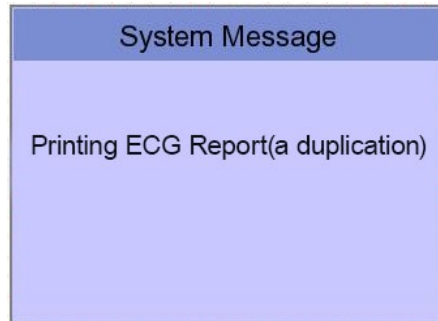

When printing is abnormally completed, the state of the system setting will be displayed after showing the message as shown below for a second.

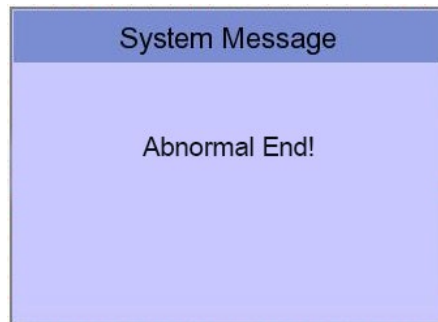

If you want to stop the process of printing, press the 'ESC' key. Then the process will stop, and you will see the ECG Main page after the message shown for a second as below.

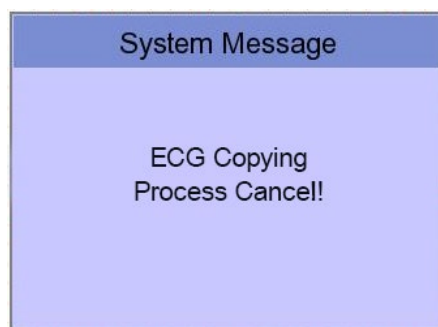

## 11) System Setup

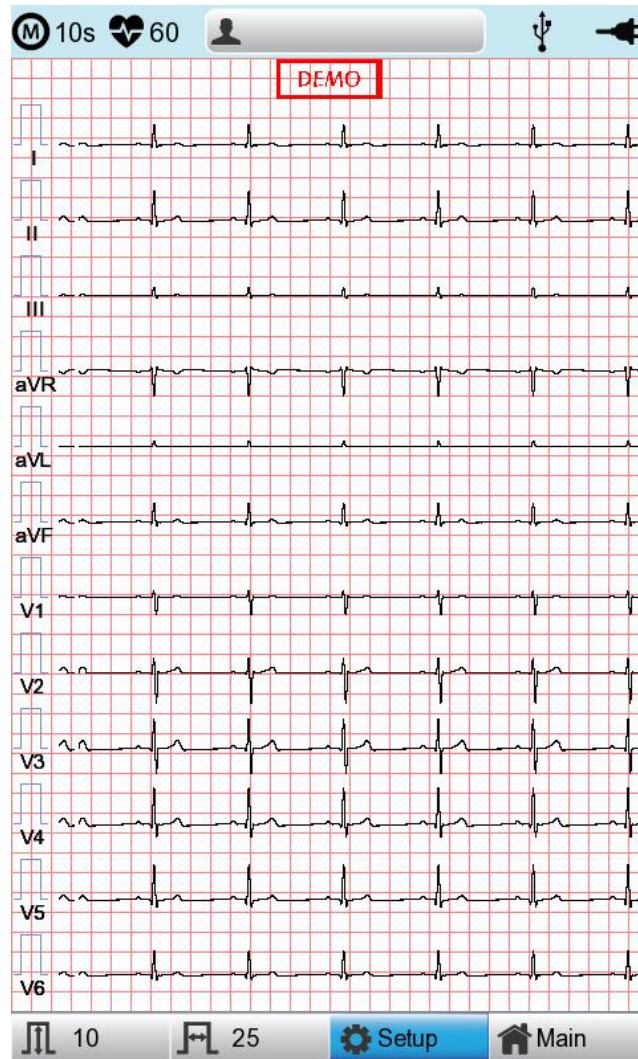

Choose the 'Setup' button on the initial ECG main screen to change preferences. Setup menu consists of Basic Setup, Network Setup, Hospital Setup, ECG Setup, Record Setup and Service Setup and you can change the setting at each window. The main page shows Basic Setup.

After finishing the settings, press 'OK' to save the new information or press 'Cancel' to cancel it. You can choose 'Exit' or 'ESC' button to exit from the setup menu.

'Default' button is used to default every setting.

## Basic Setup

When choosing Basic menu at the left side of the Setup page, you will see the page for Basic Setup.

Basic Setup consists of Date, Time, Touch screen, Start Option, Unit, Date Type and Device Name menus.

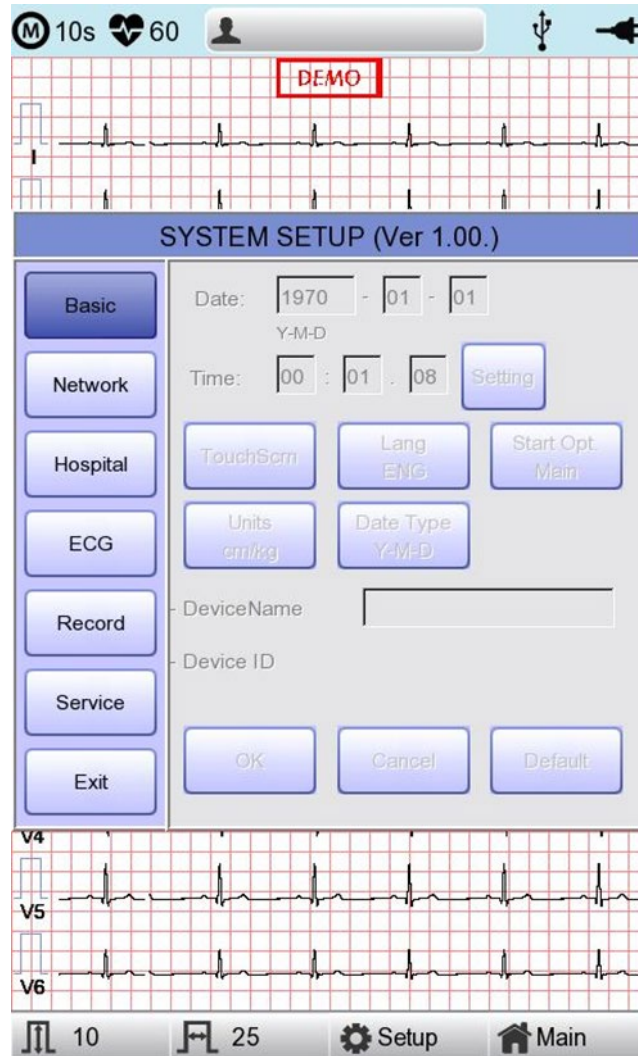

## Setup date and time

After choosing the Setup menu, press the Basic button then the focus will go to the 'Date' item.

By using the touch screen or rotating the rotary switch, choose the Date (yyyy/mm/dd) or Time (hr/min/sec), then the keypad will show up. You can set up the information by using this keypad.

The Focus will go 'year → month → day → hour → minute → second' consecutively.

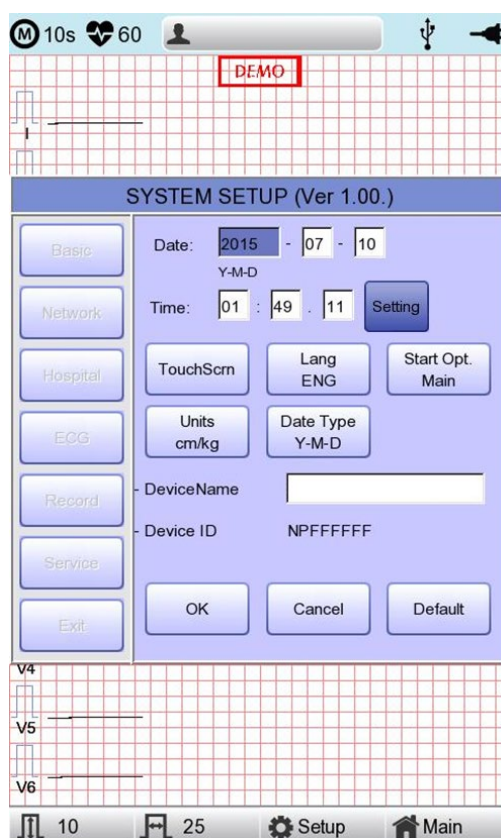

If you press the Setting button, you can use the NTP function to get the time from the network and the Time Zone function to set the time of the area where the equipment is installed.

### Note

- When the Time Zone setting is changed, the device is rebooted for stable operation.
- Depending on the network condition where the equipment is installed, it may take a long time for the NTP function to be activated for the first time.
- The NTP function does not work unless an exception is handled by the firewall.
- - When using the NTP function, the initial time must be set to the current time. If the difference between the set time and the current time is large, the initial setting may take a long time.

## Touch Setup

This is a menu to set up the coordinates of the touchpad. When selecting the 'Touch' menu at the Basic Setup page, setup page will disappear and the coordinates for setting calibration will appear as shown below. Follow the instructions shown on the screen, and then the coordinates will be set up.

Please input the information in the right place, otherwise the touchpad may not work properly.

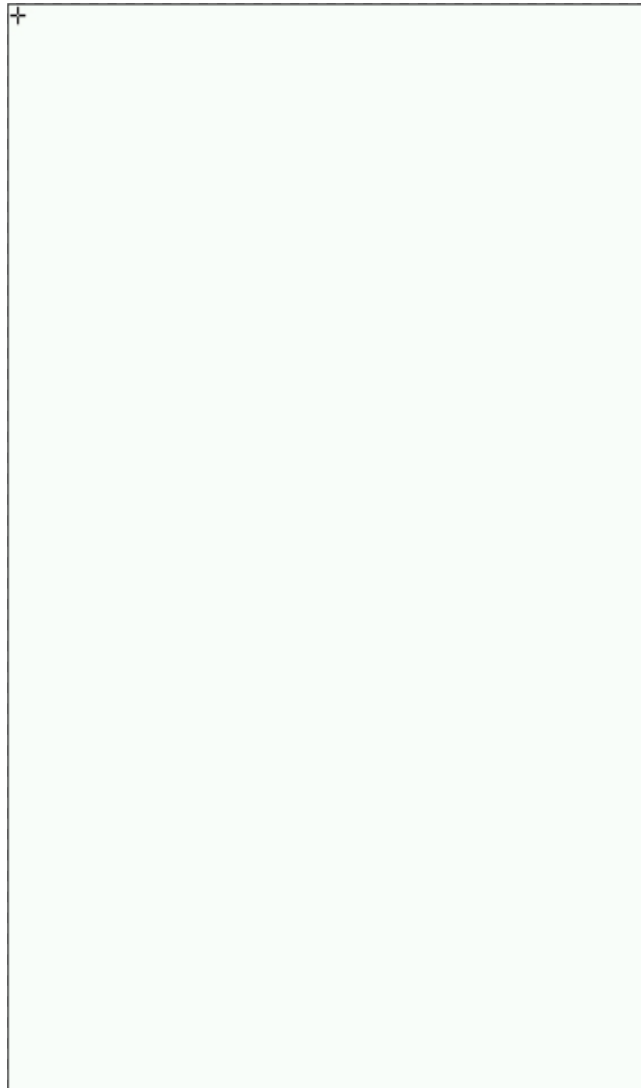

### Note

When the user selects the Touch Setup menu, all windows will disappear, and the touch screen setup will start. No keys will be operational until the Touch Setup is complete.

## Language

As shown below, when selecting 'Language' menu at the Basic Setup page, you can choose the language among

English, French, German, Italian, Korean, Polish, Portuguese, Rumanian, Russian, Spanish and Turkish.

Select the language you want to use and click the OK button and then you can use the service in the chosen language.

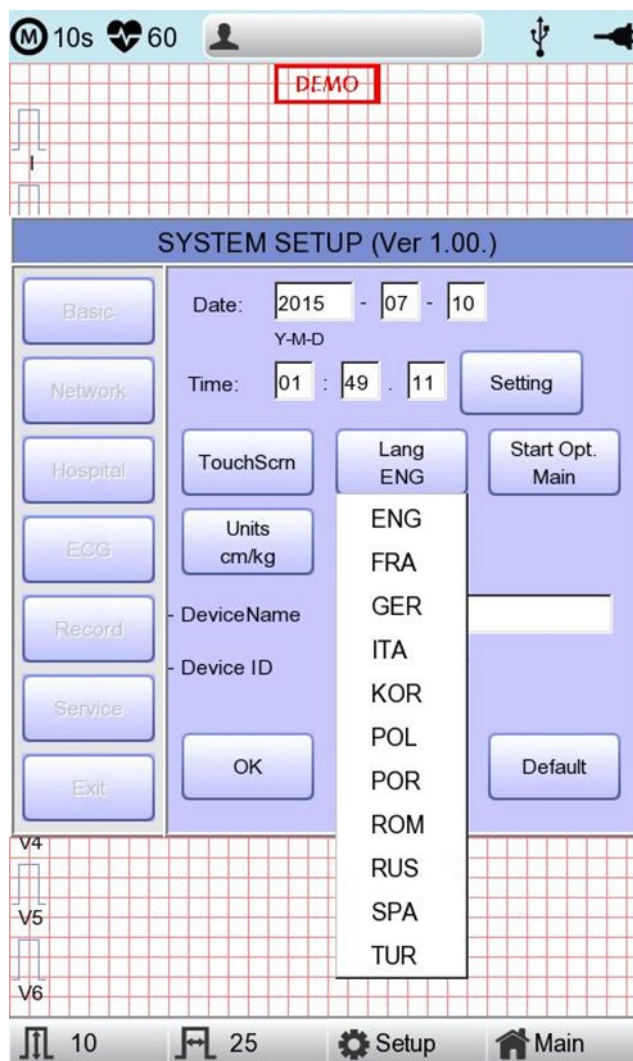

### Note

Patient information previously entered will be initialized if the language preference is changed.

### Note

If language preference is set as "KOR," only the menu on the LCD screen will be shown as Korean, whereas the output will be in English when printing out.

## Start Option

You can set up the index page shown at the time of initial boot up, according to the common dialog.

When clicking the 'Start Option' button, a small menu window will appear and you can select the initial page you want to have among MAIN, FILE, WORKLIST, ECG, SPIRO.

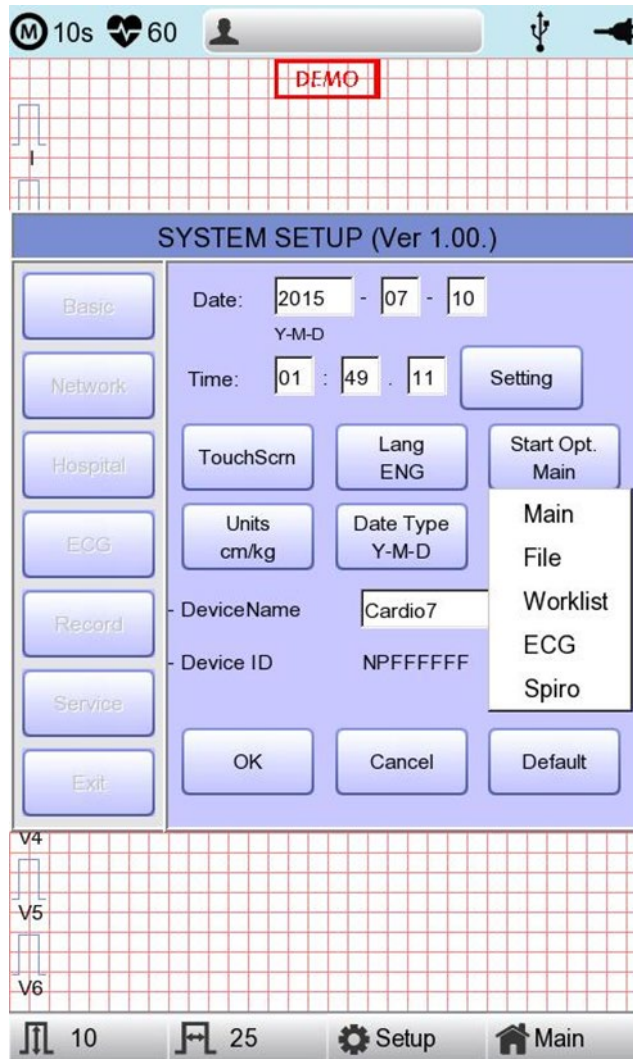

## Units

This menu is to select the units for height and weight of the patient. When you click Units' button, cm/kg or Inch/Lbs will be shown.

If you select Inch/Lbs unit, the patient's height information will be expressed in \*\*\* Ft Feet) \*\*\* Inch.

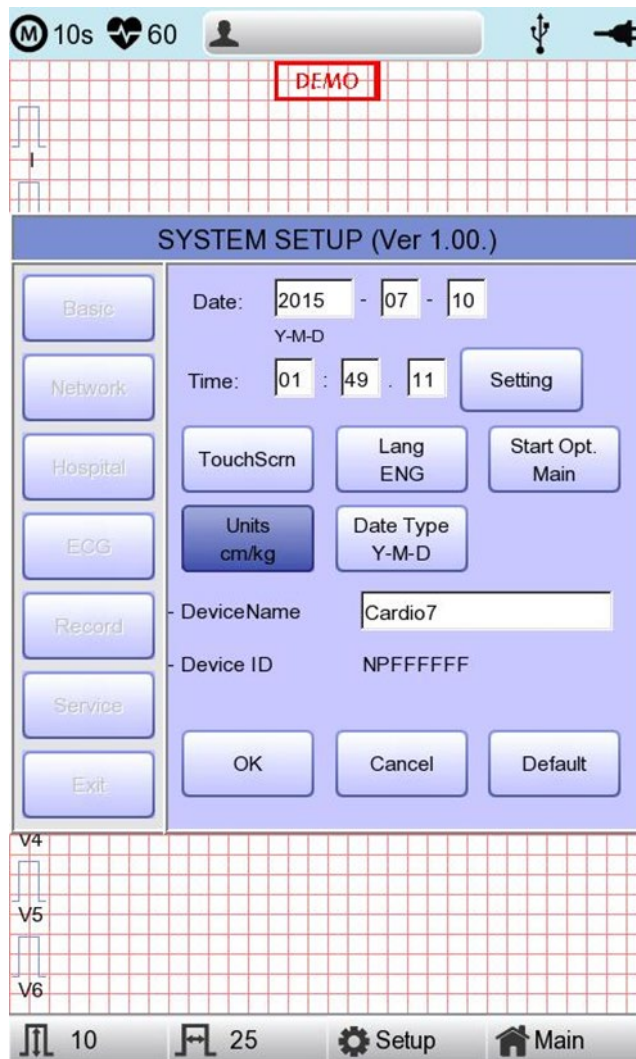

## Date Type

As seen in the figure below, the date format on the top of the paper can be changed while printing out monitoring and recording results if you choose 'Date Type' from the Basic Setup menu. Choose the date format to be used, and then click the 'OK' button; the date format is converted to the one selected and can be seen on the output.

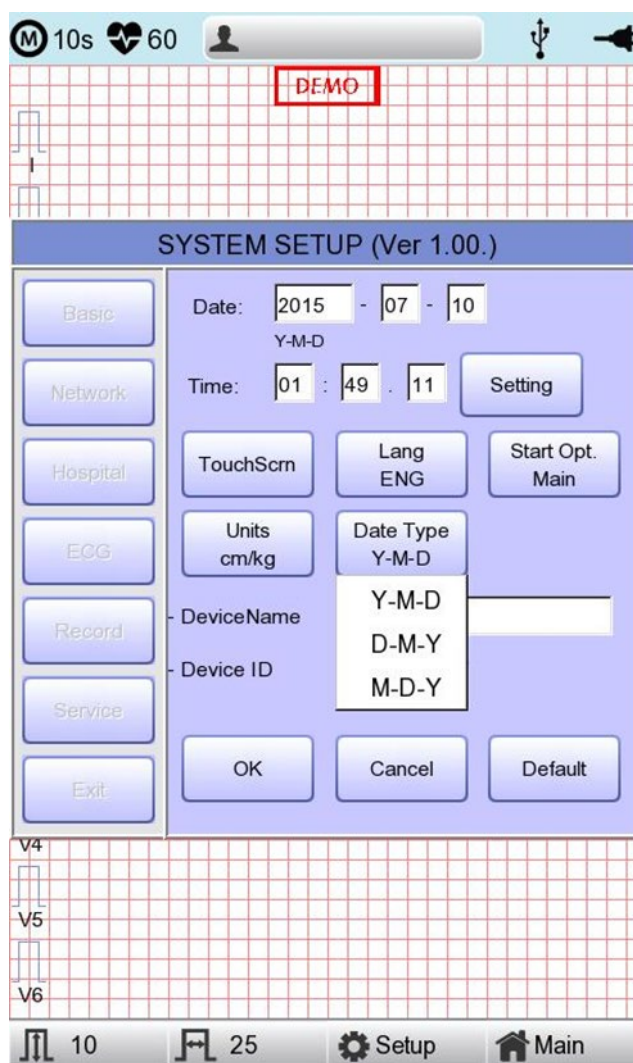

## Device Name Setup

'Device Name' refers to the name of the device. The user can input the name of the device in order to distinguish devices on PC easily.

'Device ID' cannot be revised by the user as it is a unique ID of the device and is used to identify devices on a PC. 'Device ID' is automatically set for easy identification of devices on the connected PC; therefore, it cannot be revised by user.

## Network Setup

When connecting the equipment with LAN to interface with the outside PC, network setup is needed. Network IP is required, and DNS is not used.

When selecting the Network menu at the left side of the System Setup page, Network Setup page will show up at the right side.

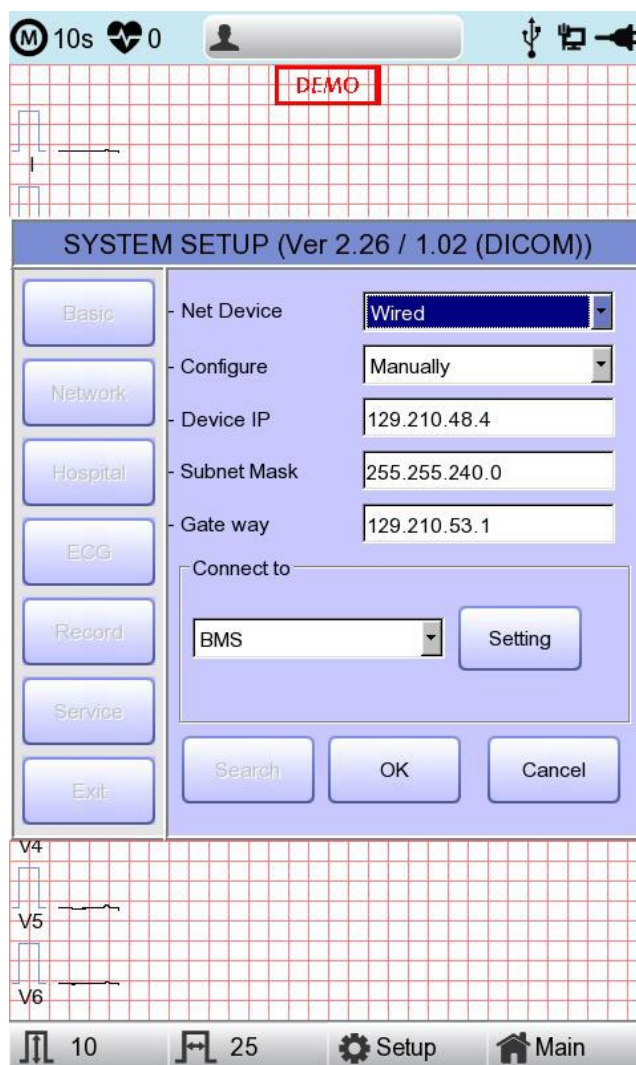

The mode of network connection can be selected as Wired or Wireless in 'Net Device' setup.

The automatic IP(DHCP) or fixed Manually) can be selected through the 'Configure'.

If the Configure is setup as automatic IP(DHCP), the Device IP, Subnet Mask, Gateway value is received automatically from the DHCP server on your network. If the Configure is set to manually, the user has to enter the Device IP, Subnet Mask, Gateway directly.

When selecting one of the 'Device IP', 'Subnet Mask', 'Gate Way', the keypad will show up. Then, input the information required and press 'OK' button to save or 'ESC' to cancel the information.

When selecting one of the 'Device IP', 'Subnet Mask', 'Gate Way', the keypad will show up. Then, input the information required and press 'OK' button to save or 'ESC' to cancel the information.

It allows selecting the server which is available to link with the equipment in the 'Connect to' menu.

After selecting the type of interlocking server, select the 'Setting' button; an appropriate setup window to the choice of server will be displayed.

<b>Note</b>
- When setting up the connection to the PACS Server, the Device IP should be entered manually (manual IP input) and used. When setting up as DHCP, the Device IP can be changed; if the setting is different from the Device IP registered in the PACS Server, it may prevent interworking with the server.

## BMS Server Setting

IP setup on BMS Server-installed PC can be performed by choosing either Automatic IP (DHCP) or Fixed IP (Manually) in 'Configure' setup.

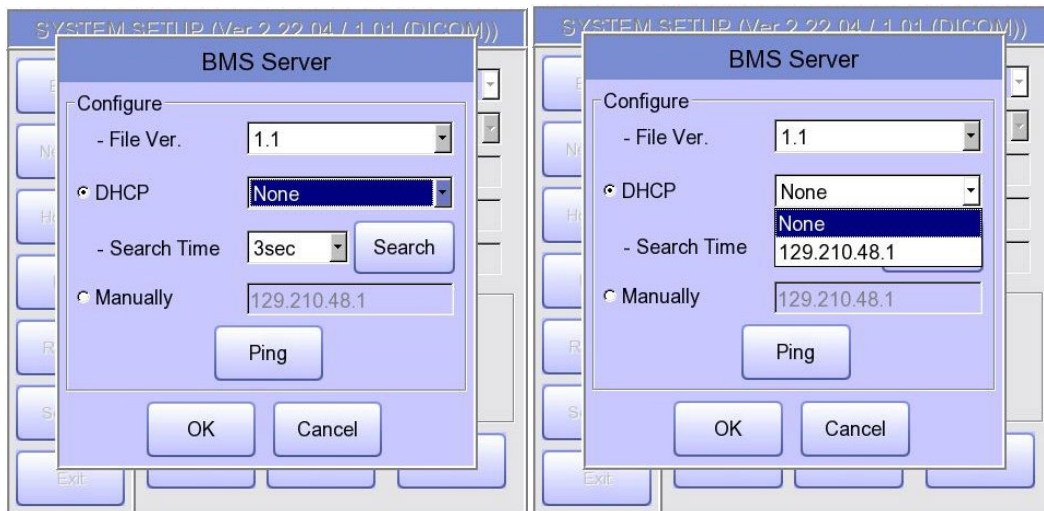

The patient's surname is available after changing the file version to 1.1 in the BMS Server settings.

If you change the file version, all existing patient data will be deleted.

If 'DHCP' is chosen, the IP of the BMS Server-installed PC will be shown on the input box.

Choose the IP of the PC you intend to connect as the IP of a BMS Server-installed PC:

If multiple IPs are displayed, choose one belonging to the PC to connect.

At that time, IP will be shown on the input box only if BMS Server is running on the PC.

If no IP of the intended BMS Server to connect is shown on the input box, choose

'Search' button to conduct an additional search.

If no IP of the intended BMS Server to connect is shown on the input box, choose 'Manual' mode to perform manual input.

### Note

- If you change the file version, patient data and work list data will be deleted.

Upon completion of BMS Server IP setup, the Ping Test can be conducted to check successful network connection. If choosing 'Ping' button, "Ping: 100% Succeeded" message will be shown for a successful connection, whereas "Ping: Failed" message will be shown for connection failure.

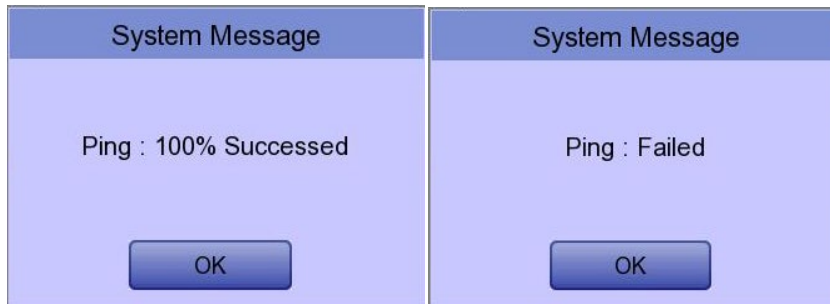
**Note**

- Wired usage is recommended for a BMS Server-installed PC network.
- When setting BMS Server, directly enter the IP of the BMS Server-installed PC by selecting "Manually" if searching with DHCP has failed.

## PACS Server Setting

When selecting the PACS Server, the additional information should be set through the Settings Menu.

The screen for related settings such as the AE Title, IP and Port of Cardio7e/Cardio7, Worklist Server and Store Server will appear.

The screenshot shows the 'PACS SETUP' dialog box with the following fields and values:

- Cardio7**: AE Title: Cardio7, Port: 104
- Worklist Server**: IP: 192.168.70.92, Port: 3000, AE Title: ROOM1, Verify button
- Store Server**: IP: 192.168.70.92, Port: 105, AE Title: PPE, Verify button
- Modality**: ECG: EC, Spiro: PF

Buttons at the bottom: More, OK, Cancel.

When the input window of each item is selected, the keyboard window will appear:

Enter the applicable contents.

When entry is completed, click the "Verify" button so that the connection between the Worklist Server and the Store Server can be confirmed.



When successful, the "Verify: Success" message will appear; when it has failed, "Verify: C-Echo Failed" will appear.

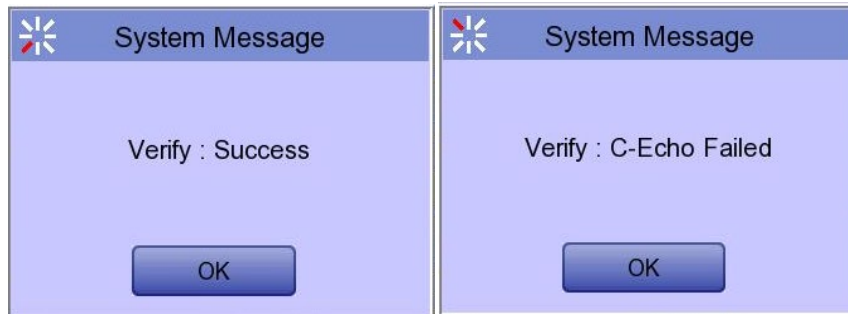

Set the PACS option by pressing the More button when connection to the server is confirmed.

**PACS OPTION SETUP**

**Worklist**

Spiro Exam Code

FVC  SVC  MVV

Date Range

Auto Update Worklist     Auto Return Worklist

**Send Image**

RGB Format     RGB     BGR

Window Width

Window Center

Data Format

Retry Count     Retry Interval

Character Set

### Spiro Exam Code

Enter the Exam Code of FVC, SVC and MVV for the Spiro test.

### Data Range

The range of dates when the worklist is brought can be set at the Worklist Server. You can choose appropriate one from the options such as "Today," "Yesterday ~ Tomorrow", "One Week" and "A Week ago".

For today (today-today), both the start and end dates are set to today, and for today (today-blank), only the start date is set to today to get the worklist.

The screenshot shows the 'PACS OPTION SETUP' dialog box. The 'Date Range' dropdown menu is open, displaying the following options: 'Today', 'Yesterday ~ Tomorrow', 'One Week', and 'A Week ago'. The 'Auto Update Worklist' checkbox is currently unchecked. Other visible settings include: Spiro Exam Code (FVC, SVC, MVV), Send Image, RGB Format, Window Width (256), Window Center (128), Data Format (JPEG), Retry Count (3), Retry Interval (1), and Character Set (Korean(EUC)).

### Auto Update Worklist

If you tick the Auto Update Worklist, the Worklist update will be run automatically whenever you enter the Worklist screen.

### Auto Return Worklist

If you tick Auto Return Worklist, data will be transferred to the PACS Server and the Worklist screen will re-appear automatically by using the Exam button after selecting the patient to measure, or by using the NETWORK key or AUTO key after selecting the patient to measure.

### RGB Format

Select the RGB Format when converting the image to be transferred to the PACS Server. The basic setting shall be "RGB"; if the Grid Color of the transferred file appears as green, it will be converted to the red color when the "BGR" is set.

### Window Width / Window Center

Set the Window Width and the Window Center for the file to be transferred to the PACS Server.

If the image of the transferred file appears blurred, check the Window Width and Center values which the PACS Server supports, and enter them.

**Data Format**

Set the data format for the file to be transferred to the PACS Server. You can select either "JPEG," "PDF" or "RAW" after checking the format supported by the PACS Server.

The screenshot shows the 'PACS OPTION SETUP' dialog box. It is divided into several sections:

- Worklist:** Contains 'Spiro Exam Code' with input fields for 'FVC', 'SVC', and 'MVV'. Below it is a 'Date Range' dropdown menu set to 'Today', and two checkboxes: 'Auto Update Worklist' and 'Auto Return Worklist'.
- Send Image:** Contains 'RGB Format' with radio buttons for 'RGB' (selected) and 'BGR'. Below are 'Window Width' (256), 'Window Center' (128), and 'Data Format' (JPEG). A mouse cursor is pointing at the 'Data Format' dropdown, which is open, showing 'JPEG', 'PDF', and 'RAW' options.
- Retry Count:** A numeric input field set to '3'.
- Character Set:** A dropdown menu set to 'Auto'.

At the bottom of the dialog are 'OK' and 'Cancel' buttons.

**Retry Count**

Select the number of Retransmission attempts when a communication error occurs during transfer of data to the PACS Server.

**Retry Interval**

Select the interval for Retransmission attempts when a communication error occurs during the transfer of data to the PACS Server.

**Character Set**

By selecting the Character Set, multiple selections of language are available; it should be selected according to the character set in order to present contents such as patient information by language when transferring a DICOM file to the PACS Server.

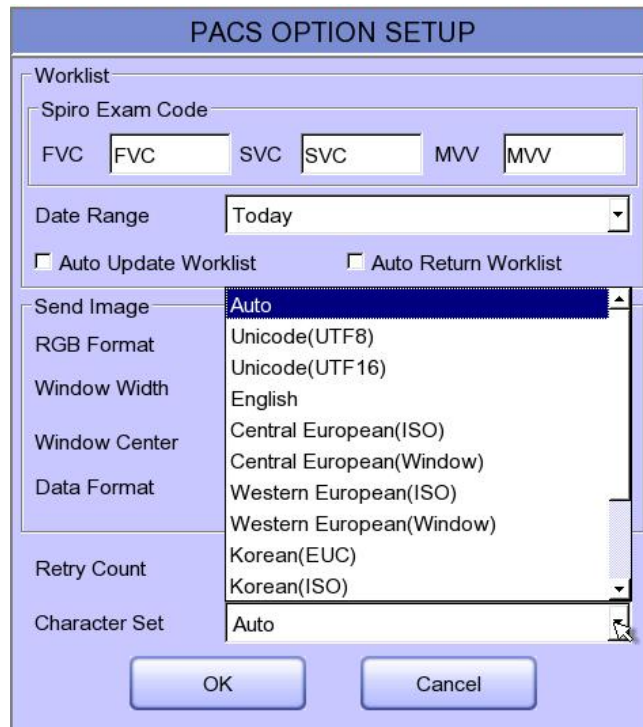

Upon the completion of each setting, press the 'OK' button to save the changes or push the 'Cancel' button or the 'ESC' button of the Operating Panel to cancel them.

## GDT Setting

When selecting GDT, it should be set additional information through the Setting menu.

It shows the menu screen for related settings such as Work type, GDT Directory, Component name, File name, and Image type.

**GDT SETUP**

Work Type  
 Server       Client

Directory  
 Directory Path :  
  
 User ID :   
 Password :   
 Date :

Component  
 Import [EMR,HIS]  
 Name :   
 Short Name :   
 Export [Cardio7]  
 Name :   
 Short Name :

File Name  
 Type :   
 File Name :

Image  
 JPEG       PDF       DICOM

OK      Cancel

### Work type

Set how the GDT function of the system works.

- Server: Cardio7e/Cardio7 receives requests and commands.
- Client: Cardio7e/Cardio7 sends requests and commands.

### Directory

Enter the type format in which the shared folder information and date information to be used by the GDT protocol.

**Component**

For use GDT protocol, enter the EMR name and abbreviation and the name of Cardio7e/Cardio7 and abbreviation.

**File name**

Select the name form of the file to be shared by the GDT protocol.

**Image**

Select the image format of the data file to share with the GDT protocol.

When it selects the Input window for each item, a keyboard window appears, and it can type its contents. If the input is completed normally, a message about the connection success is displayed at the top of the screen.

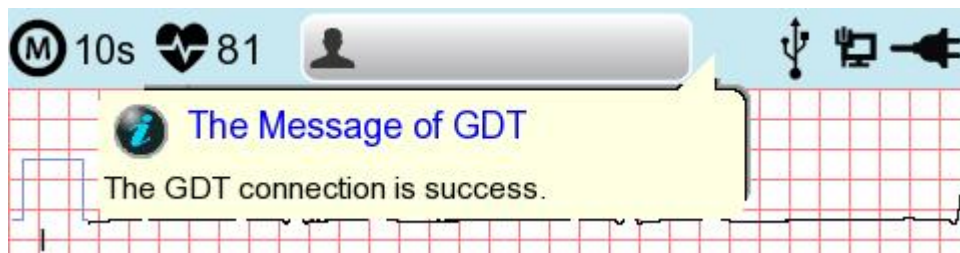

**WEB Setting**

When selecting Web transmission, additional information must be set through the Setting menu.

The screen for related settings such as DNS Server, URL, ID, PW, Path appears.



The screenshot shows a 'Web Server' configuration window. It features a blue title bar with the text 'Web Server'. The main area contains five labeled input fields: '- DNS Server' (with the value '8.8.8.8'), '- URL', '- ID', '- P.W', and '- Path'. A 'Verify' button is positioned to the right of the '- ID' and '- P.W' fields. At the bottom of the window are 'OK' and 'Cancel' buttons.

**DNS Server**

The IP of the server that supports the domain name system.

**URL**

Web address to access.

**ID**

User ID to be used in the web to be accessed.

**PW**

User password to use on the web to be accessed.

**Path**

Path within the server to which to send the file

If you select the input window of each item, a keyboard window appears, and you can enter the content.

After entering, you can check the connection between Worklist Server and Store Server by pressing the "Verify" button.

The message "Verify: Success" is displayed on success, and the message "Verify: Fail" on failure.

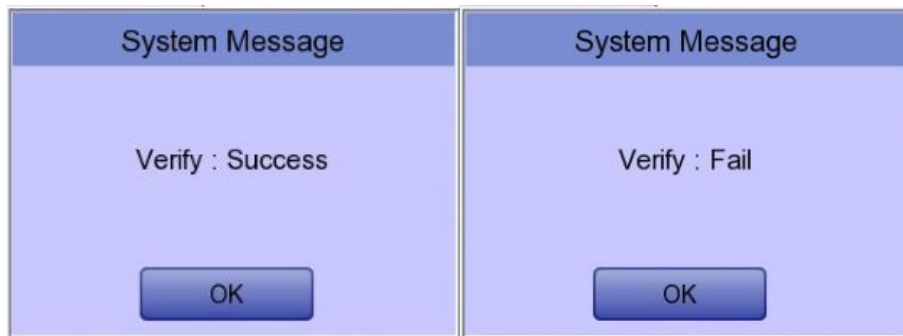

## Wireless Network Setting

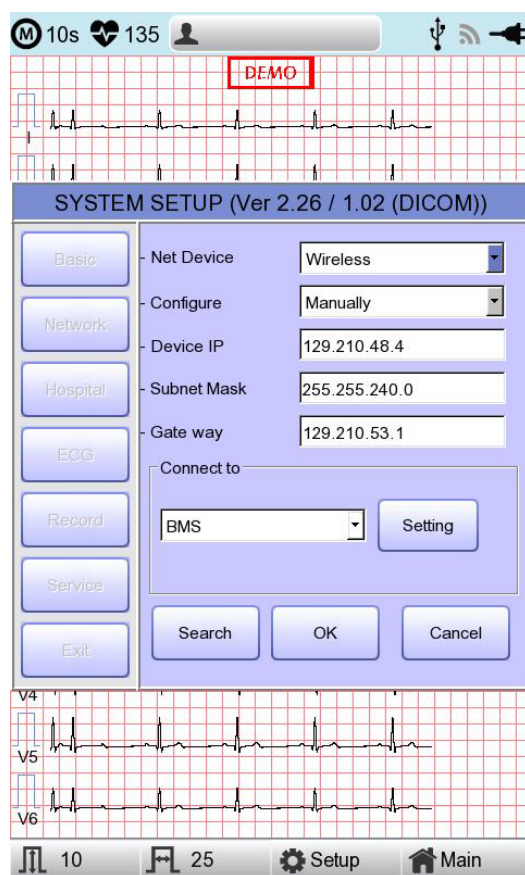

- 1) Connect the USB to the USB port of Cardio7e/Cardio7, and check whether or not the wireless icon (  ) appears in the Status bar on the top of the screen.
- 2) Navigate to System Setup -> Network, and Set the Device as "Wireless".When selection is done properly, the "Survey" button on the bottom will be activated.
- 3) Select the "Search" button to search for the AP. The AP is to be searched automatically when the "Search" button is pressed: the searched AP will appear in the list upon the completion of the search.

### Specifications of Wireless Network USB Adapter Support

Company Name	Product Name
ipTIME	N100mini
	N150UA
	N150U
TP-LINK	TL-WN725N

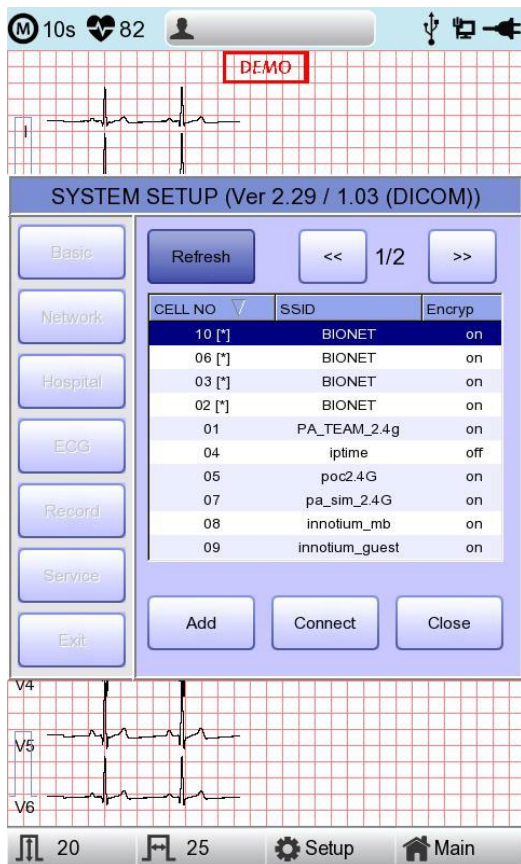

- **Refresh** : AP re-searching
- **<<** : Page up
- **>>** : Page down
- **Connect**: Attempting to connect
- **Close**: Closing the window
- **Add**: Hidden Wi-Fi connection

4) Select the AP to be connected by using the rotary key or touching. Click the "Connect" button. At that time, the security key input window will appear if the "Encrypt" field is "On".

**Add Network**

- Network Name :  
BIONET

- Security :  
WPA/WPA2-Personal

- Password :  
[Empty field]

OK Cancel

If you want to connect to Hidden Wi-Fi, click the Add button and manually enter the network name before proceeding.



The screenshot shows a dialog box titled "Add Network". It has a light blue background and a darker blue header. The header contains the text "Add Network". Below the header, there are four input fields, each with a label and a text box:

- Network Name :
- Security :
- Identity :
- Password :

The "Security" field has a dropdown menu that is currently open, showing "WPA/WPA2-Enterprise". At the bottom of the dialog, there are two buttons: "OK" and "Cancel".

#### Note

The user should set the AP Search and Security Key in order to use the wireless network. If there is no security set on the AP to be connected, it will be connected automatically without Security Key setting. In the event that there is an automatic connection to the AP without Security Key setting, the safety of network communication is not guaranteed.

- 5) After clicking the Key Value input line by using the rotary key or touching, enter the security key.
- 6) Upon the completion of input, click the "OK" button; Connection will be attempted and the message describing the connection status will appear.

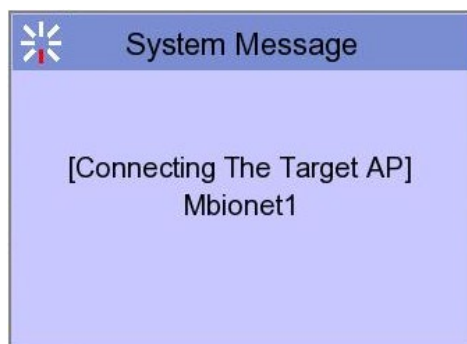

- 7) When the message reporting a proper connection appears, click the "Close" button.

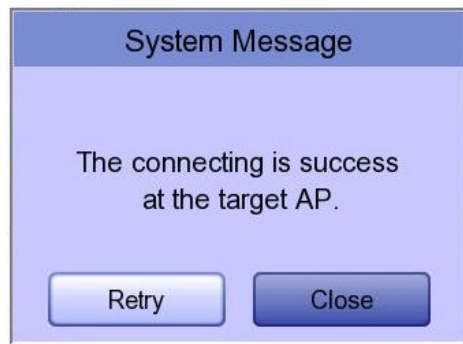

When connection is successful, the wireless icon on the status bar at the bottom of the screen will be changed into .

- 8) If connection fails, connection can be re-attempted by pressing the "Retry" button. If connection keeps failing, check the AP and the USB-TO-WLAN status.



9) When connection with the AP is successful, set the Device IP, Subnet Mask, Gateway, etc. by selecting manually or Configuring with DHCP. Refer to the Network Setup part of the User Manual for more details.

#### Note

It is recommended to use English for the name of the AP wireless network (SSID). If it is entered in Korean or other languages, Mojibake or illegible characters can appear.

#### Note

- It is recommended connecting up to eight the same network under normal AP status.
- Due to the nature of wireless, connectivity may be poor depending on the environment.

## Hospital Setup

When selecting the 'Hospital' menu at the left side of the Setup page, Hospital Setup page will show up at the right side.

You can input the names of the hospital and doctor.

When clicking the area to input the information, the keypad will show up. Then you can input the information required and press OK button to save or ESC to cancel the information.

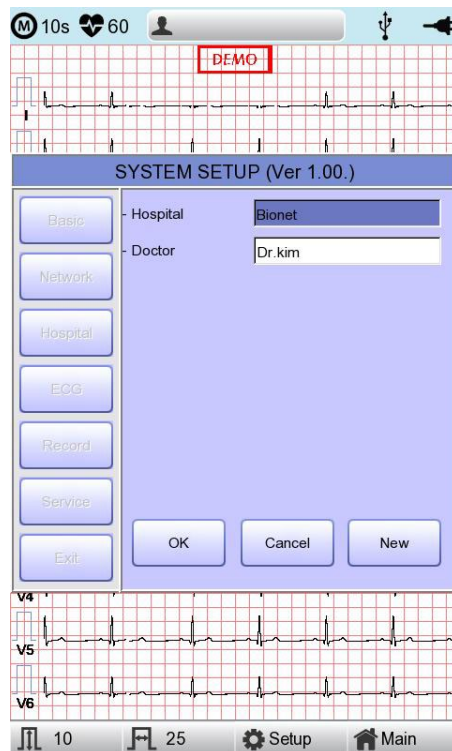

## ECG Setup

When selecting the 'ECG' menu at the left side of the Setup page, ECG Setup page will show up at the right side.



## Printing channel setting [Print Setup]

### [Monitoring Form]

Set up real time-printout form. Click 'Mon Form,' and then a POP-UP window for channel list will be displayed. Default is set as '12CH'.

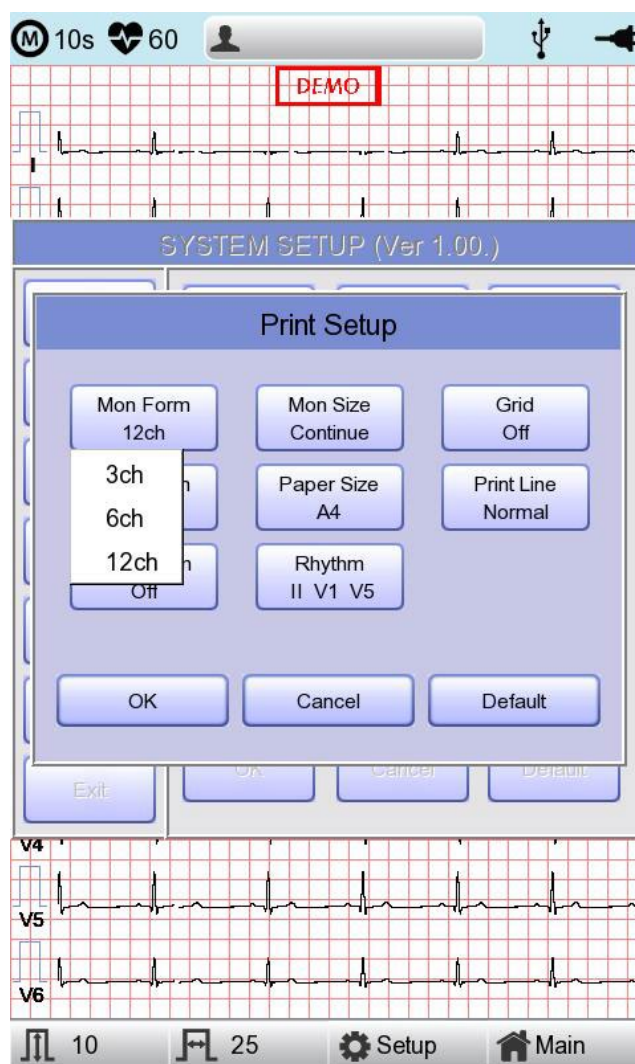

- 3CH printing: To print 3 channels at the same time (I ~ III / aVR ~ aVF / V1 ~ V3 / V4 ~ V6) If you want to change the channel, press 'RHYTHM' on the control panel.
- 6CH printing: To print 6channels at the same time (I ~ aVF / V1 ~ V6) If you want to change the channel, press 'RHYTHM' on the control panel.
- 12CH printing: To print 12channels at the same time (I ~ V6)

#### NOTE

At 3CH and 6CH setup, 'RHYTHM' key will become active only if 'Mon Size' is set as 'Continue.'

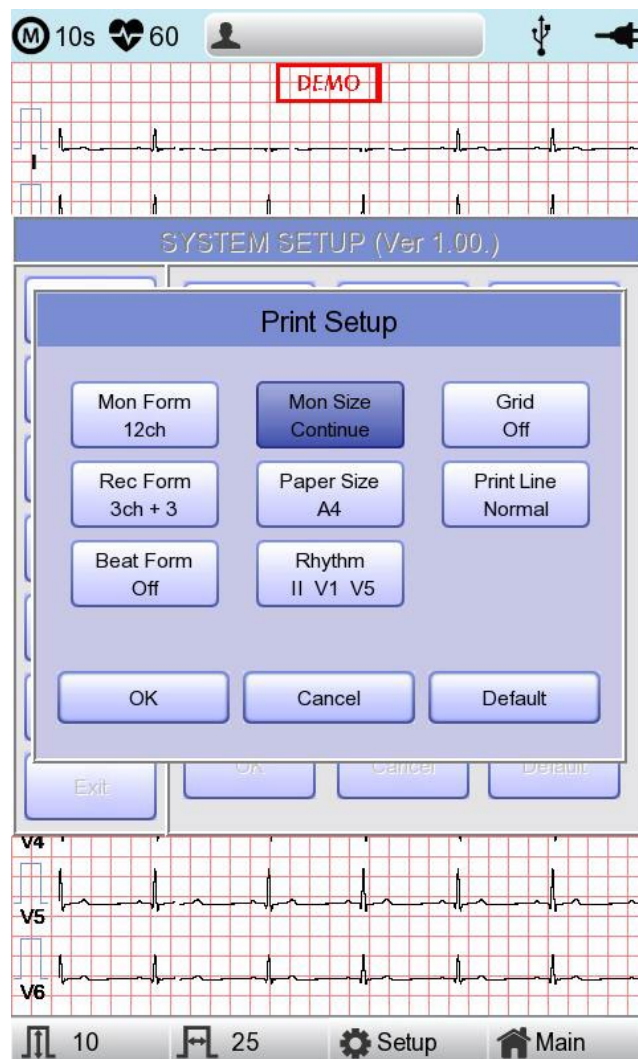
**[Monitoring Size]**

You can set up the real time printing size. When you click the 'Mon Size' menu, 'Report' will be selected and when clicking it again, 'Continue' will be selected. Default is set as 'Continue'.

- 'Report': To print out 10-second data in the form of Report.
- 'Continue': The leads will be printed out continuously until you press the 'ESC' key on the control panel.

**NOTE**

Output speed will be 25.0mm/sec if 'Mon Size' is set as 'Report.'

**[Grid]**

If general fax paper is used for printout, it needs to be marked with a grid. A 5mm X 5mm grid must be in a solid line with the point mark on the 1mm X 1mm location. If using standard ECG recording paper instead of general fax paper (thermal paper), undo the grid marking setup as the recording paper will already have it.

The grid marking setup can be done using output format selection mode. Press rotary key or touch the intended field to select among the Grid selection items, and then the setup will be modified as ON or OFF. If ON, the grid marks will be printed out; if OFF, it will not be printed out.

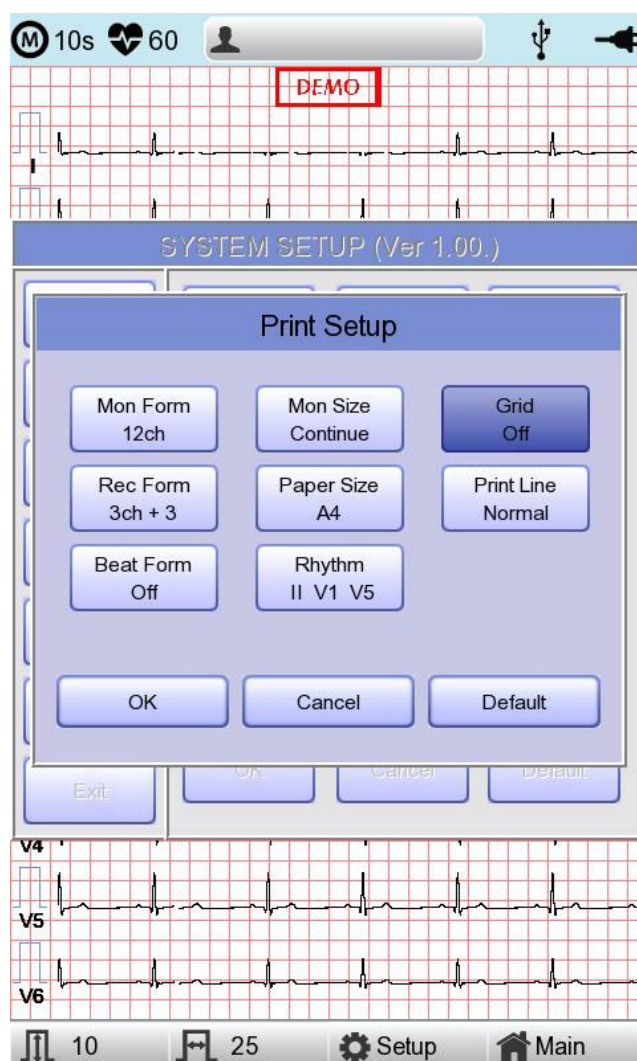

**[Recording Form]**

You can set up the recording form.

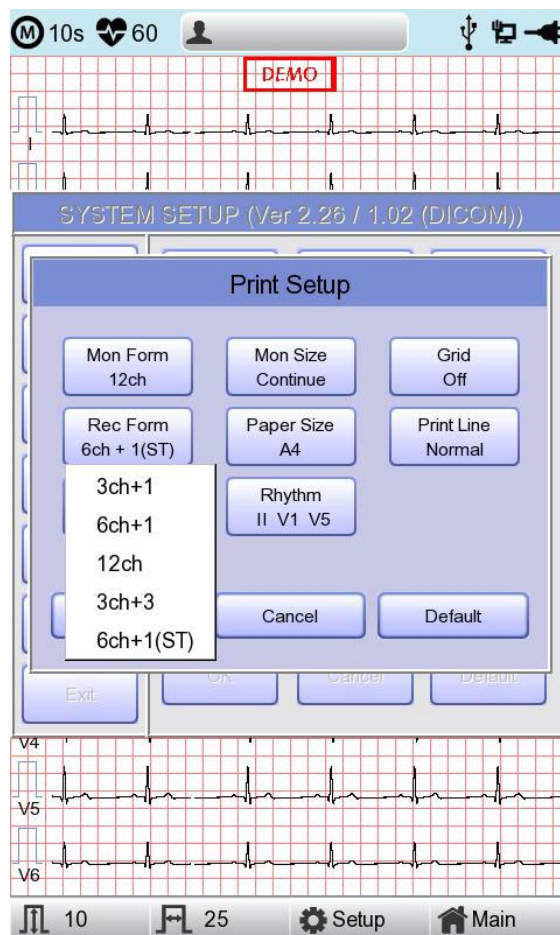

If you choose the 'Rec Form' menu, a small POP-UP menu will appear below; once you choose either 3CH+1, 6CH+1, 12CH or 3CH+3, the POP-UP menu will disappear. The default is '3CH+3'.

- '3CH+1': 10-second ECG will be recorded as I, II and III for the first 2.5 seconds, aVR, aVL and aVF for the next 2.5 seconds, V1, V2, V3 for the next 2.5 seconds and V4, V5, V6 for the next 2.5 seconds. 1 channel of rhythm will be recorded for 10 seconds at the bottom.
- '6CH+1': 10-second ECG will be recorded as I, II, III, aVR, aVL and aVF for the first 5 seconds and V1, V2, V3, V4, V5 and V6 for the next 5 seconds. 1 channel of rhythm will be recorded for 10 seconds at the bottom.
- '12CH': 12-channel rhythm will be recorded as I, II, III, aVR, aVL, aVF, V1, V2, V3, V4, V5 and V6 at the same time for 10 seconds.
- '3CH+3': 10-second ECG will be recorded as I, II and III for the first 2.5 seconds, aVR, aVL and aVF for the next 2.5 seconds, V1, V2, V3 for the next 2.5 seconds and V4, V5, V6 for the next 2.5 seconds. 3 channels of rhythm will be recorded for 10 seconds at the bottom.

- '6CH+1(ST)': 10-second ECG will be recorded as I, II, III, aVR, aVL and aVF for the first 4 seconds and V1, V2, V3, V4, V5 and V6 for the next 4 seconds. 1 channel of rhythm will be recorded for 10 seconds at the bottom. The amplitude of the measured ST wave is printed as an ST map. It is printed at 25mm/sec regardless of output speed

The set value will be displayed on the screen, and when you choose '3CH+1', 3 Channels + 1 Rhythm Report will be shown at the top of the printing form, '6CH+1' for 6 Channels + 1 Rhythm Report, '12CH' for 12 Channels Rhythm Report, '3CH+3' for 3 Channels + 3 Rhythm Report will be shown.

### [Paper Size]

You can set up the paper size. When you click the 'Paper Size' menu, 'A4' will be selected and when clicking it again, 'Letter' will be selected. Default is set as 'A4'.

- 'A4': to output at 297mm for A4 Size printout.
- 'Letter': to output at 279 mm for Letter Size printout.

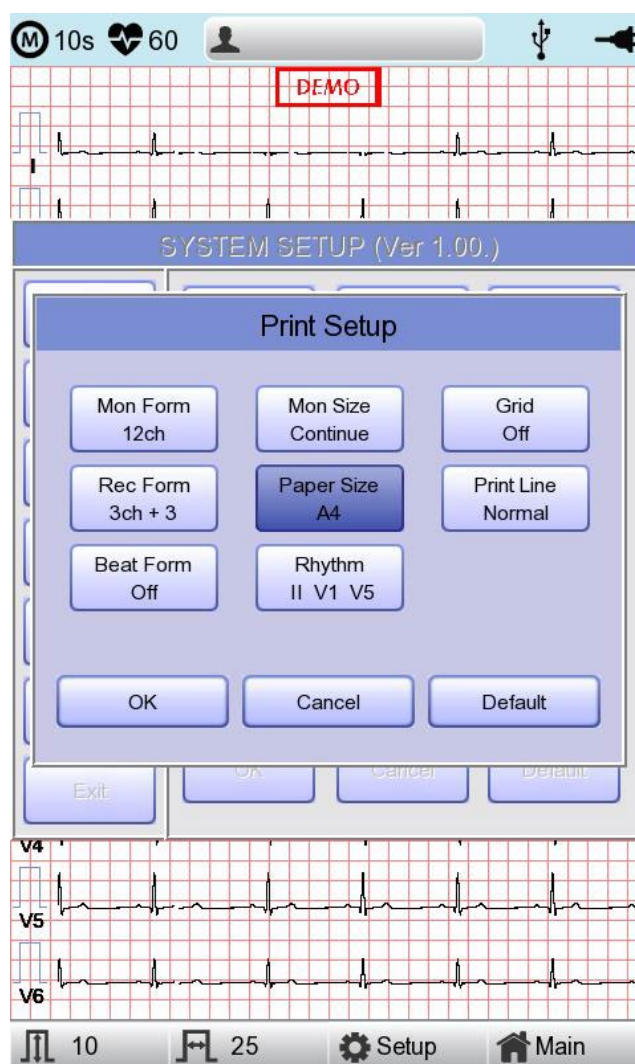

**[Print Line]**

You can set the line thickness of the printouts. Three setting options are available: "Thin", "Normal" and "Thick".

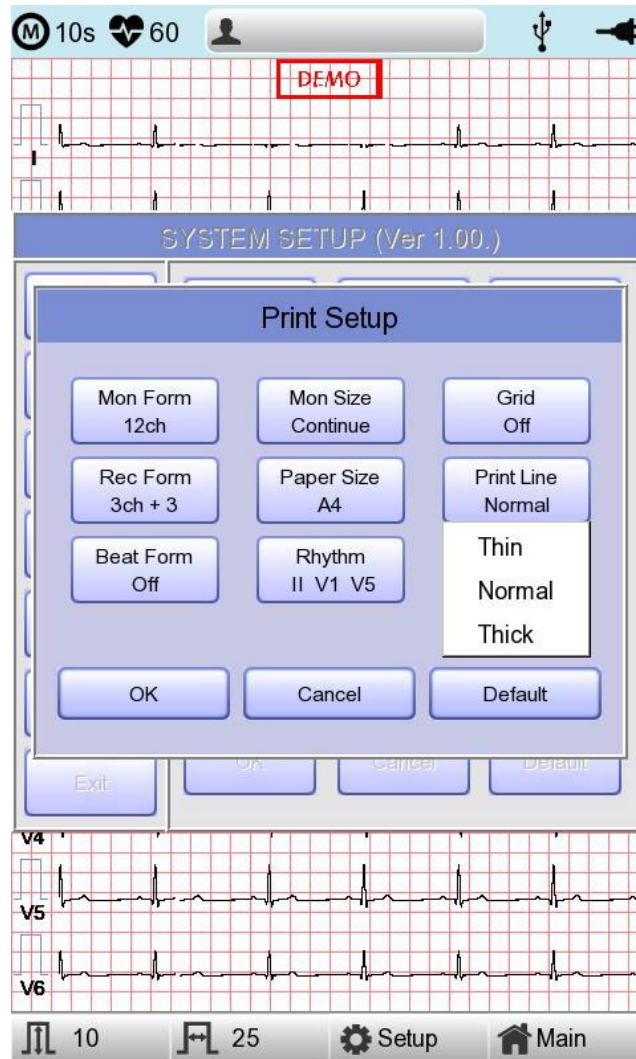

**[Beat Form]**

You can set up the additional beat report printing.

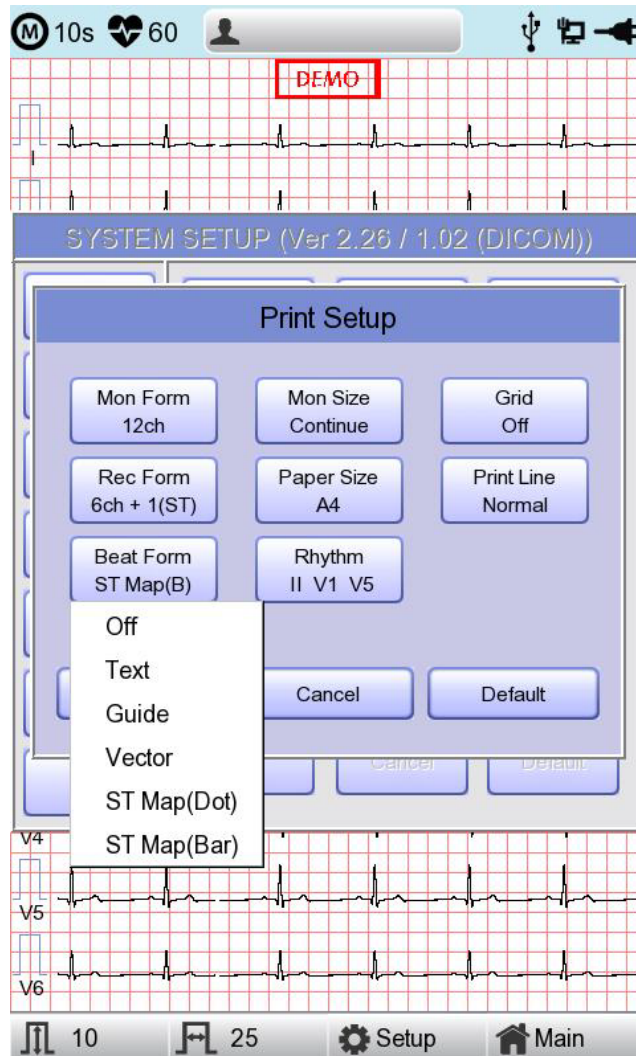

When you select the 'Beat Form' menu, a small POP-UP menu will appear at the bottom and it will disappear when choosing OFF, Text, Vector, Guide, ST Map(Dot) or ST Map(Bar).

Default is set as 'OFF'.

Beat report will be attached to the printing form of channels of '3CH +1', '6CH +1', '12CH', '3CH +3' and '6CH +1(ST)'. It will record every important result by marking the representative waveform of each form.

**[Rhythm]**

You can set up the rhythm leads for printing out the diagnosis of 3CH+1, 6CH+1, 3CH+3 and Long Time (1,3,5,10 Minute). You can choose 3 rhythm leads and when '3CH+3' is chosen, you can use all of the 3 leads, while when '3CH+1', '6CH+1' or 'Long Time' is chosen, you can use the first value only.

Default is set as 'II, V1, V5', so when 3CH+1, 6CH+1 or Long Time is chosen, you can use the lead 'II' and 3CH+3 for lead 'II, V1, V5'.

If you choose 'Rhythm' menu, 'Rhythm Channel' window will be displayed as shown below.

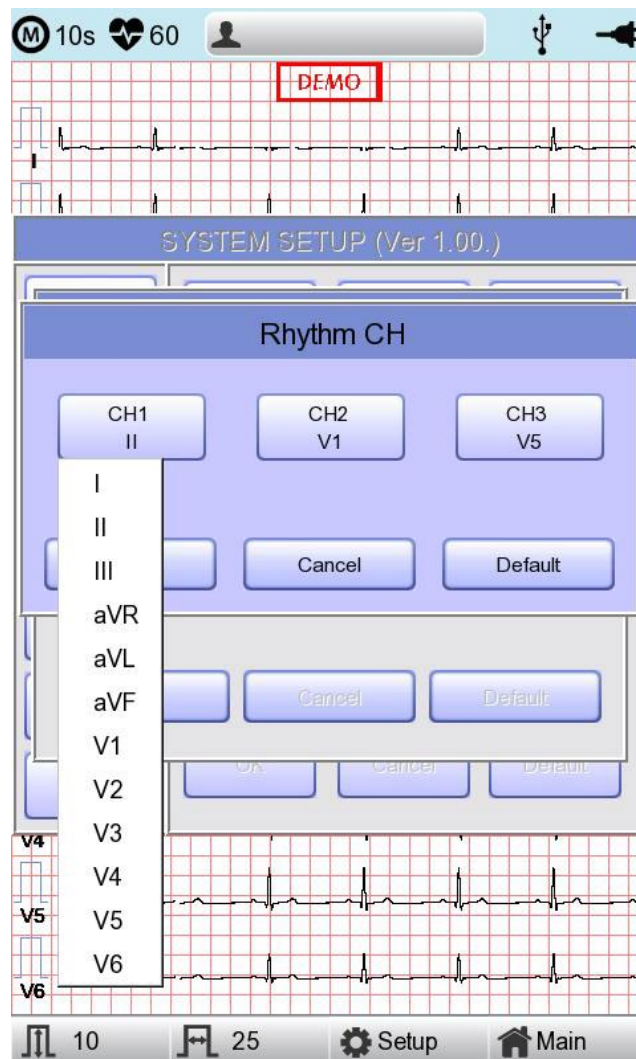

At that time, select either the 'CH1,' 'CH2' or 'CH3' menu; and then choose one from Lead I ~ V6 in the select menu.

**[Preview]**

After performing measurements by using keys such as RECORD, AUTO and NET, the device can automatically show the outcome to the user. This function can be turned On or Off in this window.

When the preview setting is set to "On", the "Preview" screen will appear following data collection with RECORD, AUTO and NET keys. While "Preview" screen is showing, the user can perform print, save or transmit the data after clicking [OK], or no action after selecting [Cancel]



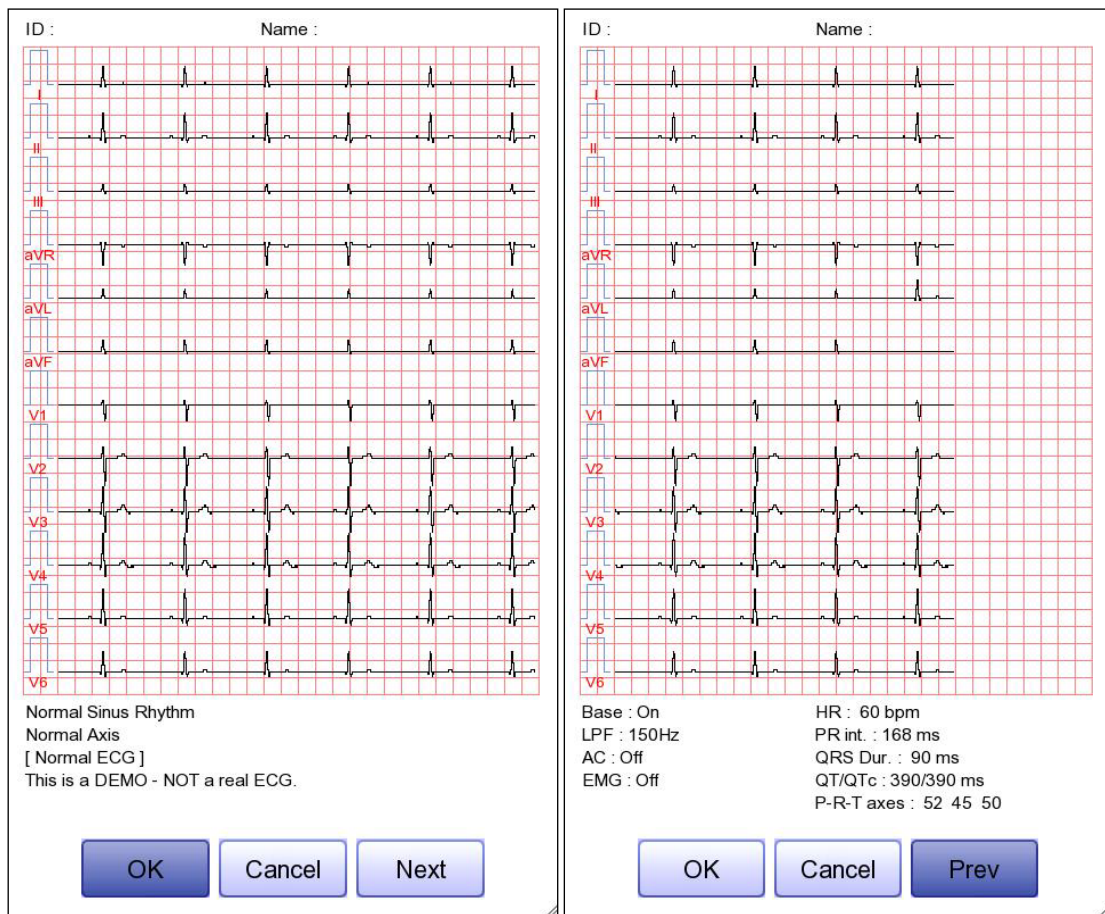

- The first page: ECG 0 - 6 seconds signal data, ID, Name, and Diagnosis
- The next page: ECG 6 - 10 seconds signal data, ID, Name, Filter setup, Rhythm parameter values

#### Note

The preview screen will be shown with output speed set to 25mm/sec.  
The preview screen is available for 10-second recording only.

**[Quick Print]**

Set up the Quick Print Options. Output time can be saved by using the buffering function during selection of 0 - 10 seconds.

**Note**

- If setting up as ON, diagnosis button should be used only after signalling is stabilized. Upon ON setup, diagnosis and output can be affected if the saved data is not stabilized; this is because the data is retained before use for as long as the time set up.
- Quick Print Options are available for 10-second recording only. They are not available for Long Time (1, 3, 5 and 10 min.) recording.

## [Filter Setup]

The signal output generated by the device may contain extra unwanted signals in addition to the EKG wave such as AC noise, baseline drift caused by respiration, noise generated by an electrical field nearby, etc. Applying filters could help to reduce or remove those unwanted signals from the output of the device.

To change filter information, enter the Filter Setup Menu either by moving the selection block over and select it using the rotary key or by touching the menu on the touch screen.

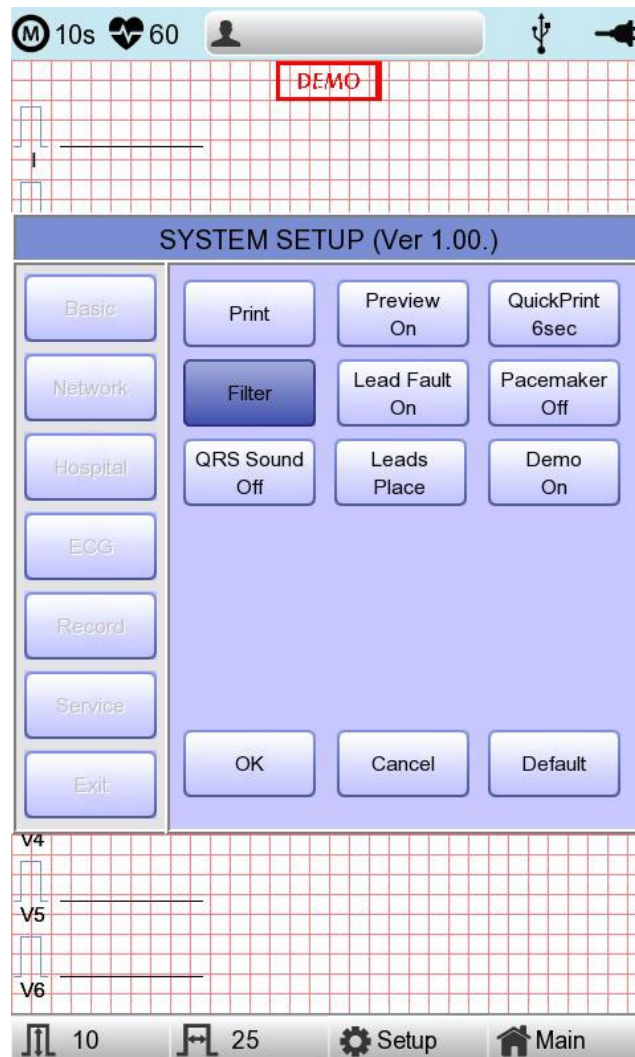

Upon selection, the Filter Setup menu, shown below, will appear. Use either the rotary key or touch screen to navigate and select menu items to edit. After editing, OK must be selected in order to apply the changed value.

Baseline drift is caused by the patient's breathing. It can be seen as ECG signals being overlapped on a large parabola. The Baseline filter provides 0.05Hz, 0.1Hz and 0.2Hz, and its set values will appear as Base:0.05Hz, Base:0.1Hz and Base:0.2Hz at the bottom of the Output Form.

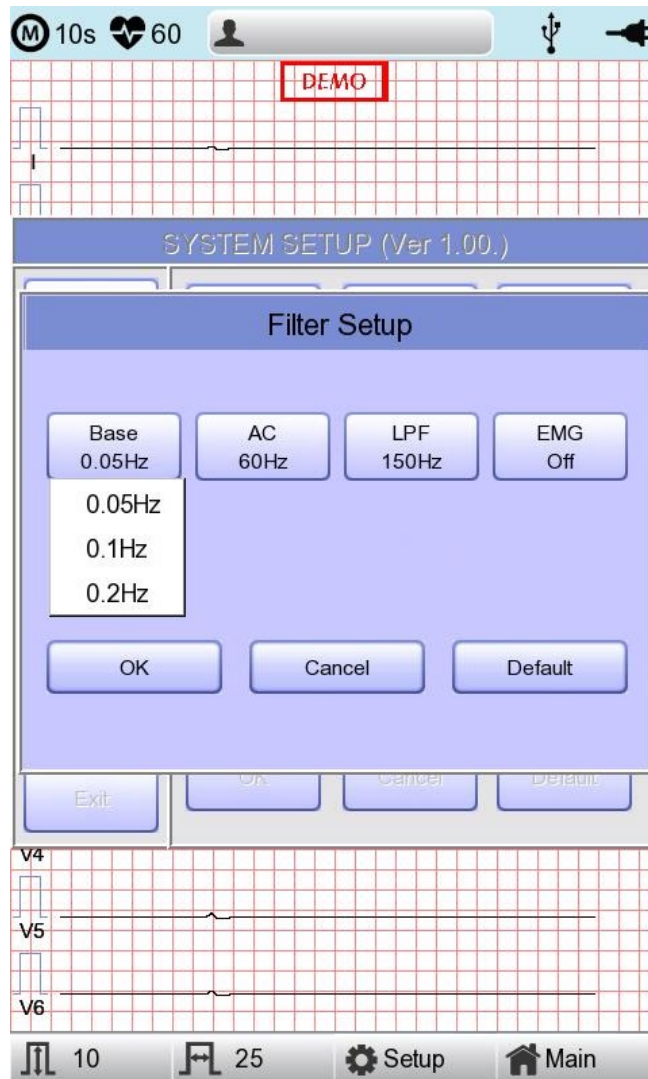

There are three types of an AC power noise filter: 60Hz, 50Hz and OFF. When set to OFF, the filter will not be applied. If the filter is set to 50Hz or 60Hz, then the AC filter will remove 50Hz or 60Hz power noise correspondingly. In the U.S., the AC filter should be set to 60Hz. Check the properties of your power source before setting AC filter properties.

Under battery power, there would be no AC noise being generated. In this case, please set the AC filter setting to OFF so that output signal would not be distorted.

The status of the AC filter can be checked on the bottom part of the printout - indicating AC 60Hz, AC 50Hz or AC OFF

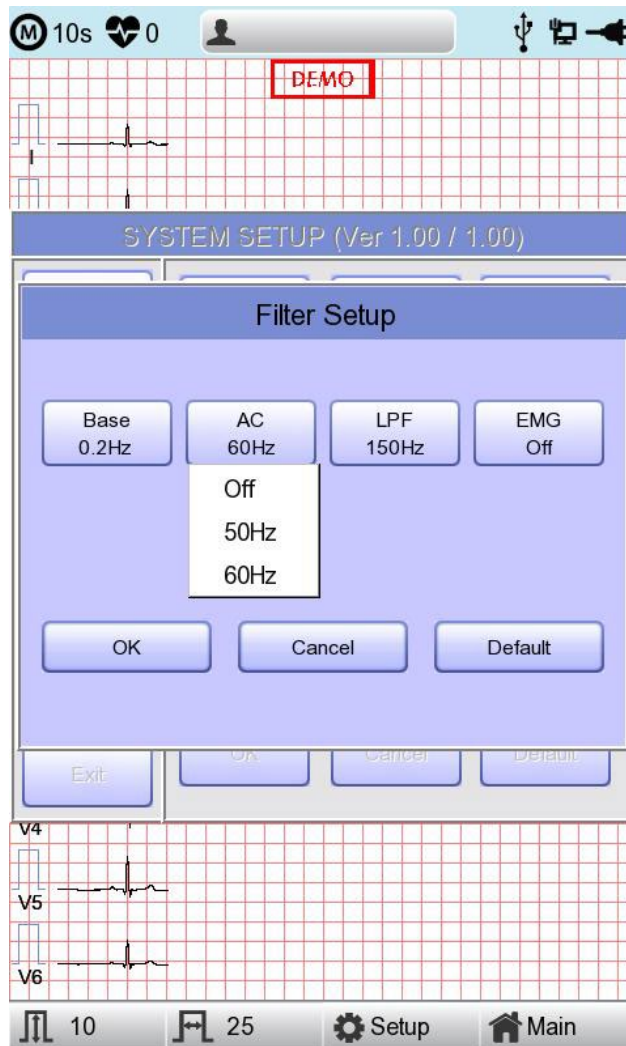

If the recorded EKG signal contains a lot of noise, Low Pass Filter (LPF) may help to clear it. For Low Pass Filter, 40Hz, 100Hz, 150Hz and OFF option is offered. Here, 40Hz option means the filter will remove any unwanted signal with frequencies above 40Hz. Low Pass Filter values will appear on the bottom of the printout form; if LPF setting is OFF then as LPF: Off; if the LPF setting is 40Hz then as LPF: 40Hz; if LPF setting is 100Hz then as LPF: 100Hz; if LPF setting is 150Hz, then as LPF: 150Hz.

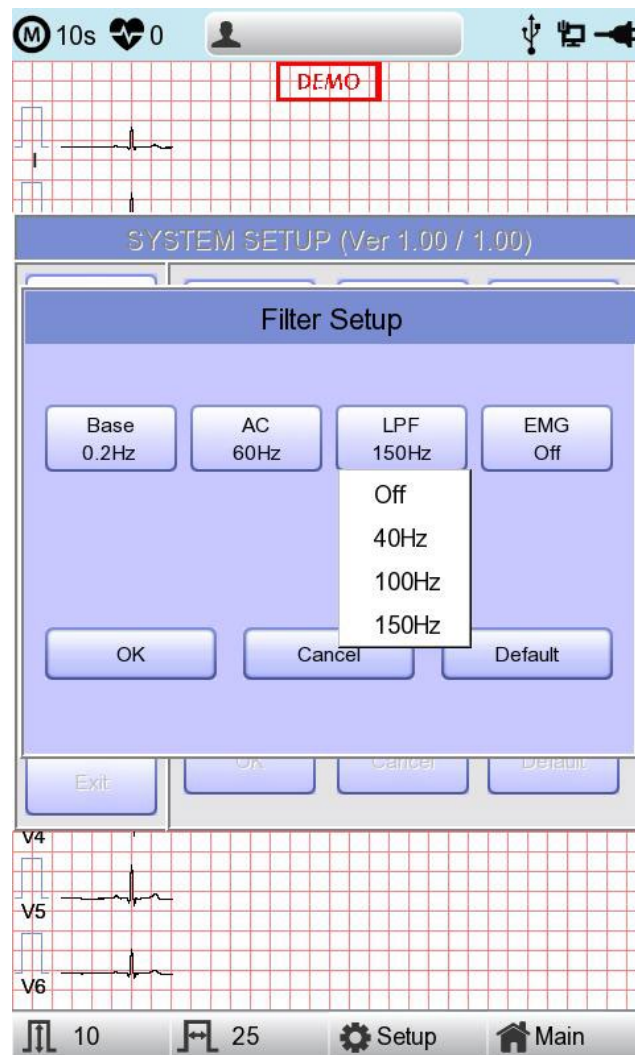

Select 'ON' when applying 'EMG' filter; otherwise, select 'OFF.' Setup values will be shown on the bottom of the printout form as 'EMG: On' or 'EMG: Off' when applying the filter.

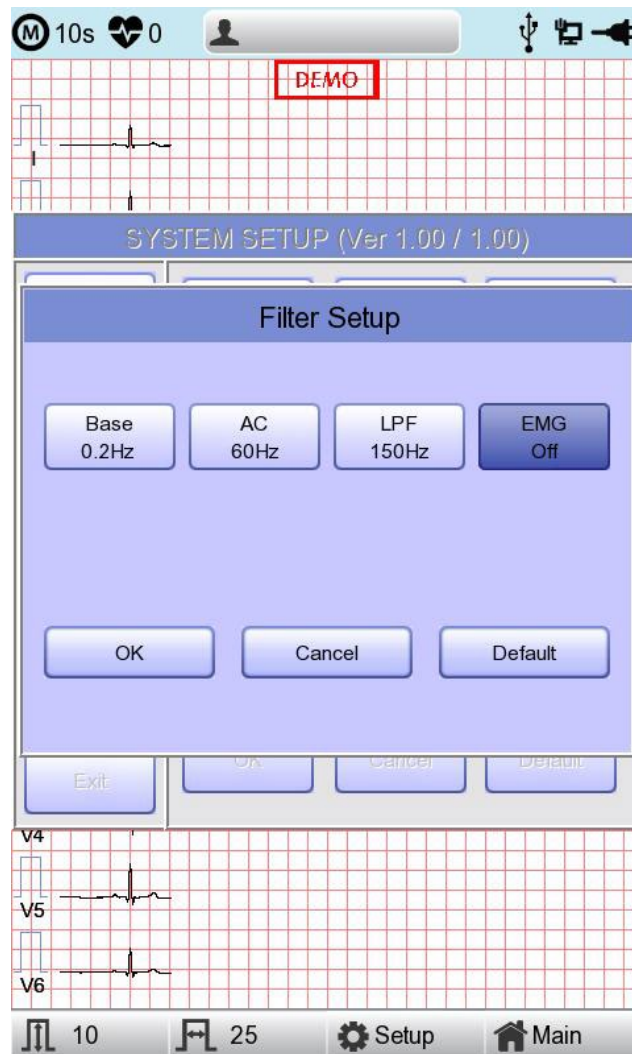

#### NOTE

Applying filters may distort the original signal. Therefore, the proper use when the recording signal is in bad condition can reduce ECG signal distortion.

Referentially, it is recommended to apply the Baseline Drift filter and AC filter all times and that the Near Field filter is used properly. It is also recommended that the LPF be set to 150 Hz for diagnostic outputs.

## Lead fault Signal Display Setting

When the connection between the patient and Leads is improper, lead fault can occur. In that case, you can choose whether to have the lead fault message on the ECG Main page or not. Selecting 'Lead Fault' menu will switch between ON and OFF in the menu, with ON turning on the message display and OFF switching off the message display.

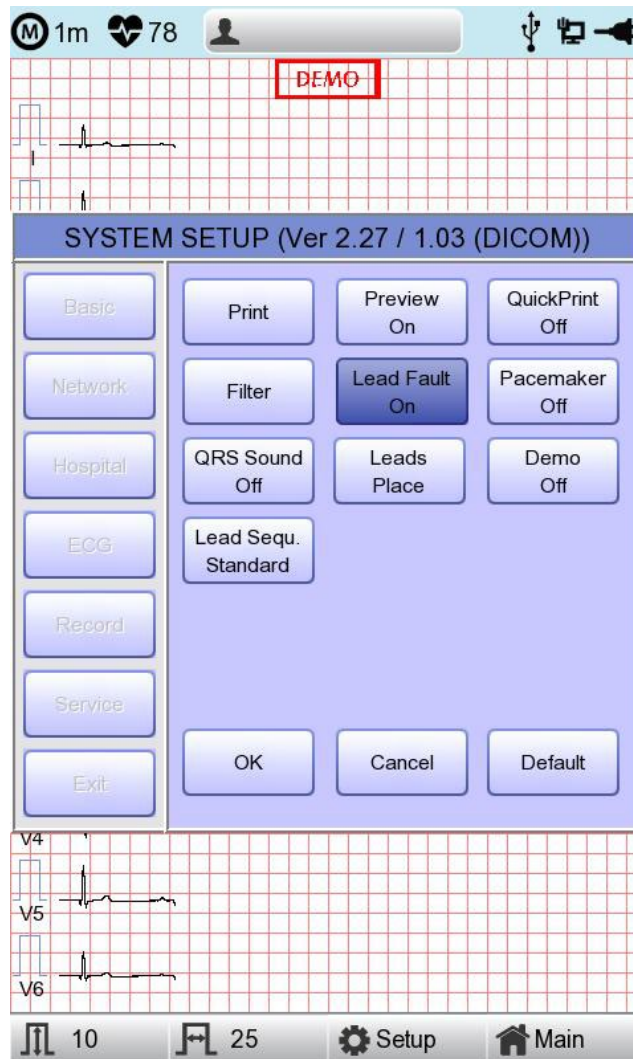

The following message for Lead Fault will be shown with affected channels:

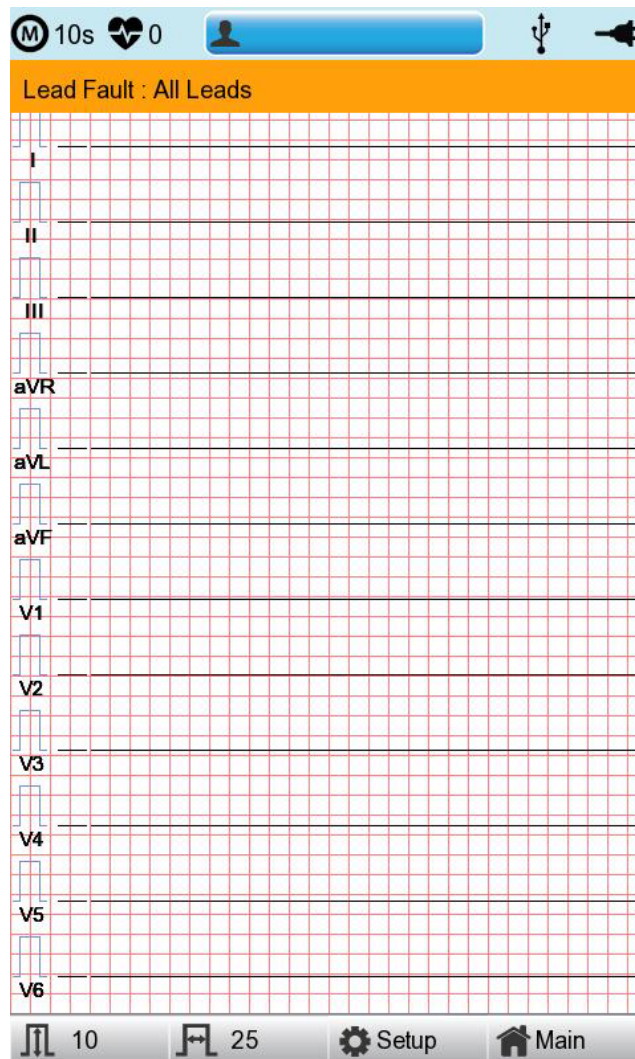

#### Note

- If 'RA' Lead becomes Fault, the wave types of all Leads will not be indicated.
- If 'LA' Lead becomes Fault, the wave types of I and V1-V6 Leads will not be indicated.
- If 'RA' Lead becomes Fault, Lead Fault message might not be shown, and the wave types of all Leads might be indicated.
- If 'LL' Lead becomes Fault, the wave type of II and V1-V6 Leads will not be indicated.
- If a Lead Fault occurs during monitoring or recording, a buzzer alarm will sound, and the message box will pop up.
- No pacemaker signal may be detected. Additionally, if a Lead Fault occurs, please re-measure the EKG as it could have affected the measurement by the device.

### Pacemaker signal printing

In case of using the pacemaker signals, you can choose whether to print out the location of the pacemaker when monitoring or recording.

You can select ON or OFF by clicking the 'Pacemaker' item. When it is on, the location of the pacemaker will be printed out, while when it is off, it will not be printed out.



#### Note

- It is recommended to set the pacemaker off for normal use and only when the patient uses a pacemaker, set it on.
- When having a Lead Fault, the Pacemaker signals may not be detected.

## QRS Sound Setup

In this menu, users can set the device to ring an alarm sound when a QRS beat has generated while it is in waiting mode. Users can either set the alarm ON or OFF by selecting the menu with ON turning on and OFF turning off the alarm sound.



### Note

No sound will ring while printing even when the QRS sound is set to ON.

## Method of Leads Place

'Leads Place' menu shows how to connect electrodes on the graphic display. Focusing on and selecting 'Leads Place' menu will bring the screen shown below. At that time, enter the screen-touch, rotary or 'ESC' key; and then the 'how to connect electrodes' screen will disappear while going back to the 'ECG Setup' setup window.

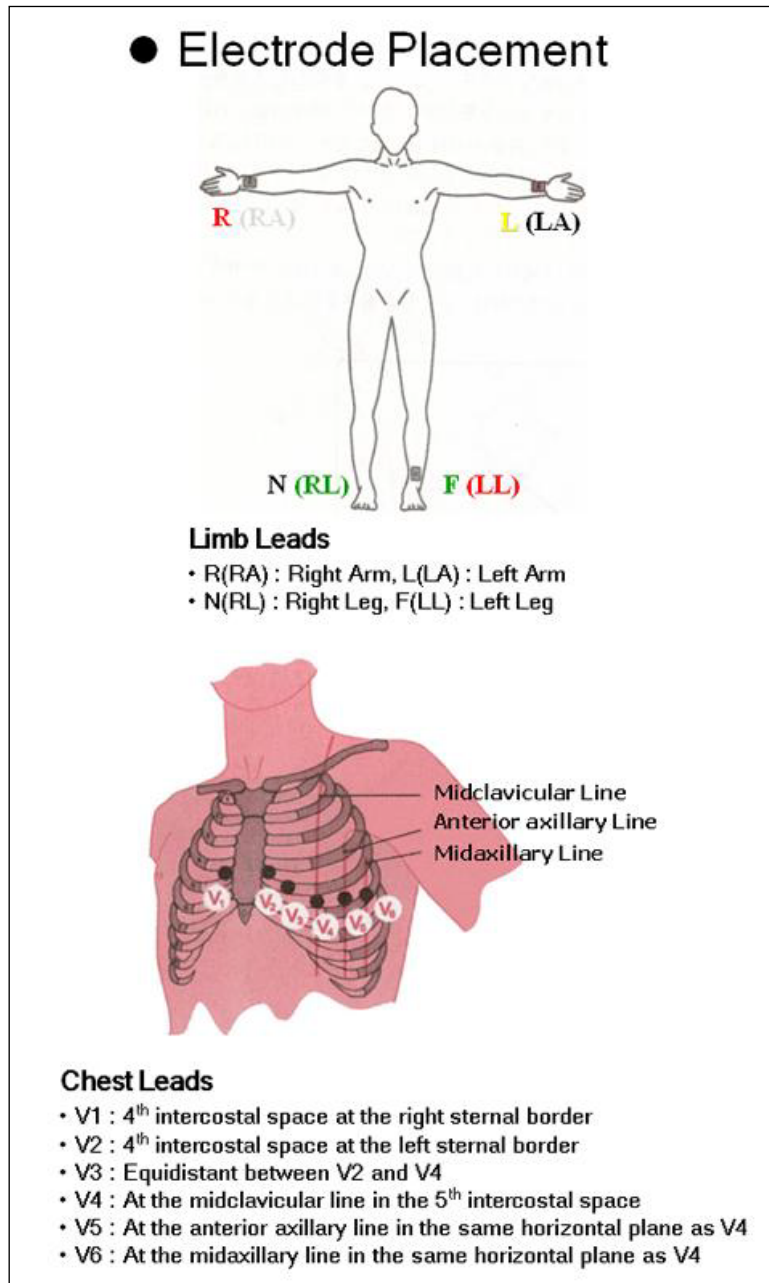

### Demo Mode Setting

This menu puts Cardio7e/Cardio7 in demo mode. When it is set to ON, 60bpm Sinus Normal Rhythm signal will be displayed on the device and DEMO sign will appear on the upper part of the LCD screen. Users can test rhythm, diagnostic, copy printing functions as well as PC communication and other miscellaneous functions in Cardio7e/Cardio7.

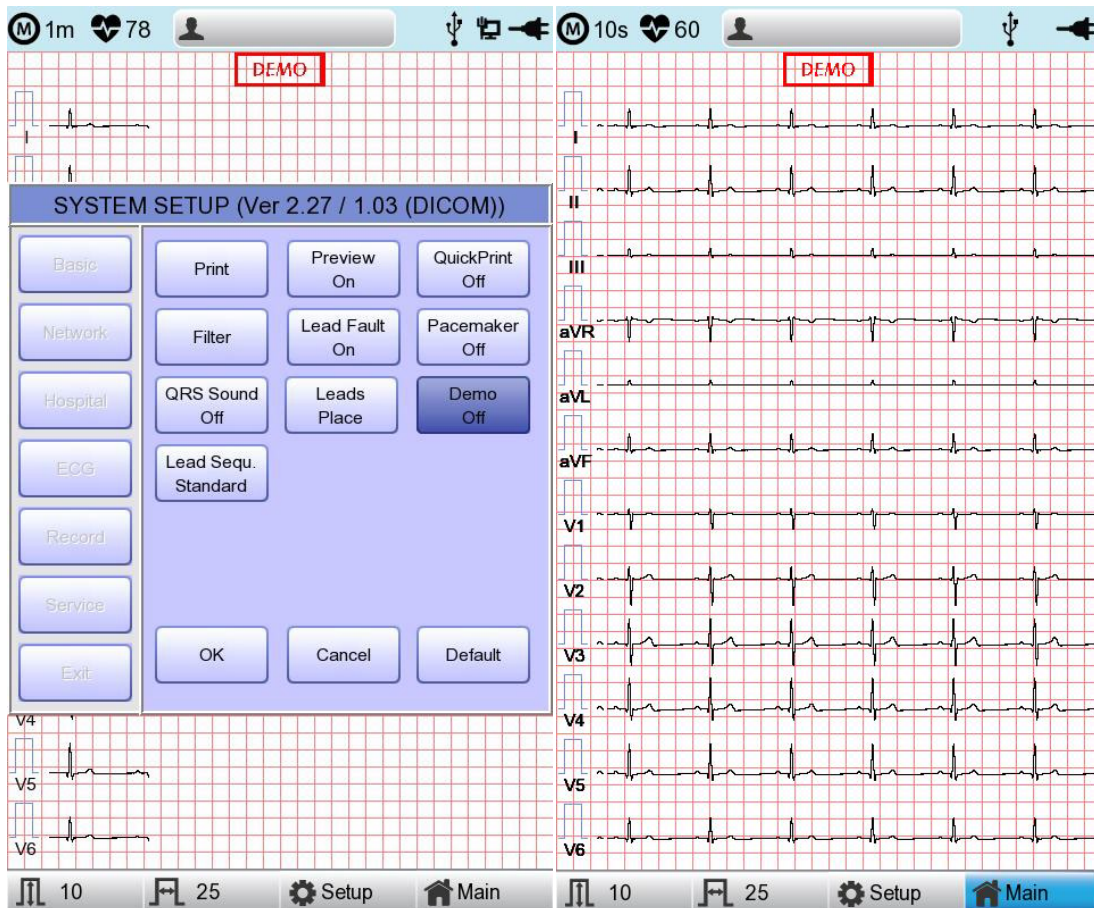

## Lead Sequence Setting

In this menu, users can set the display formats for the lead sequence. Users can either set the Standard or the Cabrera by selecting the menu.

- Standard : The limb leads are indicated: I, II, III, aVR, aVL, aVF
- Cabrera : The limb leads are indicated: aVL, I, -aVR, II, aVF, III



## Record Setup

When selecting the 'Record' menu at the left side of the Setup page, the record setup page will show up at the right side.

Record Setup menu consists of the 'AUTO' key on the control panel setup item and auto diagnosis setup item.

### 'AUTO' key setting

When the 'Store' menu has the focus, click it to set up 'Yes' or 'No'.

When 'Yes' is selected, you can operate the ECG test by pressing the 'AUTO' key on the control panel and the ECG data will be automatically saved, but when 'No' is selected, the ECG data will not be saved. Default is set as 'Yes'.

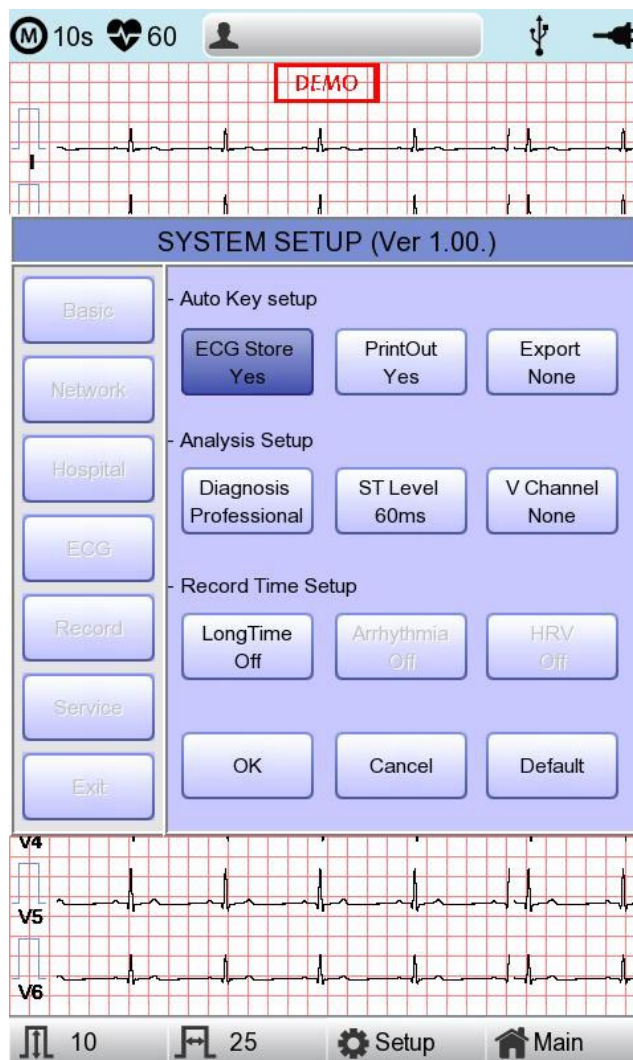

When the 'Print Out' menu has the focus, click it to set up 'Yes' or 'No'.

When 'Yes' is selected, you can operate the ECG test by pressing the 'AUTO' key on the control panel and the ECG data will be automatically print out, but when 'No' is selected, the ECG data will not be printed out. Default is set as 'Yes'.

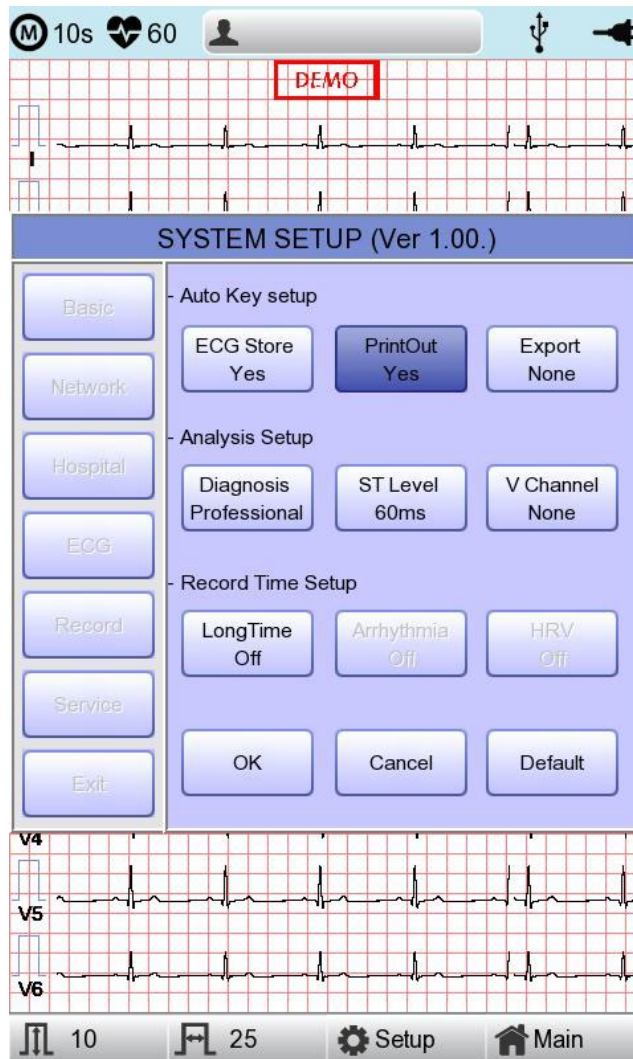

When selecting the 'Export' menu, a small menu window as below will appear and it will disappear when selecting one of None, Server, USB.

If it is 'None,' ECG data will not be externally transferred; if it is 'USB,' ECG data will be automatically saved to the external USB memory. In addition, if it is set up as 'Server,' data will be automatically transferred to PC Server IP among Network options. (Default: None)

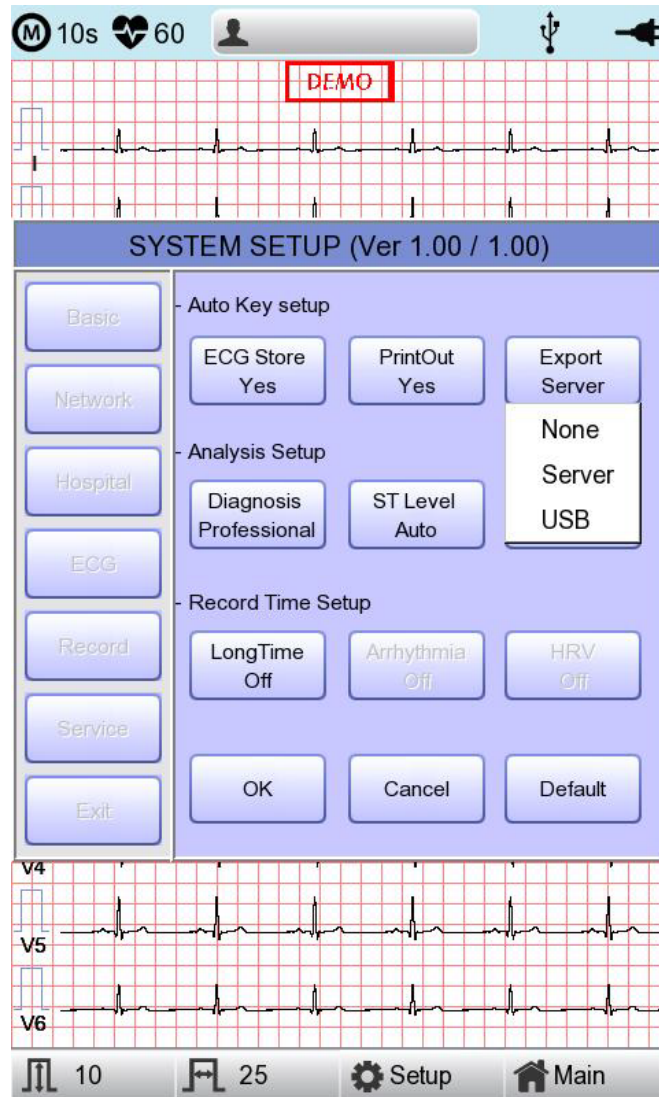

#### Note

When you remove the external device after sending to USB Memory, you

should click icon  that is correct to each device

On top of the main screen and remove the device.  
Otherwise data can be damaged.

## Auto diagnosis setting

'When selecting the 'Diagnosis' menu, a small menu window as below will appear and it will disappear when selecting one of OFF, Standard or Professional.

When 'OFF' is selected, the content of diagnosis will not be printed out, whereas when 'Standard' is selected, the basic information of diagnosis will be printed out at the top of the chart paper, In case of 'Professional', various information of diagnosis will be printed out.

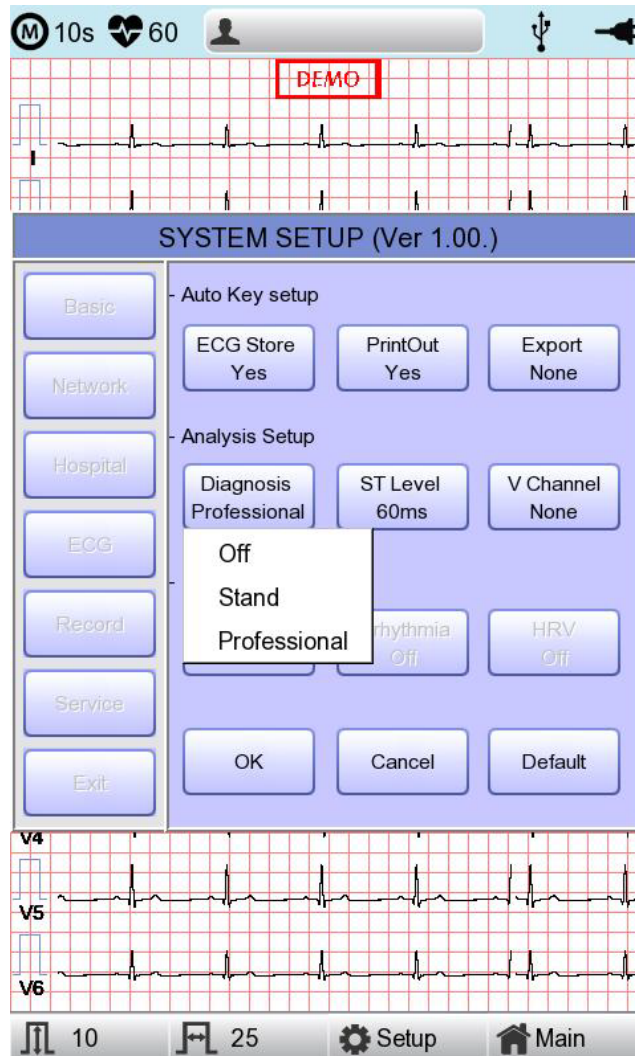

When selecting the 'ST Level' menu, a small menu window as below will appear and it will disappear when selecting one of AUTO, 60msec or 80msec.

When 'AUTO' is selected, J Point associated with ST Level will be automatically set up at the time of printing. When '60msec' is selected, J Point will be set as 60msec and '80msec' for 80msec.

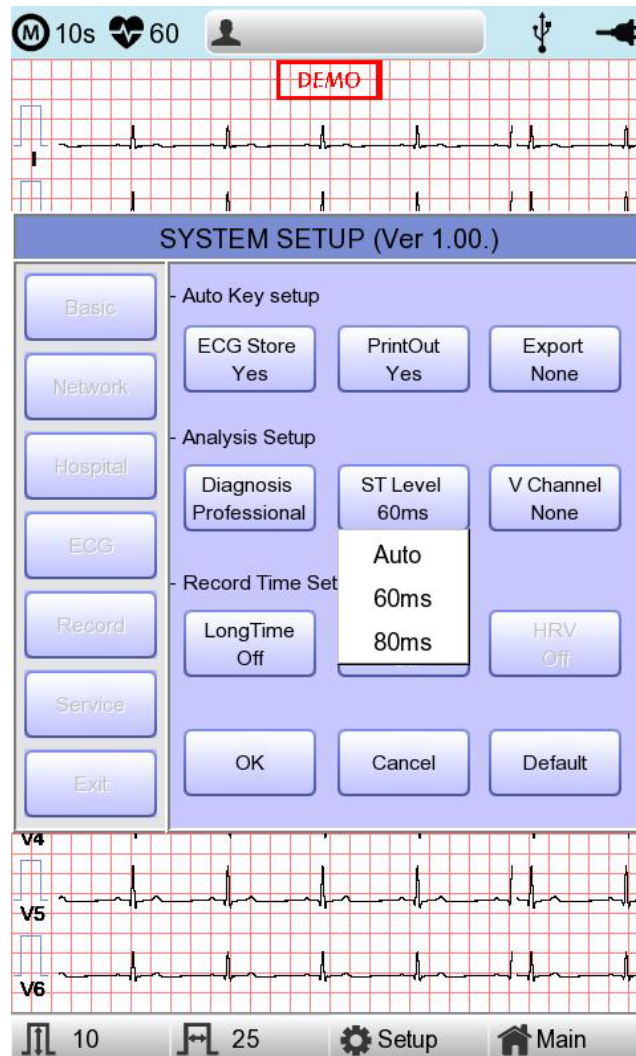

'V Change' menu is used to set up the V3 ~ V6 on the printing paper when diagnosing children in which the location of V3 ~ V6 electrodes need to be changed from left to right.

Basically, the 'V Change' is set as 'None' and when you click this menu, a 'Leads Change' POP-UP window will show up as below. Each time you select the V3R, V4R, V5R or V6R, it will be on or off. When one is selected, the letter R will be seen at the end of the chosen channel (V3 → V3R), otherwise it will not.

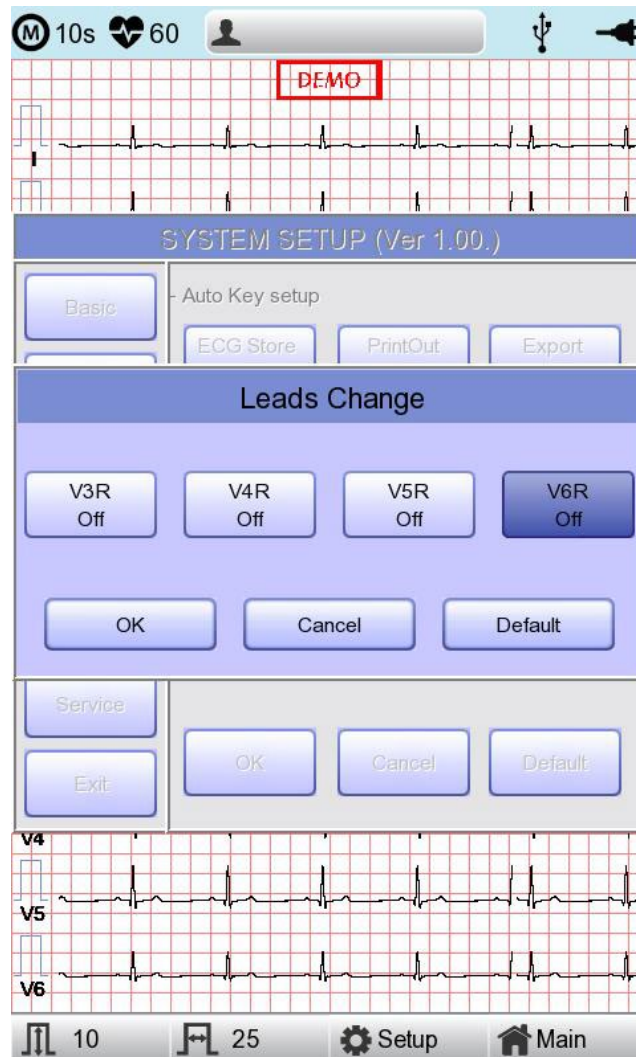

## Long Time setting

Duration of Arrhythmia and HRV recording can be set up. It can be selected as 1, 3, 5 or 10 min.

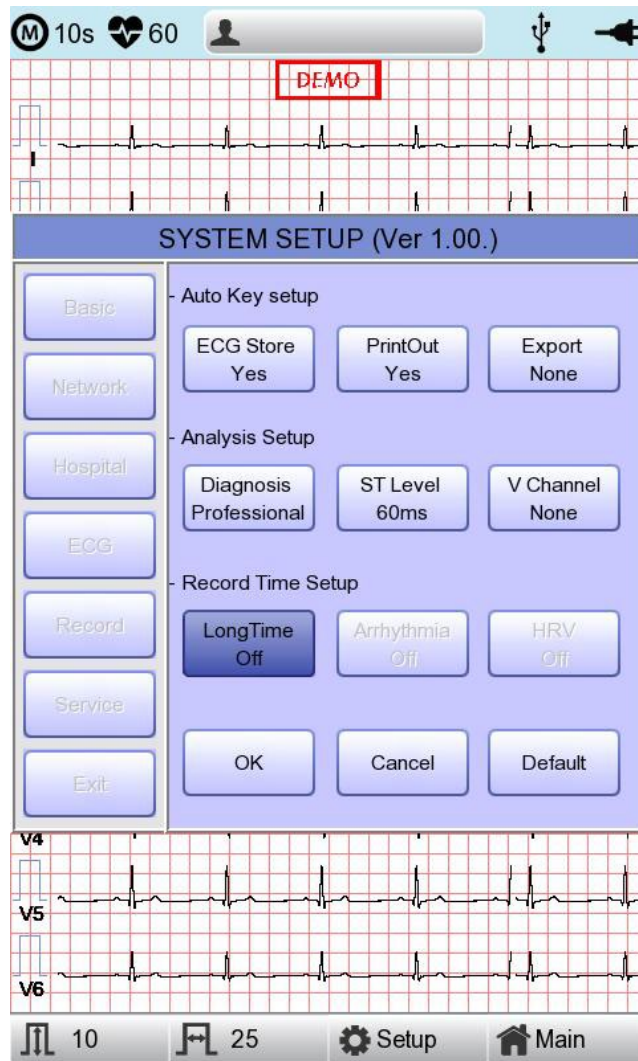

### NOTE

- For Arrhythmia and HRV, only 3, 5 or 10 min are available.
- Upon output of Arrhythmia and HRV, ECG with pre-setup duration will be printed out by one choice of Lead a line at 20-second interval.
- Output will be indicated in increments of 5 mm/mV for gain and in increments of 12.5 mm/sec for speed.

## Arrhythmia setting

When performing Long Time recording, arrhythmia printout options can be configured. If 'Arrhythmia' option is selected as ON, printout will be performed; if OFF, it will not be performed.

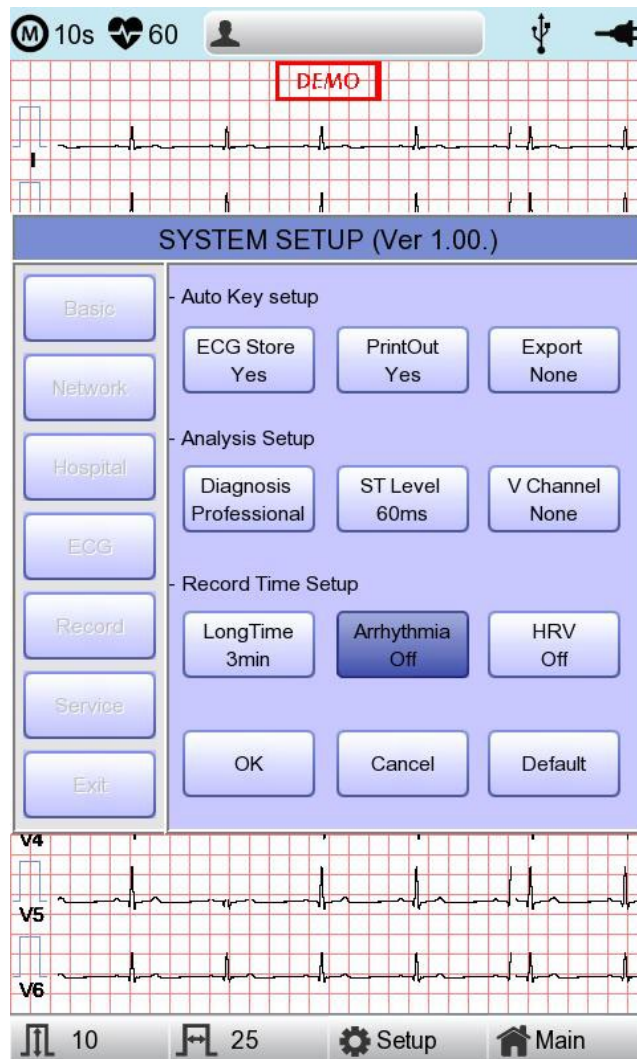

## HRV setting

When performing Long Time recording, HRV printout options can be configured. If 'HRV' option is selected as ON, printout will be performed; if OFF, it will not be performed.

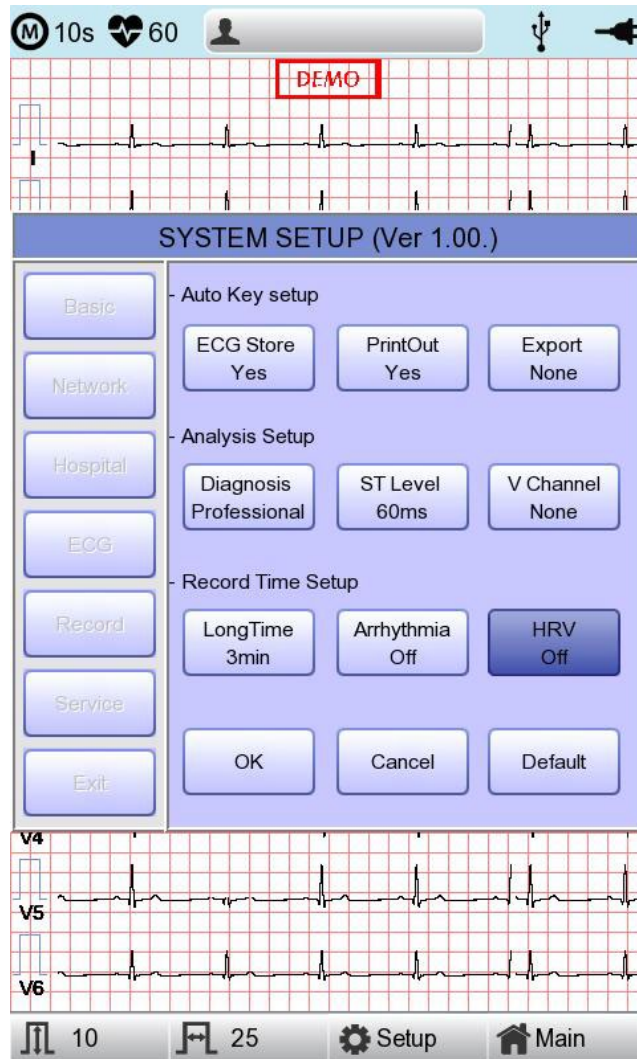

**WARNING**

Do not touch the patient cable or the equipment when using a cardiac defibrillator.

**WARNING**

Please make sure the connector does not touch the conductive parts or the ground when connecting the electrodes or the patient cable.

**WARNING**

The ECG patient cable provided is supposed to use for ECG measuring. Do not use it to measure breathing.

**Caution**

Use the electrodes same as the provided ones or with biocompatibility certificate authorized by the international standard.

**Caution**

When the patient, who had an operation to have a heart assist device, uses Cardio7e/Cardio7, it should be done under the supervision of a health care professional.

## Service Setup

If 'Service' menu on the left of the Setup screen is selected, the other Setup screen related to 'User Security Set' and 'Manufacturer Set' will appear.

At 'User Security Set' setup, it is possible to change Factory Setting and User Password.

At 'Manufacturer Set' setup, it is possible to change Upgrade and Device Options: please contact the Bionet Service center.

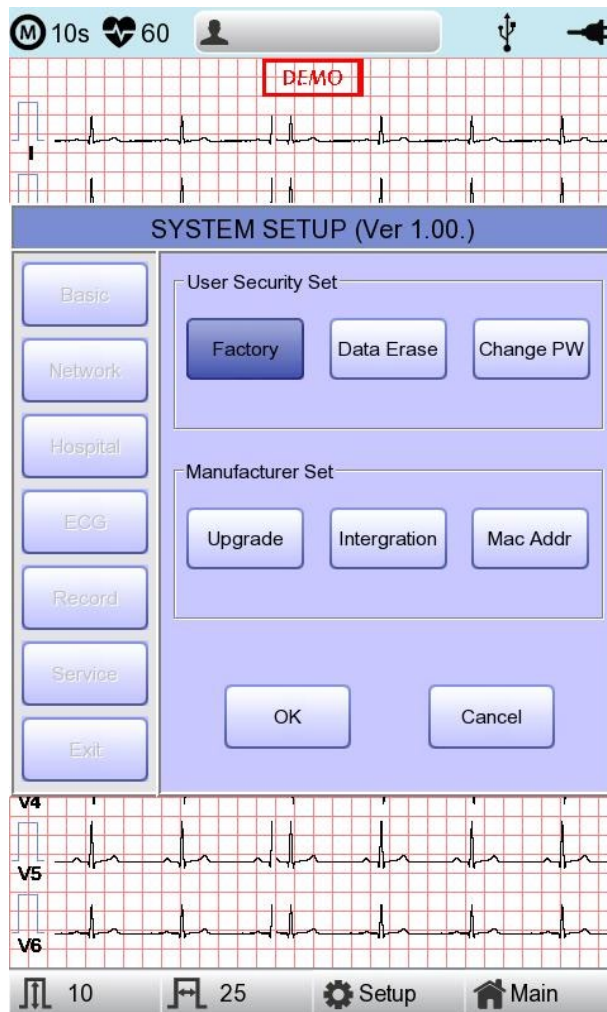

## Factory (Reset Settings)

In order to reset to factory conditions, press the 'Factory' button and enter the Password. Reset will proceed, with the message below appearing on the LCD screen for 1 second.

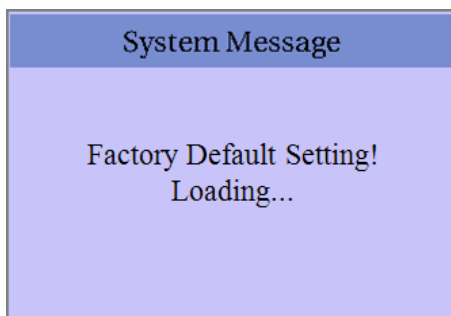

The initialized values are as follows.

Contents	Setting Value
Gain	10mm/mV
Speed	25mm/s
Start Option	Main
Unit	Height: cm, Weight: kg
Date Type	YYYY-MM-DD
Patient Info (File)	Delete
Device Name	Cardio7
Net Device	Wired
Configure	Manually
Device IP	192.168.30.224
Subnet Mask	255.255.255.0
Gate way	192.168.30.1
BMS Server	0.0.0.0
Hospital	blank
Doctor	blank
Preview	On
Quick Print	Off
Lead Fault	On
Pacemaker	Off
QRS sound	Off
Demo	Off
Mon Form	12ch
Mon Size	Continue
Grid	Off

Rec Form	3ch + 3
Paper Size	A4
Print Line	Normal
Beat Form	Off
Rhythm	II, V1, V5
Base Filter	On
AC Filter	For ENG and KOR language, '60Hz' For other languages, '50Hz'
Low Pass Filter	150Hz
EMG Filter	Off
ECG Store	Yes
Print Out	Yes
Export	None
Diagnosis	Professional
ST Level	Auto
V Channel	None
Long Time	Off
Arrhythmia	Off
HRV	Off
Target	PC
Method	Manual
Format	EKG
Delete	Yes
JPEG Size	1024 x 768
Pressure	760mmHg
Humidity	70%
Temp	25°C
Syringe	3000cc
Patient information	initialized

**NOTE**

Even though the system is reset, the 'User password' is not initialized.

## Data Erase

All data in Files and Worklist will be deleted.

For the data erasure function, a password must be entered

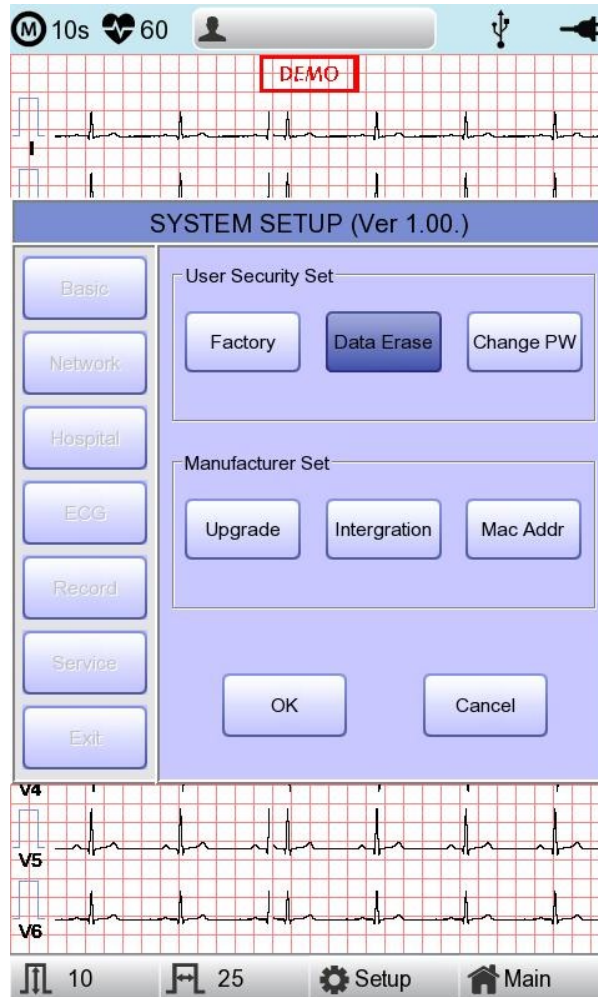

## Change PW

User Password can be configured. User Password is the number entered for Factory and Data Erase. The password should be a 4-digit number.

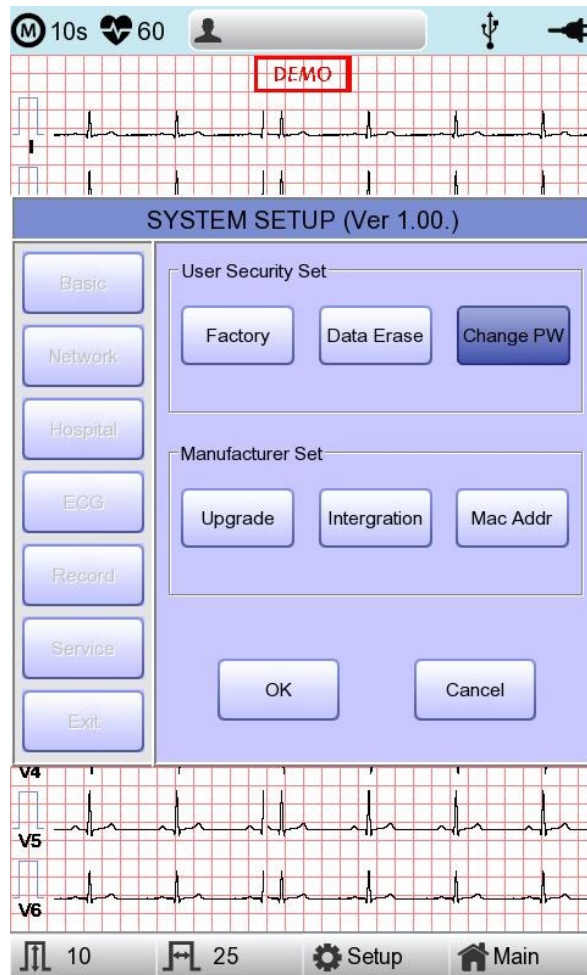

### NOTE

The default User Password is '1234'. If you forget the password, enter '1234' and reset.

## **Chapter 3. ECG file management**

- 1) Display and function**
- 2) Data printing**
- 3) Data deleting**
- 4) System Setup**
- 5) Switching menu**
- 6) Patient information**
- 7) Data search**
- 8) Data transfer**
- 9) Data import**

## 1) Display and function

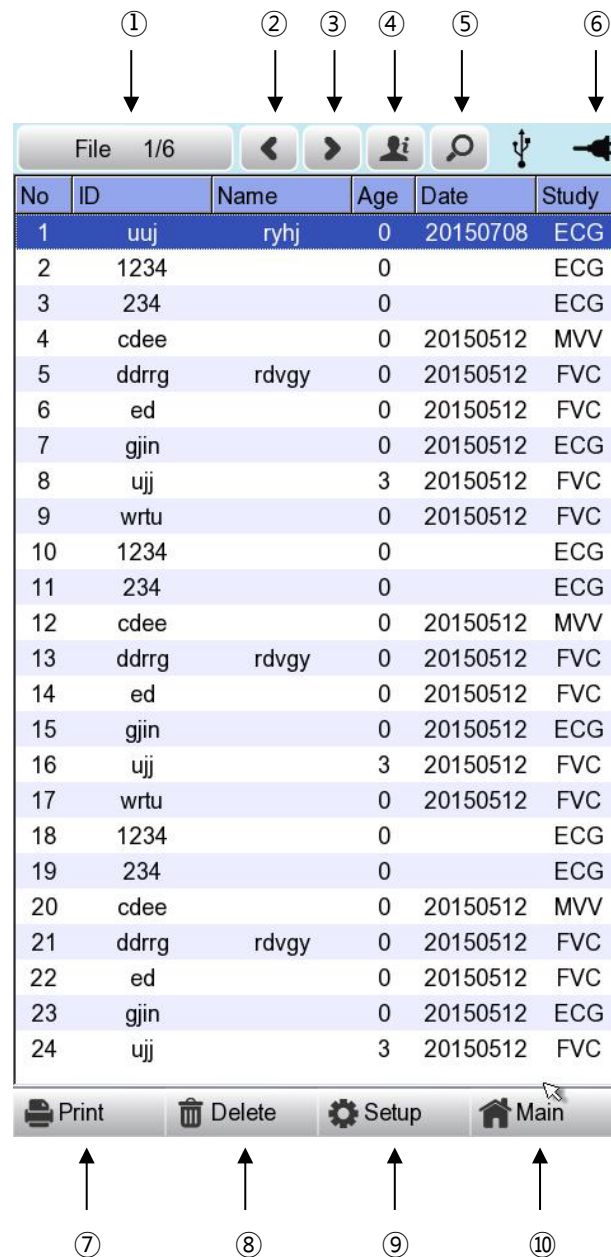

- ① Page information  
- For example, [1/20] means that you see the first page among total 20 pages. 1 Page contains 24 lines of Data.  
If Rotary is selected, the focus will be moved to Data list.
- ② Button to skip to the previous page
- ③ Button to skip to the next page
- ④ Button to check the patient's information of the chosen data saved
- ⑤ Button to search the data you want
- ⑥ State of battery or AC power connection

- ⑦ Button to print out the chosen saved data
- ⑧ Button to delete the data
- ⑨ Button to set up the environment of 'File Management'
- ⑩ Button to move to other main screen from 'File Management'

At the initial file management page, the first data of the list has the focus. The focus will automatically move to the menu bar at the bottom of the screen, when you click the data by touching the screen or rotating the rotary key on the control panel.

If there is no data in the page, the focus can be found on [Print] button.

When there is no patient information you want to select, please press [<] or [>] button or the 'Search' menu to move to other pages.

- Menu direction (Rotary Key's right spin)

Print → Delete → Setup → Main → Page information → [<] → [>] → Info → Search → Print

- Menu direction (Rotary Key's left spin)

Print → Search → Info → [>] → [<] → Page information → Main → Setup → Delete → Print

## 2) Data printing

When selecting a saved data at the ECG file management page by using rotary key or touch screen, the focus will appear at the data list.

Press the 'Print' button to print out the data. Then you will see a message as shown below.

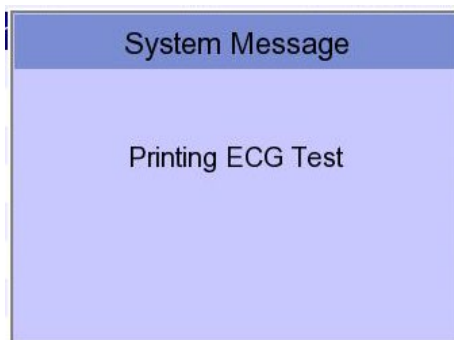

### Note

You should avoid attaching and detaching a USB device while printing out, as it could cause the printer module to rattle.

### 3) Data deleting

When pressing the 'Delete' button, a small pop-up menu will show up. You can choose to press the 'select' or 'all' button.

When you press the 'Select' button, one data will be deleted, but if you press the 'All' button, all data in the list will be deleted.

In order to help the user not to make a mistake when deleting the data, a message shown as below will appear to reaffirm whether you really want to delete the data.

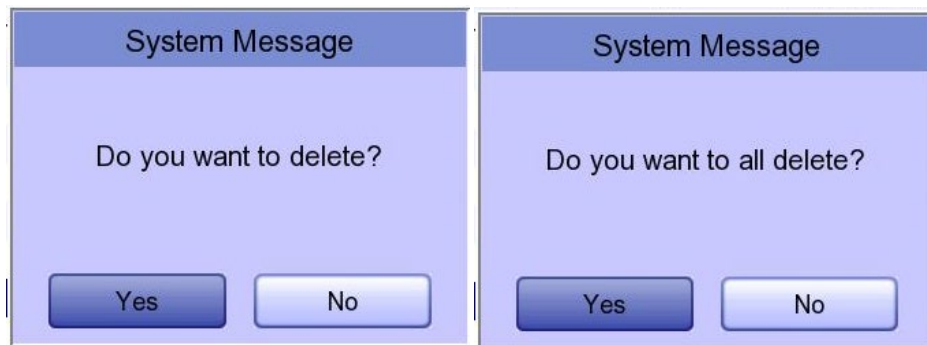

#### Caution

Please think carefully before selecting the 'All' button, as it will permanently delete all of the ECG data.

## 4) System Setup

When clicking the 'Setup' button at the ECG data file management page, you will see a 'System Setup' window as shown below.

No	ID	Name	Age	Date	Study
<b>SYSTEM SETUP (Ver 2.29 / 1.03 (DICOM))</b>					
<b>Basic</b>		Date:	2022	-	05 - 20
<b>Network</b>		Time:	09	:	58 . 53
<b>Hospital</b>		TouchScri	Language	Start Opt.	
<b>FILE</b>		Units	Date Type	PAT Info.	
<b>Export</b>		cm/kg	Y-M-D	Delete	
<b>Service</b>		DeviceName	HMG-EC-0012		
<b>Exit</b>		Device ID	NP000000		
		OK	Cancel	Default	
<span>Print</span> <span>Delete</span> <span>Setup</span> <span>Main</span>					

'PAT Info.' menu is to set up whether the patient information is retained or not, when you move the main screen of the ECG. When you click the menu, 'Retain' will be set up and when clicking the menu again, 'Delete' will be set up. Default is set as 'Delete'.

- 'Delete': To set up the patient information is deleted, when you move to main screen of the ECG.
- 'Retain': To set up the patient information is retained, when you move to main screen of the ECG This may result in more than one record for the same patient.

### Note

The steps for Network, Hospital and Service Setting are identical with the steps for ECG Main setting.

When clicking the 'FILE' button, you will see 'FILE' window as shown below.

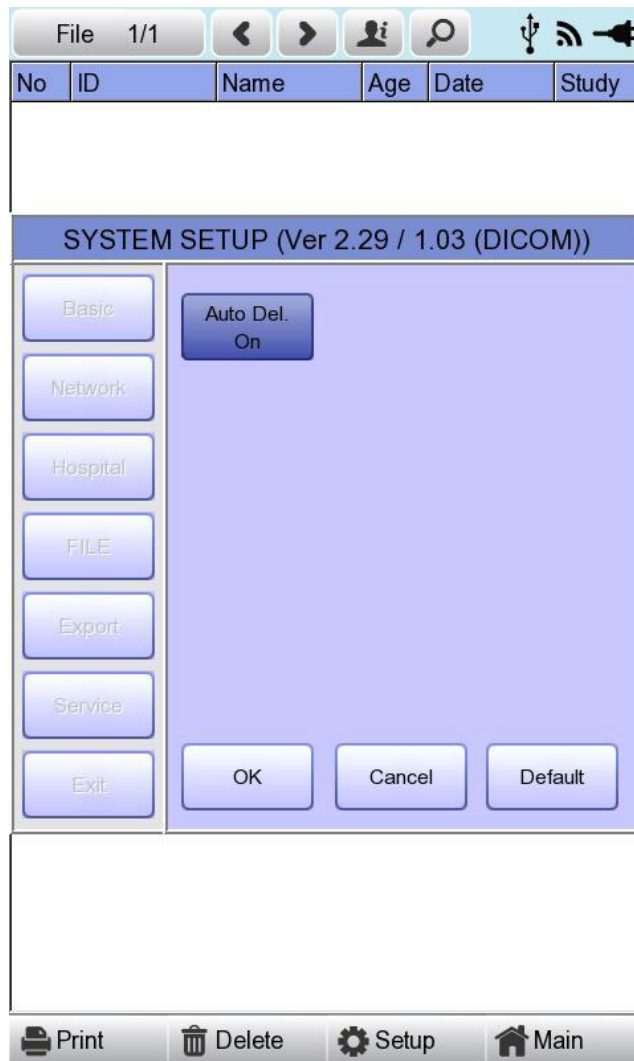

You can activate the automatic deletion function by clicking the 'Auto Del.' menu in the 'FILE' menu window.

When the automatic deletion function is activated, when a new file is saved beyond the maximum storage capacity, the oldest file is deleted and then saved.

When clicking the 'Export' button, you will see 'Export' window as shown below.

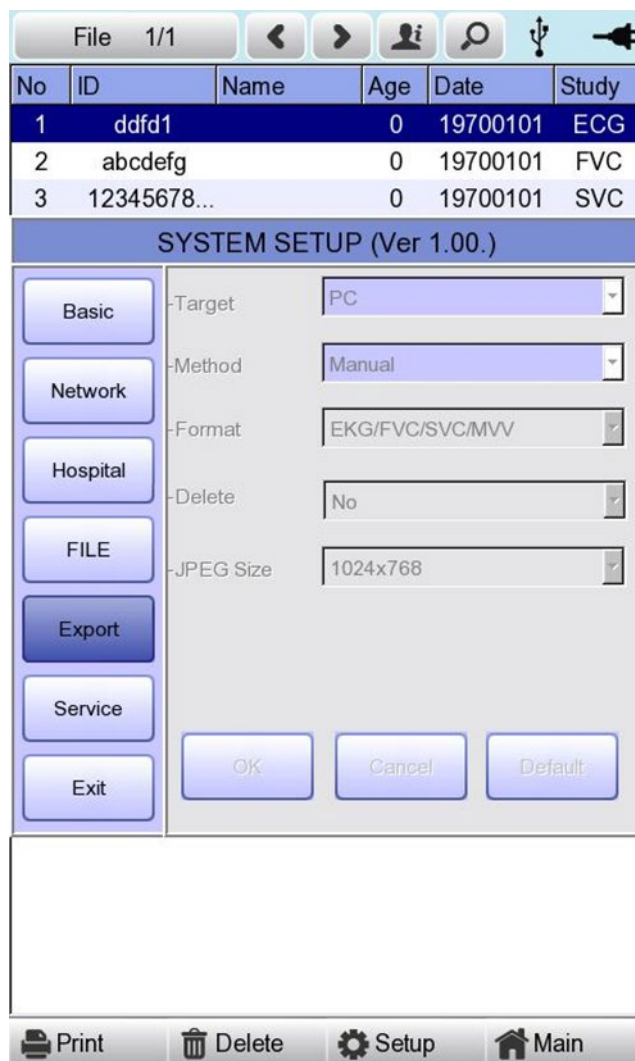

When clicking the 'Target' button, a POP-UP window will show up and it will disappear when selecting one of BMS Server or USB.

- BMS Server/PACS Server  
: To save the data in the BMS Server or PACS Server.
- USB: To save the data in the external USB Memory

When clicking the 'Method' button, a small line window will show up and it will disappear when selecting Manual, Select, All or All New.

- Manual: menu window allows user to select either 'Selected, All, All New, Cancel' or 'Selected, Cancel' whenever transferring data
- Select: To transfer the selected data
- All: To transfer all data
- All New: To transfer the newly saved data

When clicking the 'Format' button, a line window will show up and it will disappear when selecting EKG/FVC/SVC/MVV, MFER(ECG), XML(ECG), JPEG, PDF. 'Format' menu is used to select the user's options when transferring the data.

- EKG/FVC/SVC/MVV: To save the data by type of '\*\*\*.ekg' / '\*\*\*.fvc' / '\*\*\*.svc' / '\*\*\*.mvv'
- MFER: To save the data by type of '\*\*\*.mwf'
- XML: To save the data by type of '\*\*\*.xml'
- JPEG: To save the data by type of '\*\*\*.jpg'
- PDF: To save the data by type of '\*\*\*.pdf'
- DICOM: To save the data by type of '\*\*\*.dcm'

When clicking the 'Delete' button, a line window will show up and it will disappear when selecting Yes or No. 'Delete' menu is used to select the user's options after the data has transferred.

- Yes: To delete the data after it has transferred
- No: To not delete the data after it has transferred

NOTE
- If 'Format' menu has only 'EKG/FVC/SVC/MVV' options, it is possible to select 'All' or 'All New' in 'Method' menu; for other formats, 'Selected' is the only option.

## 5) Switching menu

When selecting the 'Main' button at the main page of 'File management', a line window will show up. You can choose ECG, Spiro or Worklist to go to the chosen page.

The patient's information of selected data does not transmit when skipping to 'Worklist Management' screen. But it depends on the setting value of 'PAT Info.' menu when skipping to 'ECG' main screen.

- ECG: Skip to ECG main screen
- Worklist: Skip to 'Worklist Management' screen
- Spiro: Skip to spirometry measurement screen

## 6) Patient information

When selecting a saved data at the ECG file management page by using a rotary key or a touch screen, the focus will appear at the data list.

Press the 'Info' button. Then you will see a 'Patient Information' window as shown below. Information other than patient name cannot be changed.

No.	ID	Name	Age	Date	Study
24	06262202	nhgk	2	20180628	ECG

**Patient Information**

\* ID: 06262208

Name: fufhr

F. Name:

\* Age: 6 - 26 - 2018 (Date of birth)

\* Gender: Female

\* Height: cm

Weight: kg

\* Race: White

Smoke: No

Department:

Room No:

Study Desc.: ECG

Accession No.: 262208

Ref. Physician: JOHN DOE

## 7) Data search

When clicking the 'Search' button at the ECG data file management page, you will see a 'Patient Search' window as shown below. If you rotate the rotary key, the 'search condition' button will have focus. Press the 'Find' button after inputting the information about ID, Name, Date or Age.

When the search takes a long time, a message will show up to let you know the progress. After searching, you will see a data search result page.

No	ID	Name	Age	Date	Study
1	11270410	phudg	0	20151127	ECG
2	11275510	gqafb	0	20151127	ECG
3	11275510	gqafb	0	20151127	ECG
4	7890	dvvv	32	20151127	FVC

**Patient Search**

Search Condition: ID

- ID:

- Name:

- Day:  -  -  ~

Y-M-D

-  -

- Age:  ~

20	193	193	0	20150720	ECG
21	194	194	0	20150720	ECG
22	189	189	0	20150720	ECG
23	190	190	0	20150720	ECG
24	191	191	0	20150720	ECG

## 8) Data transfer

You can transfer the saved data to the external device at the ECG data file management page by using the 'NETWORK' key on the control panel.

When pressing the 'NETWORK' key, a message will show up, asking which menu you want to select.



If you transfer a selected data, a message with progress speed or other information will be shown as below.

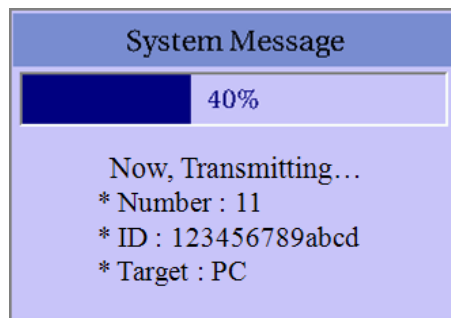

If you transfer all of the data, a message with progress speed or other information will be shown as below. In this case, the total number of files and the file being transferred currently will be displayed.

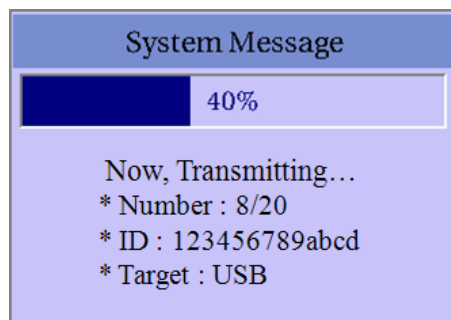

**NOTE**

When transmitting multiple sets of data to PC after saving, a network error could occur which may cause transmission halt and subsequent loss of data. Therefore, we recommend users to practice following procedures to minimize such loss.

1. In EKG Main, press [NET] button to transmit data to PC immediately after measuring.
2. When transmitting multiple sets of measurements, rather than sending all data at once, we recommend users to transmit individual records after each measurement.

**NOTE**

If the system boots up without having LAN cable connected, the network function may not work properly. In this case, enter [System] -> [Network] -> [OK] then press 'NETWORK' button to attempt running the network function again. Please refer Network Setup part of the manual to get more information regarding IP configuration setup.

## 9) Data import

You can import the saved data from the external device at the ECG data file management page by using the 'RECORD' key on the control panel.

When pressing the 'RECORD' key, 'Import File List' screen will be shown as below.

The screenshot displays the 'Import File List' screen. At the top, there is a header bar with 'File 1/1' and navigation icons. Below this is a table with the following data:

No	ID	Name	Age	Date	Study
1	ddfd1		0	19700101	ECG
2	abcdefg		0	19700101	FVC
3	12345678...		0	19700101	SVC
4	dog		0	19700101	MVV
5	abcdefg		0	20000101	MVV

Below the table is a 'FILE LIST MANAGEMENT' dialog box with a table of file names:

No	Name
1	1234567890_19700101002436.SVC
2	111_20140101002029.MVV
3	7hh_20150101053631.MVV
4	abcdefg_19700101000101.FVC
5	abcdefg_20000101001909.MVV
6	abcdefg_20150101011837.MVV
7	ddfd1_19700101000750.ekg
8	1234567890_19700101000045.MVV

At the bottom of the dialog box are three buttons: 'Select', 'All', and 'Close'. Below the dialog box is a large empty white area. At the very bottom of the screen is a footer bar with icons for 'Print', 'Delete', 'Setup', and 'Main'.

If 2 different USB memory devices are connected, a system message window prompting you to select one of them will appear.

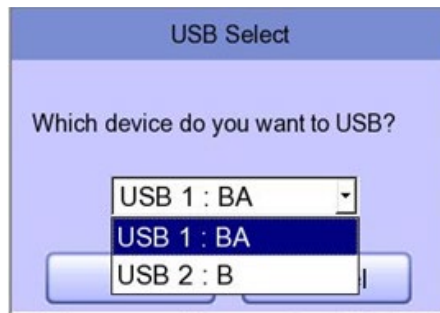

If the external device is not connected to Cardio7e/Cardio7, the error message will be shown as below.



If you select the 'Selected' menu in the 'Import File List' screen, after receiving the selected data from the external device a system message will be shown as below.



If you select the 'All' menu in the 'Import File List' screen, a system message with progress speed will be shown as below.

After receiving all data from the external device, a system message will be shown as below.

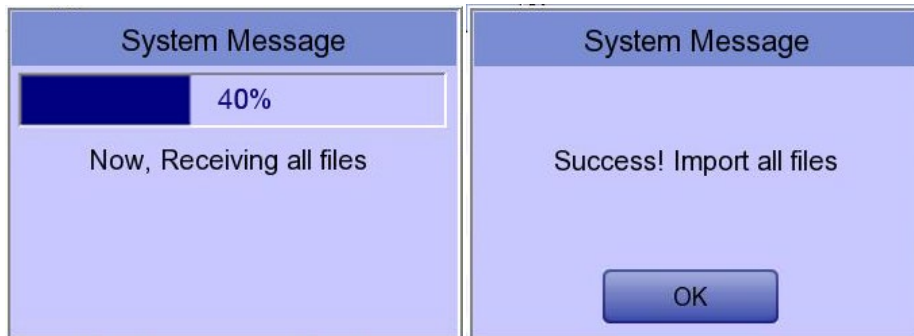

## **Chapter 4. ECG worklist management**

- 1) Display and function**
- 2) ECG Test**
- 3) Data deleting**
- 4) System Setup**
- 5) Switching menu**
- 6) Patient information**
- 7) Data search**

## 1) Display and function

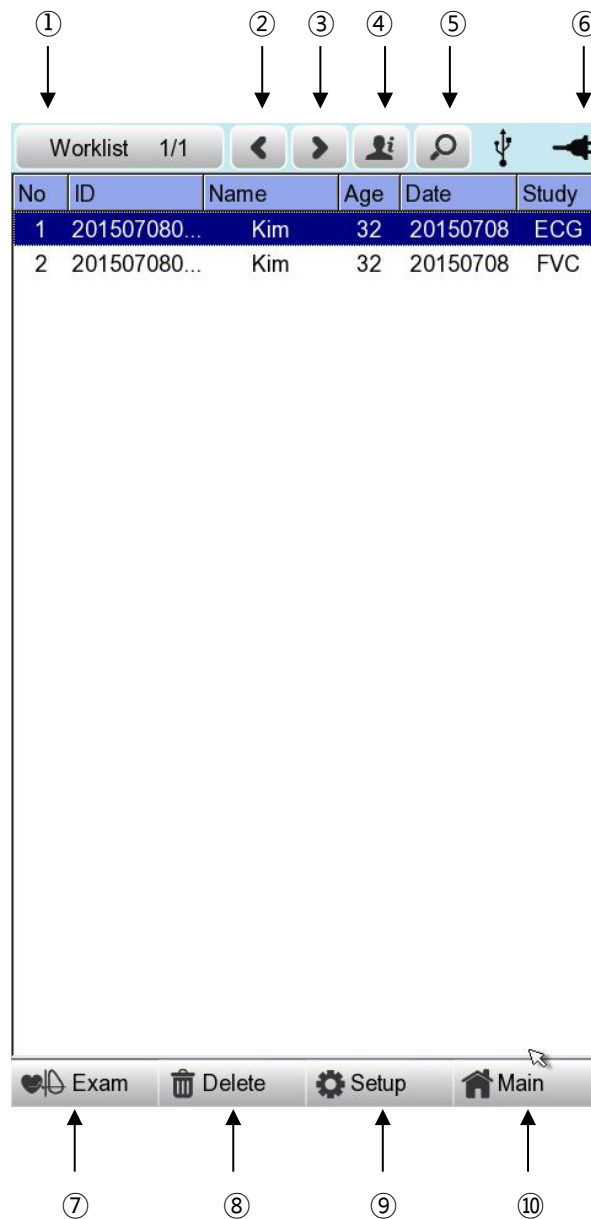

- ① Page information  
- For example, [1/20] means that you see the first page among total 20 pages. 1 Page contains 24 Data.  
If Rotary is selected, the focus will be moved to Data list.
- ② Button to skip to the previous page
- ③ Button to skip to the next page
- ④ Button to check the patient's information of the chosen data saved
- ⑤ Button to search the data you want
- ⑥ State of battery or AC power connection

- ⑦ Go to test window for the requested choice of data
- ⑧ Button to delete the data  
(After interlocking with the PACS Server, press the 'Update' button)
- ⑨ Button to set up the environment of 'Worklist Management'
- ⑩ Button to move to another main screen from 'Worklist Management'

At the initial file management page, the first data of the list has the focus. The focus will automatically move to the menu bar at the bottom of the screen, when you click the data by touching the screen or rotating the rotary key on the control panel.

If there is no data in the page, the focus can be found on [Exam] button.

When there is no patient information you want to select, please press [<] or [>] button or the 'Search' menu to move to other pages.

- Menu direction (Rotary Key's right spin)

Exam → Delete → Setup → Main → Page information → [<] → [>] → Info → Search → Exam

- Menu direction (Rotary Key's left spin)

Exam → Search → Info → [>] → [<] → Page information → Main → Setup → Delete → Exam

We recommend using less than 200 work lists.

## 2) ECG Test

Select 'Exam' button to go ECG main screen in order to start ECG measurement with patient information in the test-requested data list.

There is no need to input additional information, as all of the patient information is already saved upon ECG test.

### Caution

Each functional key action of ECG Main Menu is as follows:

- RECORD: not saving measured data but performing output only.
- NET: not saving measured data but transferring it to a PC.
- AUTO: running according to Auto Key setup of system.

To save measured data for the Test requested, configure **ECG Store on Auto Key setup as Yes**, and then start measurement by pressing the Auto button.

### 3) Data deleting

When pressing the 'Delete' button, a small pop-up menu will show up. You can choose to press the 'select' or 'all' button.

When you press the 'Select' button, one data will be deleted, but if you press the 'All' button, every data in the list will be deleted.

In order to help the user not to make a mistake when deleting the data, a message shown as below will appear to reaffirm whether you really want to delete the data.



#### Caution

Please think carefully before selecting the 'All' button, as it will permanently delete all of the ECG data.

## 4) System Setup

When clicking the 'Setup' button at the ECG data worklist management page, you will see the 'worklist System Setup' window as shown below.

No	ID	Name	Age	Date	Study
<b>SYSTEM SETUP (Ver 1.00.)</b>					
<div style="display: flex; justify-content: space-between;"> <div style="width: 20%;"> <p><b>Basic</b></p> <p>Network</p> <p>Hospital</p> <p>Service</p> <p>Exit</p> </div> <div style="width: 80%;"> <p>Date: 2015 - 07 - 10 Y-M-D</p> <p>Time: 03 : 09 : 24</p> <p>TouchScrn    Lang ENG    Start Opt Main</p> <p>Units cm/kg    Date Type Y-M-D</p> <p>DeviceName Cardio7</p> <p>Device ID NPFFFFFF</p> <p>OK    Cancel    Default</p> </div> </div>					
Exam    Delete    Setup    Main					

### Note

The steps for Network, Hospital and Service Setting are identical with the steps for ECG Main setting.

## 5) Switching menu

When selecting the Main button at the main page of the ECG file management, a line window will show up. You can choose ECG or FILE to go to the chosen page.

The patient's information of selected data does not transmit, when moving to another main screen.

- ECG: skip to ECG main screen
- FILE: skip to 'File Management' screen
- Spiro: skip to spirometry measurement screen

## 6) Patient information

When selecting saved data at the ECG file management page by using rotary key or touch screen, the focus will appear at the data list.

Press the 'Info' button to see the 'Patient Information' page. After checking all of the information, press the OK button and then the 'Patient Information' page will disappear.

The screenshot shows a mobile application interface with a 'Patient Information' form. The form is a light blue overlay with a white background. It contains the following fields and values:

- ID: 06262208
- Name: fufhr
- F. Name: (empty)
- Age: 6 - 26 - 2018 (Date of birth)
- Gender: Female
- Height: (empty) cm
- Weight: (empty) kg
- Race: White
- Smoke: No
- Department: (empty)
- Room No: (empty)
- Study Desc.: ECG
- Accession No.: 262208
- Ref. Physician: JOHN DOE

At the bottom of the form is an 'OK' button. The background shows a 'Worklist' table with columns: No, ID, Name, Age, Date, Study. The table has one row visible with the following data: No: 1, ID: 06262208, Name: fufhr, Age: 6, Date: 26, Study: ECG. The top of the screen shows a navigation bar with 'Worklist 1/1', back, forward, and search icons. The bottom of the screen shows a navigation bar with 'Exam', 'Update', 'Setup', and 'Main' icons.

## 7) Data search

When clicking the 'Search' button at the ECG data order management page, you will see a 'Patient Search' window as shown below. If you rotate the rotary key, the 'search condition' button will have focus.

Press the 'Find' button after inputting the information about ID, Name, Date or Age.

When the search takes a long time, a message will show up to let you know the progress. After searching, you will see a data search result page.

No	ID	Name	Age	Date	Study
1	4567	dfgh	23	20151123	FVC
2	4567	dfgh	23	20151123	SVC
3	4567	dfgh	23	20151123	MVV
4	1234	fghj	45	20151123	FVC

**Patient Search**

Search Condition: ID

- ID:  ID

- Name:  Name

- Day:  -  -  ~

Y-M-D

- Age:  -  ~

Find
Close
All

Exam
 Delete
 Setup
 Main

## **Chapter 5. System Management**

- 1) Maintenance and Cleaning**
- 2) Regular Check-up**
- 3) Trouble Shooting**
- 4) Manufacturer Declaration**

## 1) Maintenance and Cleaning

There are many ways to clean Cardio7e/Cardio7, but it is best to use our recommendation to avoid damage or sanitary issues.

The warranty does not cover problems resulting from the use of harmful substances (unauthorized substances).

### Caution

After cleaning the product, check the hardware and the electrodes.  
Do not use the product if it is damaged or worn.

Rub the product with gauze damp with alcohol about once a month to clean the product as well as the electrodes. Do not use lacquer, thinner, ethylene or oxide. Make sure there is no dust or dirt on the cables and limb and chest electrodes and clean them with wet gauze (40°C/104°F) after use and clean it with clinical alcohol once a week.

Do not submerge the product or the ECG cable into any liquid or detergent. Also make sure there is no liquid in the product or the cable.

### Disposal of your old appliance

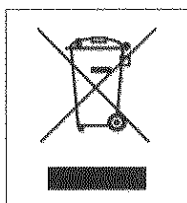

1. When this crossed out wheeled bin symbol is attached to a product it means the product is covered by the European Directive 2002/96/EC.
2. All electrical and electronic products should be disposed of separately from the municipal waste stream via designated collection facilities appointed by the government or the local authorities.
3. The correct disposal of your old appliance will help prevent potential negative consequences for the environment and human health.
4. For more detailed information about disposal of your old appliance, please contact your city office, waste disposal service or the shop where you purchased the product.

## 2) Regular Check-up

Like every other medical product, Cardio7e/Cardio7 requires a regular check-up once a year. Please refer to the Service manual for the information on the check-up.

## 3) Trouble Shooting

- **Printing was not successful:**  
The cover may not be closed properly. Please close the cover and print again.
- **When using the battery power, there was a beep for more than 3 times and a message came as shown below:**



The battery is low. Please connect to the AC power to use.

- **The signal is printed out with noise:**  
First, check that you set up the AC power filter. If it still makes noise with the AC power supply, please connect grounding line to the grounding electrode of the system.  
The grounding should not be used with the AC power's grounding and please connect it to the metal around the patient's bed or the building.
- **When The external USB keyboard is not working properly:**  
Connect the external USB keyboard to the USB port before you turn on the power of Cardio7e/Cardio7. If you connect the external USB keyboard to the USB port after you turn on the power of Cardio7e/Cardio7, you should turn off the power of Cardio7e/Cardio7 and turn on again.

If it is still not working, please contact our customer service center.

- **System messages**

The following system messages may occur while you are operating this system. You may be required to perform some action. If you perform the recommended actions and the condition still remains, contact authorized service personnel.

No.	System message	Cause	Solution
1	Please check date and time	Internal coin battery is discharged.	Please contact CS (Customer Support) team of Bionet to replace old coin type battery with new one
2	Address is not valid	When wrong network Address (IP, SM, GW) is entered	Check the right network address before input
3	Invalid value. [Use: 0~9, A~F]	When wrong character is entered at time of inputting Mac address	Please input valid character such as 0~9, A to F in number and alphabet respectively
4	There is no patient ID. Please enter patient ID.	When you implement AUTO or NET button without patient ID	Please enter patient ID in patient information window to implement
5	Wrong password. Please re-enter your password.	When wrong password is entered	Check and input right password
6	Enter password length error. Please re-enter your password	When wrong number of characters be entered as password	Please check and input valid and correct password
7	The internal memory is full. Please erase other files or transfer to external storage.	When over 200 files are stored at internal memory	Erase files in File menu
8	Not enough free disk space	USB memory device has insufficient space to receive files.	Remove unnecessary files from USB memory (Minimum 500KB space is needed to export 1 file)
9	Please check the USB memory.	When USB memory stick is not inserted, or is out of order	Please check and insert USB memory stick in right position. Note that USB memory file format supports FAT, FAT32 only (this can be checked on PC)
10	There is no Access Point. Please check the AP	There is no wireless access point detected.	Check AP and retry
11	Fail, connecting. Do you want to retry?	When wireless AP connection is failed	- Press Retry button - Retry after checking AP

12	Ping: Failed	When there is connecting failure between network and PC with BMS Server	-Check System setup and network - Check PC network setup -Check LAN cable or wireless environment
13	Verify: C-Echo Failed	When there is failure between PACS Server PC and network	- Check system setup and network - Check PC network setup -Check LAN cable or wireless environment -Please check PACS programs are working
14	IP address conflict.	The devices IP address is already in use on the network	Please contact 'Network Team' to check IP address, and set right IP in turn of System setup and Network
15	Connection Error. Check Lan cable, network setting and relevant program.	When there is failure of network connection	Please check LAN cable connection, network setting, server PC's networking and related S/W programs
16	File Trans Fail!!	When file transmission to server PC or USB memory fails	Check server PC's networking conditions, and USB memory, and retry
17	Check Worklist Server IP	When server IP of PACS worklist is not input	Input server IP of PACS worklist in turn of System setup, Network and PACS setting
18	Check Device AE Title	When AE Title of device is not input	Input AE title of device in turn of System setup, Network and PACS setting
19	Check Device Port	When port of device is not input	Input port of device in turn of System setup, Network and PACS setting
20	Check Worklist Server Port	When server port of PACS Worklist server is not input	Input server port of PACS Worklist server in turn of System setup, Network and PACS setting
21	Check Store AE Title	AE title of PACS store server is not input	Input AE title of PACS store server in turn of System setup, Network and PACS setting
22	Fail to send Image	When file transmission to PACS store server has failed	Retry after checking network conditions
23	Fail to connect Store Server	When there is connection failure between PACS store server and device	Check network condition with PACS store server

24	Transmission failed file is existing. Are you sure to delete?	When the transmission failed file to PACS store server needs to be deleted	Delete the failed file after transmitting the file to PACS store server
25	Recharge Battery!	When the battery level is Low	Please connect power cable or charge battery
26	Printer: Time out.	Printer stops working due to technical problem of device	React the printer
27	Printer: Busy continue	When the wrong printer data were input	React the printer
28	Printer: Temperature high	When the Printer gets heated due to long and continuous use of printer	Please stop the use of printer for at least one minute and try again
29	Printer: Paper empty	When the printing paper is completely out	Please put new roll of printing paper for use
30	Printer: Printer not ready	When there is no 'ready' answer from printer module	React the printer
31	Printer: Unknown data	When the wrong protocol was put into the printer	React the printer
32	Abnormal End!	When the printer was abnormally forced to stop during printing	Re-start printing
33	Lead Fault!	When the lead is off from the patient body	Please reattach the electrode on patient body
		When the conductivity between patient body and electrode is weak	Apply some water to reusable electrodes, and reattach them
34	No ECG Recorded Data!	When the user tries to execute copy printing without any recording data	Try make copy after recording data by "RECORD", "AUTO", and "NET" button

## 4) Manufacturer Declaration

### Electromagnetic Compatibility Information

Phenomenon	Basic EMC standard or test method	Test level/requirement
Mains terminal disturbance voltage	CISPR 11	Group1, Class A
Radiated disturbance	CISPR 11	Group1, Class A
Harmonic Current Emission	IEC 61000-3-2	Class A
Voltage change, Voltage fluctuations and Flicker Emission	IEC 61000-3-3	Pst: 1 Plt: 0.65 Tmax:0.5 dmax: 4% dc: 3.3%
Electrostatic Discharge Immunity	IEC 61000-4-2	± 8 kV/Contact ± 2, ± 4, ± 8, ± 15 kV/Air
Radiated RF Electromagnetic Field Immunity	IEC 61000-4-3	3 V/m 80 MHz - 2.7 GHz 80% AM at 1 kHz
Immunity to Proximity Fields from RF wireless Communications Equipment	IEC 61000-4-3	Table 9 in IEC 60601-1-2: 2014
Electrical Fast Transient/Burst Immunity	IEC 61000-4-4	± 2 kV, 100 kHz repetition frequency ± 1 kV, 100 kHz repetition frequency
Surge Immunity	IEC 61000-4-5	Line to Line ± 0.5 kV, ± 1 kV Line to Ground ± 0.5 kV, ± 1 kV, ± 2 kV

Immunity to Conducted Disturbances Induced by RF fields	IEC 61000-4-6	3 V 0.15 MHz - 80 MHz  6 V in ISM bands Between 0.15 MHz and 80 MHz  80% AM at 1 kHz
Power Frequency Magnetic Field Immunity	IEC 61000-4-8	30 A/m 50 Hz and 60 Hz
Voltage dips	IEC 61000-4-11	0 % $U_i$ ; 0.5 cycle At 0°, 45°, 90°, 135°, 180°, 225°, 270° and 315°
		0 % $U_i$ ; 1 cycle and 70 % $U_i$ ; 25/30 cycles Single phase: at 0°
Voltage interruptions	IEC 61000-4-11	0 % $U_i$ ; 250/300 cycle

### Electromagnetic compatibility\_ Guidance and manufacturer's declaration

Guidance and manufacturer's declaration – electromagnetic emissions		
The Cardio7e/Cardio7 is intended for use in the electromagnetic environment specified below. The customer or the user of the Cardio7e/Cardio7 should assure that it is used in such an environment.		
Emissions test	Compliance	Electromagnetic environment - guidance
RF emissions CISPR 11	Group 1	The Cardio7e/Cardio7 uses RF energy only for its internal function. Therefore, its RF emissions are very low and are not likely to cause any interference in nearby electronic equipment.
RF emissions CISPR 11	Class A	The Cardio7e/Cardio7 is suitable for use in all establishments other than domestic, and may be used in domestic establishments and those directly connected to the public low-voltage power
Harmonic emissions IEC 61000-3-2	Class A	

Voltage fluctuations/ flicker emissions IEC 61000-3-3	Complies	<p>supply network that supplies buildings used for domestic purposes, provided the following warning is heeded:</p> <p><b>Warning:</b> This equipment/system is intended for use by healthcare professionals only.</p> <p>This equipment/system may cause radio interference or may disrupt the operation of nearby equipment. It may be necessary to take mitigation measures, such as re-orienting or relocating the Cardio7e/Cardio7 or shielding the location.</p>
---	----------	--

<b>Guidance and manufacturer's declaration – electromagnetic immunity</b>			
The Cardio7e/Cardio7 is intended for use in the electromagnetic environment specified below. The customer or the user of the Cardio7e/Cardio7 should assure that it is used in such an environment.			
<b>IMMUNITY test</b>	<b>IEC 60601 test level</b>	<b>Compliance level</b>	<b>Electromagnetic environment - guidance</b>
Electrostatic discharge (ESD) IEC 61000-4-2	± 6 kV contact ± 8 kV air	± 6 kV contact ± 8 kV air	Floors should be wood, concrete or ceramic tile. If floors are covered with synthetic material, the relative humidity should be at least 30 %.
Electrical fast transient/burst IEC 61000-4-4	± 2 kV for power supply lines ± 1 kV for input/output lines	± 2 kV for power supply lines ± 1 kV for input/output lines	Mains power quality should be that of a typical commercial or hospital environment.
Surge IEC 61000-4-5	± 1 kV line(s) to line(s) ± 2 kV line(s) to earth	± 1 kV line(s) to line(s) ± 2 kV line(s) to earth	Mains power quality should be that of a typical commercial or hospital environment.
Voltage dips, short interruptions and voltage variations on power supply input lines IEC 61000-4-11	<5%UT (>95%dip in UT) for 0,5 cycle 40 %UT (60 %dip in UT) for 5, 6 cycles 70 %UT (30 %dip in UT) for 25,30 cycles <5%UT (>95%dip in UT) for 5 s	<5%UT (>95%dip in UT) for 0,5 cycle 40 %UT (60 %dip in UT) for 5, 6 cycles 70 %UT (30 %dip in UT) for 25,30 cycles <5%UT (>95%dip in UT) for 5 s	Mains power quality should be that of a typical commercial or hospital environment. If the user of the Cardio7e/Cardio7 requires continued operation during power mains interruptions, it is recommended that the Cardio7e/Cardio7 be powered from an uninterruptible power supply or a battery.

Power frequency (50/60 Hz) magnetic field IEC 61000-4-8	3 A/m	3 A/m	Power frequency magnetic fields should be at levels characteristic of a typical location in a typical commercial or hospital environment.
NOTE $U_T$ is the a. c. mains voltage prior to application of the test level.			

<b>Guidance and manufacturer's declaration – electromagnetic immunity</b>			
The Cardio7e/Cardio7 is intended for use in the electromagnetic environment specified below. The customer or the user of the should assure that it is used in such an environment.			
<b>IMMUNITY test</b>	<b>IEC 60601 test level</b>	<b>Compliance level</b>	<b>Electromagnetic environment - guidance</b>
Conducted RF IEC 61000-4-6	3 Vrms 150 kHz to 80MHz	3 V rms	<p>Portable and mobile RF communications equipment should be used no closer to any part of the Cardio7e/Cardio7, including cables, than the recommended separation distance calculated from the equation applicable to the frequency of the transmitter.</p> <p><b>Recommended separation distance</b></p> $d = \left[ \frac{3,5}{V_1} \right] \sqrt{P}$ $d = \left[ \frac{3,5}{E_1} \right] \sqrt{P} \quad 80 \text{ MHz to } 800 \text{ MHz}$ $d = \left[ \frac{7}{E_1} \right] \sqrt{P} \quad 800 \text{ MHz to } 2,5 \text{ GHz}$ <p>where <math>P</math> is the maximum output power rating of the transmitter in watts (W) according to the transmitter manufacturer and <math>d</math> is the recommended separation distance in meters (m).</p> <p>Field strengths from fixed RF transmitters, as determined by an electromagnetic site survey, <sup>a</sup> should be less than the compliance level in each frequency range. <sup>b</sup></p> <p>Interference may occur in the vicinity of equipment marked with the following symbol:</p> 
Radiated RF IEC 61000-4-3	3 V/m 80 MHz to 2,5 GHz	3 V/m	
NOTE 1 At 80 MHz and 800 MHz, the higher frequency range applies.			
NOTE 2 These guidelines may not apply in all situations. Electromagnetic propagation is affected by absorption and reflection from structures, objects and people.			

- <sup>a</sup> Field strengths from fixed transmitters, such as base stations for radio (cellular/cordless) telephones and land mobile radios, amateur radio, AM and FM radio broadcast and TV broadcast cannot be predicted theoretically with accuracy. To assess the electromagnetic environment due to fixed RF transmitters, an electromagnetic site survey should be considered. If the measured field strength in the location in which the Cardio7e/Cardio7 is used exceeds the applicable RF compliance level above, the Cardio7e/Cardio7 should be observed to verify normal operation. If abnormal performance is observed, additional measures may be necessary, such as re-orienting or relocating the Cardio7e/Cardio7.
- <sup>b</sup> Over the frequency range 150 kHz to 80 MHz, field strength should be less than 3 V/m

### Recommended separation distances between portable and mobile RF communications equipment and the Cardio7e/Cardio7

The Cardio7e/Cardio7 is intended for use in an electromagnetic environment in which radiated RF disturbances are controlled. The customer or the user of the Cardio7e/Cardio7 can help prevent electromagnetic interference by maintaining a minimum distance between portable and mobile RF communications equipment (transmitters) and the Cardio7e/Cardio7 as recommended below, according to the maximum output power of the communications equipment.

Rated maximum output power of transmitter [W]	Separation distance according to frequency of transmitter [m]		
	150 kHz to 80 MHz	80 MHz to 800 MHz	800 MHz to 2,5 GHz
	$d = \left[ \frac{3,5}{V_1} \right] \sqrt{P}$	$d = \left[ \frac{3,5}{E_1} \right] \sqrt{P}$	$d = \left[ \frac{7}{E_1} \right] \sqrt{P}$
	V1=3 Vrms	E1= 3 V/m	E1=3 V/m
0.01	0.12	0.12	0.23
0.1	0.37	0.37	0.74
1	1.17	1.17	2.33
10	3.69	3.69	7.38
100	11.67	11.67	23.33

For transmitters rated at a maximum output power not listed above, the recommended separation distance  $d$  in meters (m) can be estimated using the equation applicable to the frequency of the transmitter, where  $P$  is the maximum output power rating of the transmitter in watts (W) according to the transmitter manufacturer.

NOTE 1 At 80 MHz and 800 MHz, the separation distance for the higher frequency range applies.

NOTE 2 These guidelines may not apply in all situations. Electromagnetic propagation is affected by absorption and reflection from structures, objects and people.

## Chapter 6. Specification

<b>ECG Leads</b>	Simultaneous 12 Leads Resting ECG
<b>Recording Channel</b>	3CH+1RH, 3CH+3RH, 6CH+1RH, 12CH, 6CH+ST map 1CH Long Time (1min, 3min, 5min, 10min) and Special Beat Report (Text, Guide, Vector, ST map)
<b>Gain</b>	2.5, 5, 10, 20, Auto (I~aVF: 10, V1~V6: 5) mm/mV
<b>Printing Speed</b>	5, 12.5, 25, 50, 100 mm/sec
<b>Sampling Rate</b>	Analysis Sampling Rate - 500 Digital Sampling Rate - 8,000
<b>Filters</b>	AC (50/60 Hz, -20dB or better), Muscle (25~35Hz, -3dB or better), Baseline drift (0.05Hz, 0.1Hz, 0.2Hz, -3dB or better), Low pass filter (off, 40Hz, 100Hz, 150Hz)
<b>Display</b>	800 x 480-pixel resolution, 7" Color TFT wide display 12 channels preview, ID, HR, Gain, Speed, Power status
<b>User Interface</b>	Touch screen, Rotary push-knob
<b>Printer Resolution</b>	Thermal print head, Roll Paper Report paper - width: A4/Letter 215mm (8.5") - length: A4 297 mm (11.7") Letter 279mm (11")  Resolution: 8dot/mm (0.125mm pitch)
<b>Patient data</b>	ID, name, age, gender, height, weight, race, smoke, department, room number, study desc., accession no., referring physician
<b>Basic Measurement</b>	Heart rate (30~300bpm, $\pm 3$ bpm), PR/RR int., QRS dur., QT/QTc int., P-R-T axis, SV1/RV5/R+S amp.
<b>ECG Data Storage</b>	Internal Storage for 200 ECGs: Built-in memory
<b>Electrical</b>	Internal noise: 20 $\mu$ V(p-p) max Input impedance: $\geq 50M\Omega$ Input voltage range: $\pm 5$ mV CMRR: > 105dB DC offset voltage: $\geq \pm 400$ mV Patient leakage current: < 10 $\mu$ A Frequency response: 0.05 ~ 200 with in -3dB Isolated, defibrillation and ESU protected
<b>Signal Quality Control</b>	Pacemaker pulse detection Lead fault detection, Signal Saturation Detection
<b>Line Power</b>	Input: 100-240Vac, 1.5-0.75A, 50-60Hz, Output: 15Vdc, 4.2A

<b>Battery type</b>		Replaceable and Rechargeable, Lithium ion, 10.8V, 3250mA
<b>Battery Capacity</b>		6 hours of normal use or print 200 ECG pages (12 channel format at 25mm/s and 10mm/mV) The battery will charge to its full capacity within 3 hours with the power off.
<b>Communication</b>		LAN, WIFI (option), USB flash driver, USB barcode scanner
<b>Safety Conformity</b>		Class I, Type CF defibrillation-proof applied part.
<b>Environmental</b>	<b>Operation</b>	Ambient Temperature: 10~40°C Relative Humidity: 30~85%RH Atmospheric Pressure: 70~106KPa
	<b>Storage/Ship</b>	Ambient Temperature: -20~60°C Relative Humidity: 10~95%RH Atmospheric Pressure: 50~106KPa
<b>Dimensions</b>		300(W) x 290(D) x 89.5(H) mm, Approx. 3.5 kg
<b>Standard Accessory</b>		Patient cable (1 EA), Limbs electrodes (1 SET), Chest electrodes (1 SET), ECG chart paper (1 EA), Power cord (1 EA), ECG Gel (1 EA) Operation manual & ECG diagnosis guide (1EA)
<b>Options</b>		Rechargeable battery (1 EA),

## WARRANTY

Product Name	Electrocardiograph
Model Name	Cardio7e/Cardio7
License Number	
License Date	
Serial Number	
Warranty period	1 year from the date of purchase
Date of purchase	(yyyy/mm/dd)
Customer	Hospital: Address: Name: Contact No:
Seller's Name	
Manufacturer's Name	

- ※ Thanks for purchasing Cardio7e/Cardio7.
- ※ This product is a medical machine.
- ※ This product meets the strict quality requirements thoroughly.
- ※ The repairing and compensation standards follow the consumer damage compensation regulations of the Ministry of Finance and Economy.



## Headquarters & International Sales & service

### Bionet Co., Ltd.:

5F, 61 Digital-ro 31 gil, Guro-gu, SEOUL

08375, REPUBLIC OF KOREA

Tel: +82-2-6292-6410 / Fax: +82-2-6499-7789 / E-mail: sales@ebionet.com

Website: [www.ebionet.com](http://www.ebionet.com)

## U.S.A sales & service representative

### Bionet America, Inc.:

2691, Dow Ave, Suite B

Tustin, CA92780 U.S.A.

Toll Free: 1-877-924-6638 / Fax: 1-714-734-1761 / E-mail: support@bionetus.com

Website: [www.bionetus.com](http://www.bionetus.com)

## European sales & service representative

### Bionet Europe GmbH

2Li Bessemerstr. 51,

D-12103 Berlin, Germany

Tel: +49-30-240-374-52 / E-mail: bionetEU@ebionet.com

Website: [www.ebionet.com](http://www.ebionet.com)

L※ 'CE1434' only supports Cardio7e equipment.



1434

**Bionet Co., Ltd**

Model Name: Cardio7e/Cardio7(ECG)